



CLASSIC

11014







- 1 Scan the code on the front cover
Scanne den Code auf der Titelseite
Scanne le code sur la page de couverture
Scanner le code sur la page couverture
Scansiona il codice sulla copertina
Escanea el código de la portada
Faz scan do código na frente da capa
Olvasd be a borítón látható kódot!
Noskenë kodu uz priekšējā vāka
扫描封面上的二维码



- 2 Get Instructions PLUS
Hol dir Instructions PLUS
Obtiens les instructions PLUS
Obtenir les Instructions PLUS
Scarica Instructions PLUS
Descubre Instructions PLUS
Obtém Instruções PLUS
Szerezd be az Instructions PLUS kiegészítőt!
Saņem "Instructions PLUS"
获取更多说明

LEGO.com/apps

Check for compatibility
Kompatibilität prüfen
Vérifier la compatibilité
Controlla la compatibilità
Comprueba tu compatibilidad

Verificar a compatibilidade
Ellenőrizd a kompatibilitást
Pārbaudīt saderību
检查兼容性

Page
11



Page
7



Page
22





Page
31



Page
39



Page
46



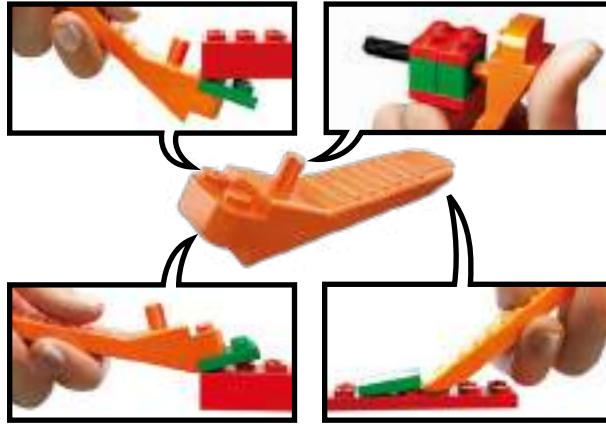

LEGO.com/brickseparator

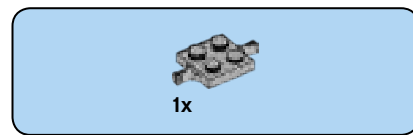
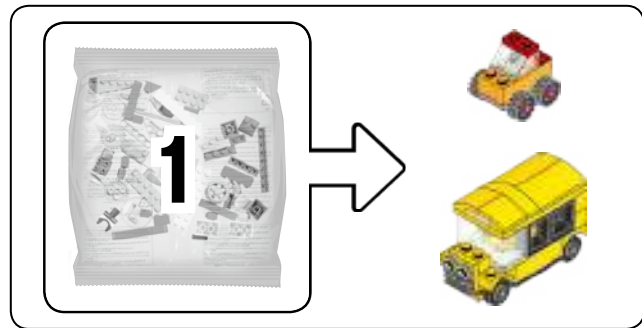

1





1x

2

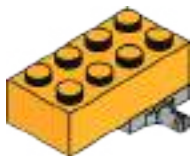

1x

3



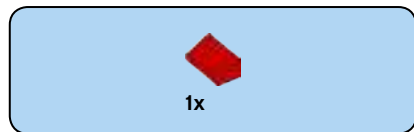

4

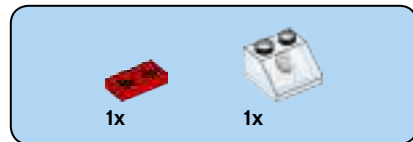

5

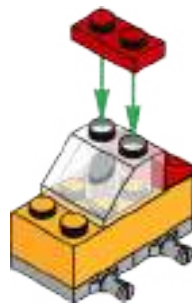



6

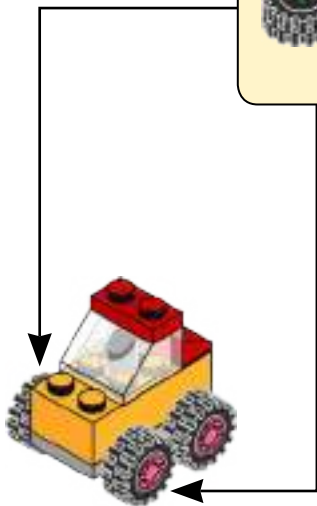
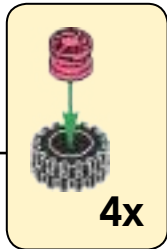

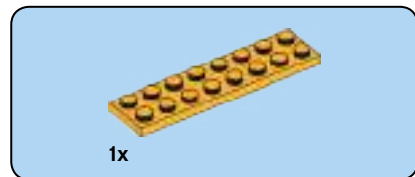

1

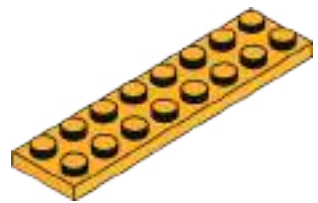

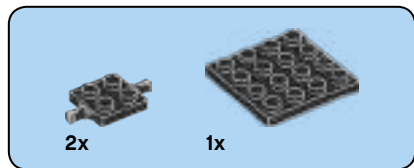

2

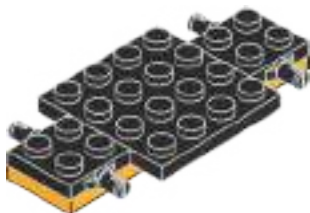



3

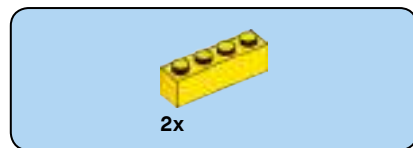
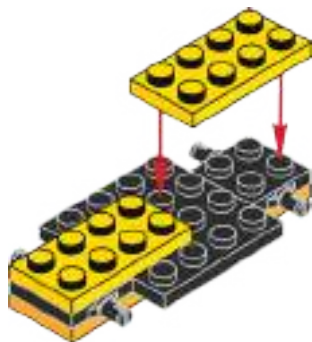

4

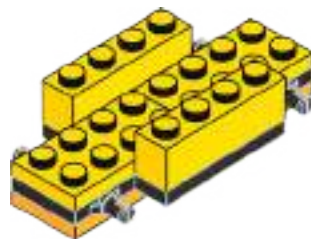



2x

5

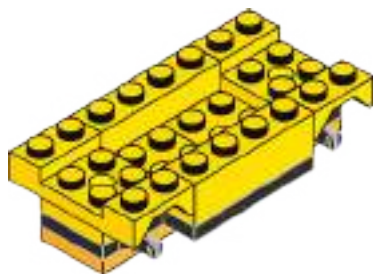



2x



1x

6

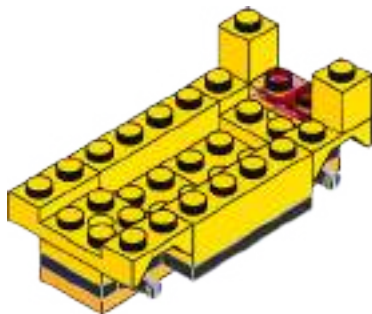

2x



1x

7

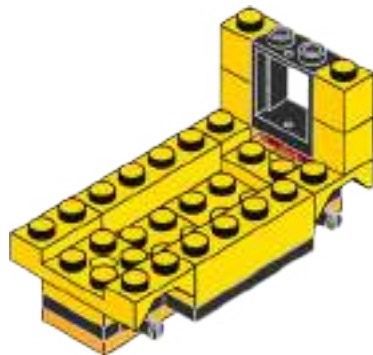



4x

8

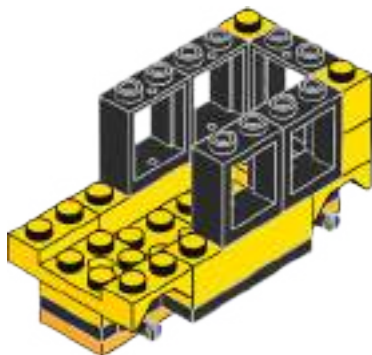

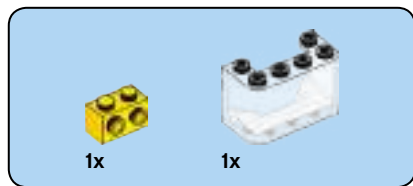

9

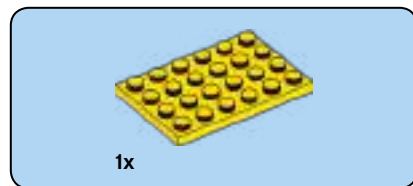

10





1x

11



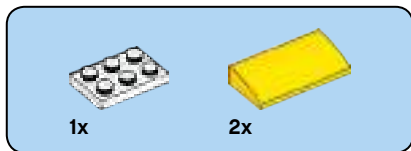

12



13





1x

14

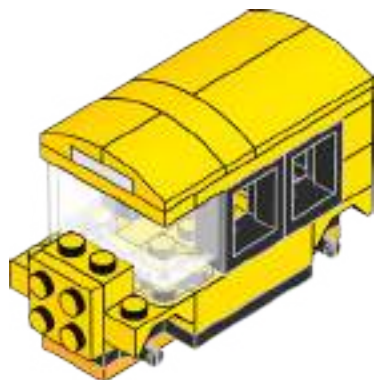

1x



2x

15





4x



4x

16



4x

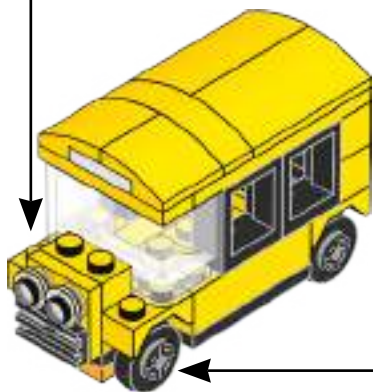

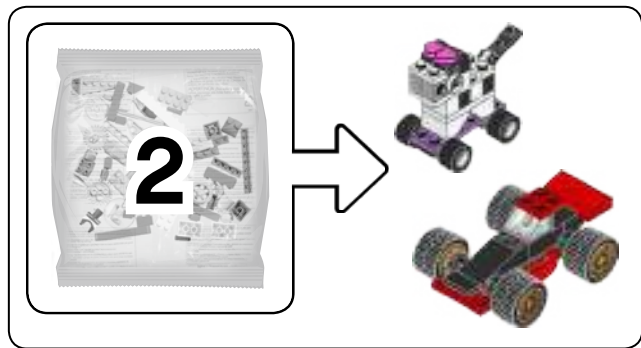

1



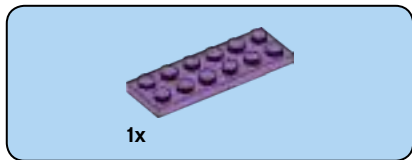

2



3





2x

4



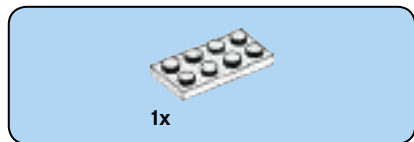

5

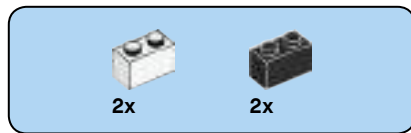

6



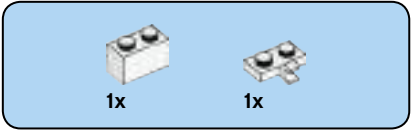

7

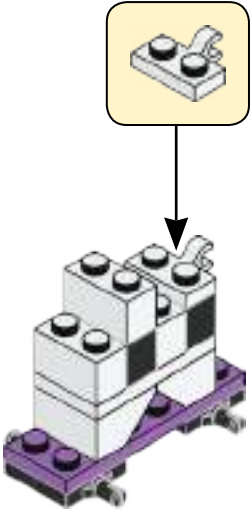

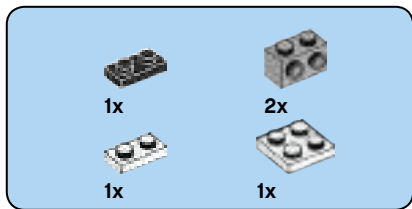

8

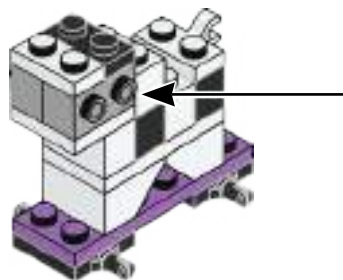
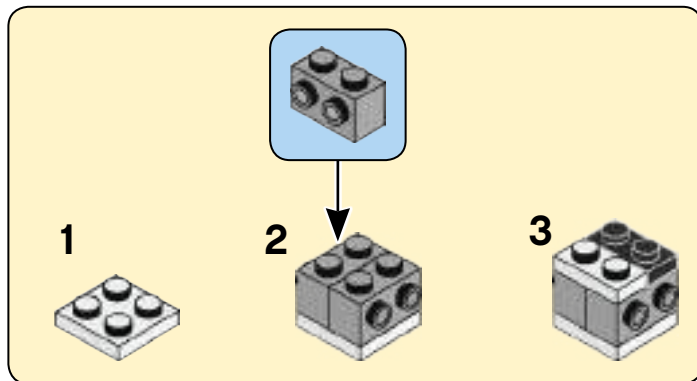



2x

9

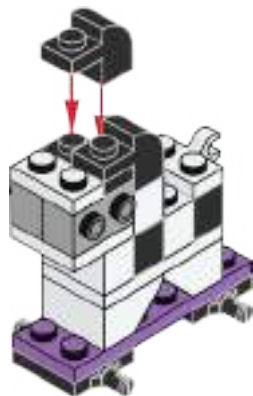



1x



2x

10



2x

11





12

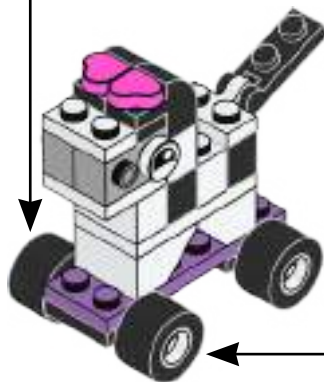
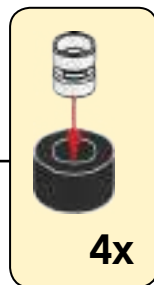

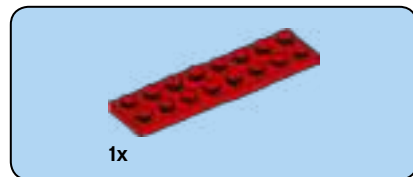

1



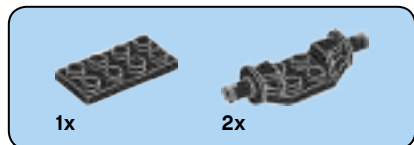

2

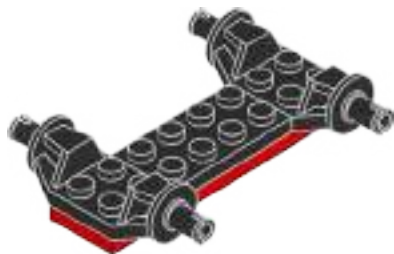



3

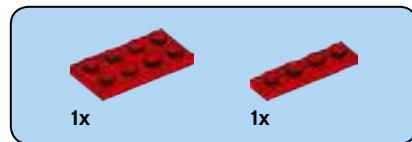

4



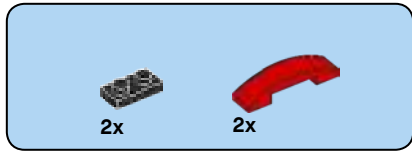

5

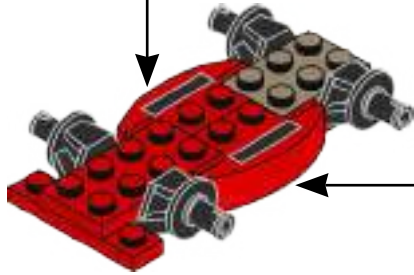
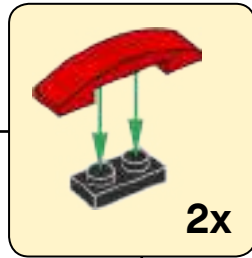



6

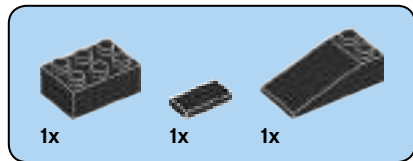

7

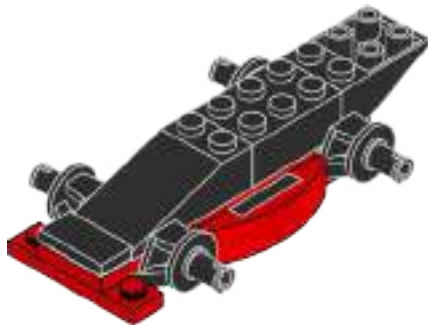



1x



1x

8

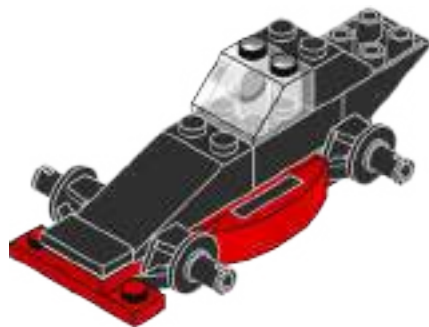

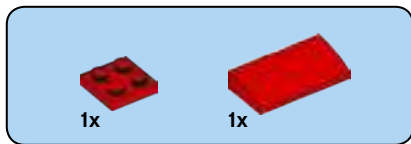

9



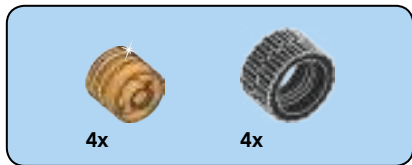

10

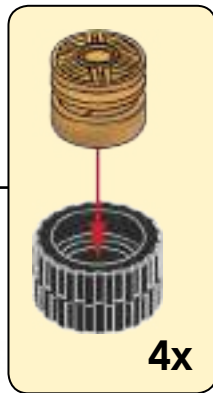
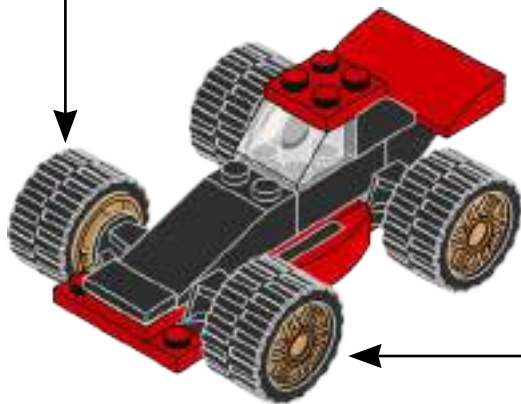

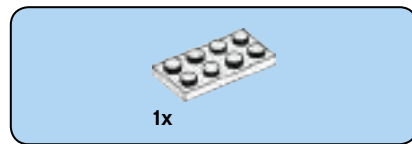
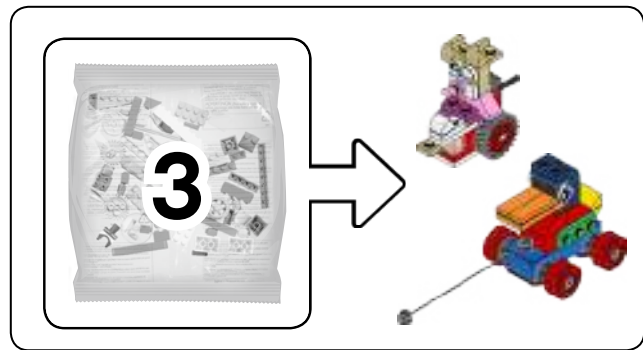

1





1x

2



1x

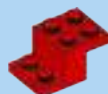

1x

3

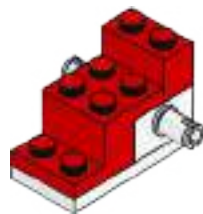



4

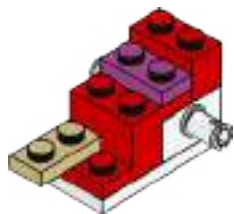

5

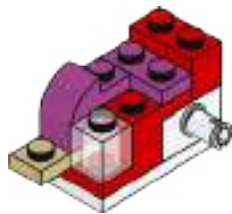



1x

6



1x



1x

7

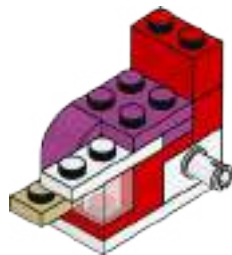



8

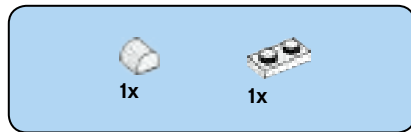
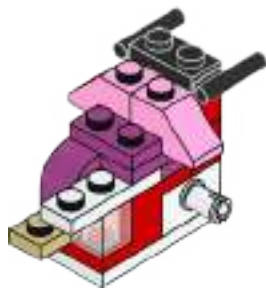

9

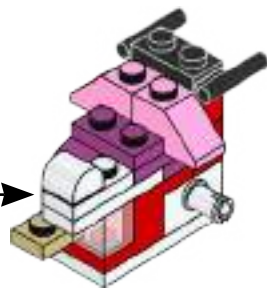
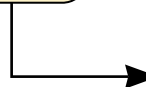
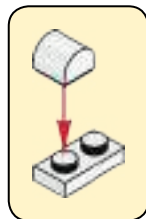

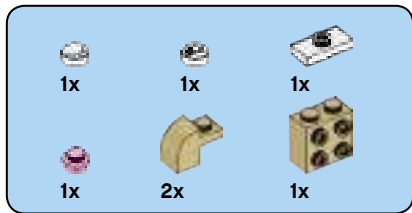

10

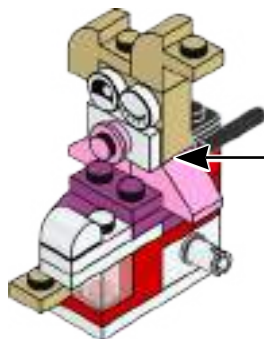
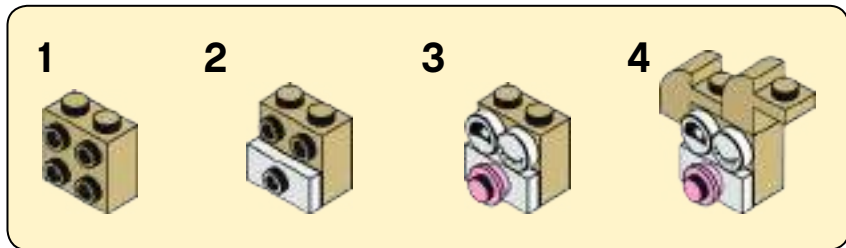

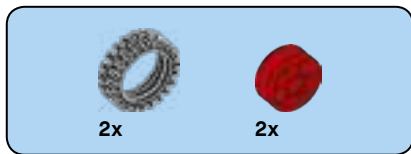

11

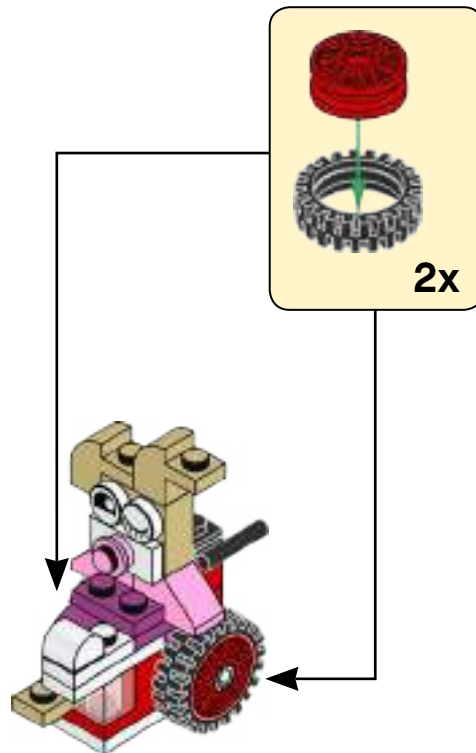

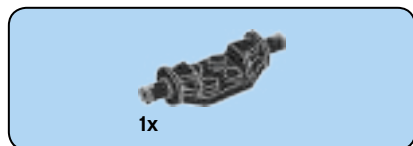

1



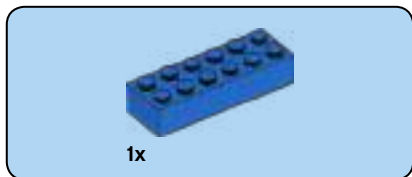

2





1x

3





4



5

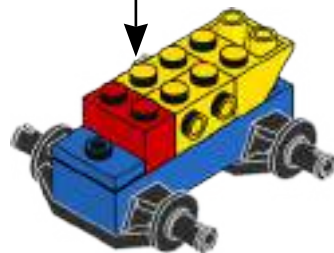



2x

6





7

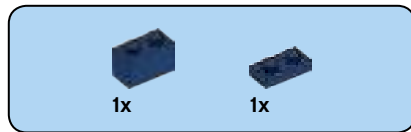
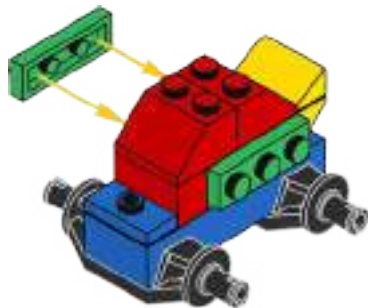

8



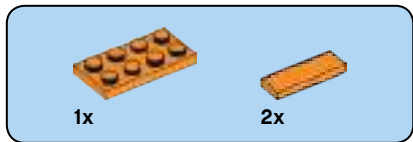

9

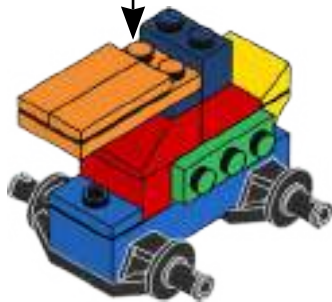
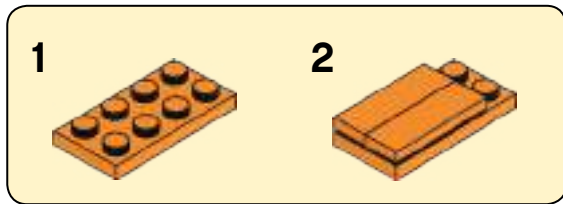



2x

10





2x

11

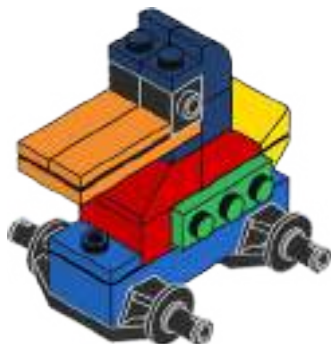

1x



2x

12

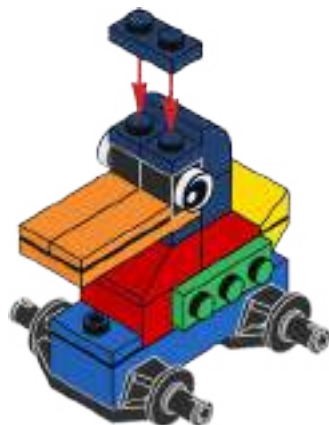

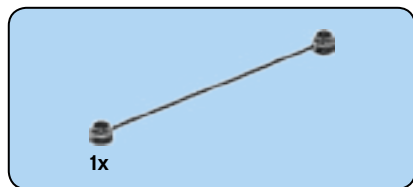

13

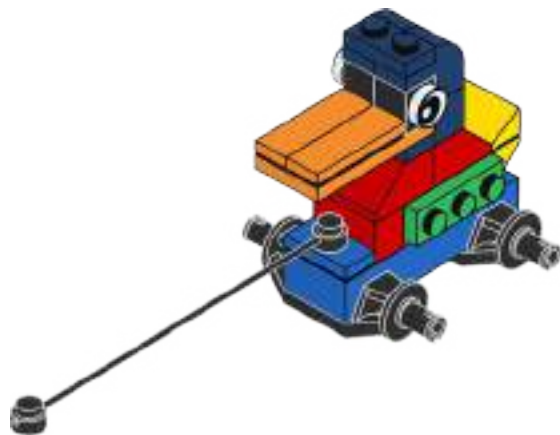



4x

14

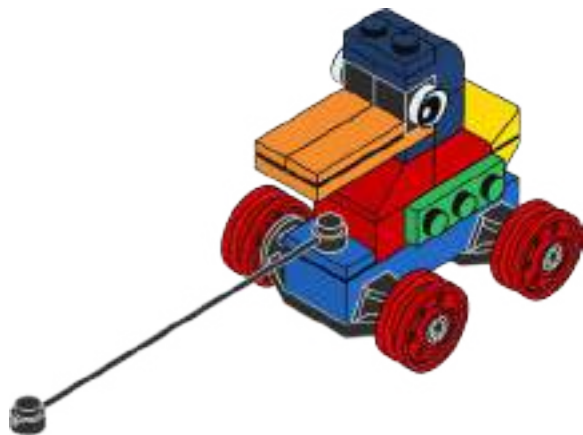



CLASSIC



What fun things can you build?
Welche lustigen Sachen kannst du bauen?
Quels objets amusants peux-tu construire ?
Quali cose divertenti sai costruire?
¿Qué cosas divertidas puedes construir?
Que coisas divertidas consegues construir?
Milyen mókás dolgokat tudsz megépíteni?
Kādas interesantas lietas tu uzbūvēsi?
你能拼搭出什么有趣的模型呢？





CLASSIC





1x
300226



1x
374726



1x
383926



2x
4660876



2x
302026



2x
4600178



1x
4185583



4x
4217725



1x
4243819



1x
303226



1x
303426

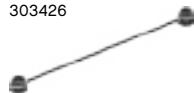

1x
6096955



1x
4529239



1x
6129807



2x
6117971



2x
4556159



2x
4565388



1x
300328



2x
4107758



2x
4107637



2x
621528



1x
371028



2x
4566179



2x
302028



2x
4106356

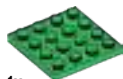

1x
4243821



2x
379528



2x
4220634



2x
4164037



2x
4650630



2x
4220632



1x
4617069



1x
4187743

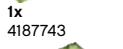

1x
4504850



2x
4537919



1x
6274738



4x
6240030



2x
6245250



1x
6220959



2x
6244904



1x
6239418



4x
6244886



1x
6253681



1x
6240532



2x
6208450



2x
6245252



1x
6244905



3x
6240212



2x
6244885



2x
6240214



2x
6245256



1x
6244907



1x
6244908



2x
6167615



2x
4620693



1x
4158355



1x
6240515



2x
6249422



1x
6244909

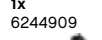

1x
6247359



2x
6254484



2x
6022035



1x
6109953



2x
6103415



3x
6109930



1x
6022048



1x
6035540



2x
4541506



1x
4177741



2x
4504374



1x
6253885

4x
4249891

4x
4528981

2x
6115447

1x
4296785

2x
6025375



2x
4530028



2x
4502089



2x
6275133



1x
6100239

60



2x
6101285



2x
4650244



2x
4245571



1x
6020923



2x
4586057

2x
6092035

2x
4622062

2x
6099730

1x
6327855

2x
6073042

2x
6131583

2x
6097503

1x
6331205

3x
6097511

3x
6100027

2x
6331526

2x
6020074

1x
6097509

1x
6133817

2x
4211242

1x
4221744

1x
6035291

1x
4660435

3x
6223599

2x
4223303

2x
4629736

2x
6335567

1x
6092590

2x
4211150

2x
4211199

2x
4211210

1x
6251470

2x
6338135

2x
4270882

8x
6194808

2x
6335378

4x
4621178

2x
4278273

2x
4211350

2x
6015344

4x
6044729

1x
4211568

2x
4211632

2x
6276848



2x
6265742



3x
6273227



2x
4211881



4x
6109684



1x
4221775



2x
6267142



2x
6063611



13x
4211504



2x
4211529

1x
6093054

1x
4211752

1x
4211395

1x
4243797

2x
4211392

1x
9566

1x
4296152

1x
6092582



























































2x
6345427

2x
4496366

2x
301023

2x
4181139

1x
303223

						
1x 4114584	4x 300524	1x 4613151	2x 6004938	1x 6270008	1x 4109995	1x 6214334
						
2x 6029947	2x 4624985		1x 6004943	2x 4211063	3x 4113917	
		2x 4597902				1x 6171006
1x 4550348	2x 4188357	2x 301024	1x 6307482	2x 4211111	2x 6069165	
		2x 301024				4x 6285616
2x 614324	2x 6336971	3x 300124	2x 6154879	1x 4502068	2x 4273526	
						5x 6284605
1x 371024	2x 6079007		3x 4655172	4x 6256130	2x 4579260	
						4x 307001
1x 302224	2x 287724	1x 303224	2x 4619512	8x 6310372	1x 4624086	
			2x 6136331	1x 4517996		1x 625401
2x 302024	3x 366024	2x 4523159	2x 6136331		1x 4666611	2x 614101
		2x 6284379		2x 4517995		
2x 4164073	2x 303924	2x 6284379	1x 4625027		3x 4114084	8x 6011380
				1x 6102999		1x 6258135
2x 6303233	3x 6119197	4x 6109685	2x 4211094	2x 6002148	1x 4114001	



2x
6174937



4x
366001



2x
300301



2x
362301



2x
6186675



10x
4578677



2x
6122656



2x
4535737



1x
6089696



1x
6035762



2x
395701



3x
302326



2x
6184784



6x
460026



2x
393701



1x
6284604



1x
302101



2x
302001



4x
307026



2x
4558954



1x
6052126



1x
6051511



6x
6284599



2x
6126046



2x
4143000



1x
306926



2x
4548180



2x
3003126



4x
302301



2x
306201



2x
6126046



2x
4143000



1x
303926



1x
4107761



2x
6093525



2x
6285777



1x
6313115



1x
306801



3x
300101



4x
4246901



1x
4140588



2x
4565323



1x
302201



7x
300401



2x
6146215



1x
4181142



2x
6168646



6x
4516843



2x
4541191



2x
370001



4x
4160228



1x
4520970



1x
303401



10x
4295370



8x
6132299



1x
241226



3x
4515368



2x
366026



1x
400626



8x
4508215



10x
4541455



5x
4521439



2x
300326



2x
300426



1x
4597912



1x
371021



2x
303721



2x
300121



2x
302021



1x
303221



2x
303421



1x
6132541



2x
4278275



1x
4521852



2x
6168619



2x
301021



1x
6019155



1x
6172642



2x
4633914



1x
74335



2x
306221



1x
9552



2x
6072998



4x
300521



2x
6284574



1x
6066342



1x
302221



2x
6275178



2x
6117974



6x
6048859



3x
300421



2x
303921



5x
4612575



1x
4226876



2x
4600176



2x
302321



1x
4651524



2x
6268946



Customer Service

Kundenservice

Service Consommateurs

Servicio Al Consumidor

LEGO.com/service or dial



: 00800 5346 5555

: 1-800-422-5346



WIN

GO TO WWW.LEGO.COM/PRODUCTFEEDBACK AND
GIVE US YOUR SHORT **FEEDBACK** ABOUT THIS
LEGO® SET FOR A CHANCE TO WIN
A COOL LEGO PRIZE.

Terms & Conditions apply

LEGO.com/productfeedback

GEWINNE

Erzähle uns auf
www.LEGO.com/productfeedback

etwas über die Erfahrungen, die du mit
diesem LEGO® Set gemacht hast, und
sichere dir die Chance auf einen coolen
LEGO Preis!

Es gelten die Teilnahmebedingungen

GAGNE

Rends-toi sur
www.LEGO.com/productfeedback

et donne-nous quelques commentaires sur
ce produit LEGO® pour avoir une chance
de gagner un prix LEGO !

Voir Conditions Générales

GANAN

Visita
www.LEGO.com/productfeedback

y envíanos tu opinión acerca de este set
LEGO®. ¡Participarás en el sorteo de un
premio LEGO!

Términos y Condiciones aplicables

获取奖品

登录
www.LEGO.com/productfeedback

给出关于此乐高®套装的简短反馈，
就有机会获得炫酷乐高高奖品

《条款及条件》适用

LEGO and the LEGO logo are trademarks of the LEGO Group. ©2021 The LEGO Group.

6349721