



We're switching from plastic to paper-based packaging. That's why you might find a mix of paper and plastic in our boxes!

Wir stellen von Kunststoffverpackungen auf Verpackungen auf Papierbasis um. Möglicherweise findest du deshalb sowohl Papier als auch Kunststoff in unseren Boxen!

Nous abandonnons progressivement les emballages en plastique au profit d'emballages à base de papier. Il est donc possible que vous trouviez à la fois du papier et du plastique dans nos boîtes !

Stiamo passando dagli imballaggi di plastica a quelli basati su carta. Ecco perché potreste trovare un mix di carta e di plastica nelle nostre confezioni!

Estamos sustituyendo las bolsas de plástico por bolsas con base de papel. ¡Por eso, puede que encuentres una mezcla de papel y de plástico en nuestras cajas!

Estamos a substituir as nossas embalagens de plástico por embalagens à base de papel. Por isso poderá encontrar um misto de papel e plástico nas nossas caixas!

Átállunk a műanyagról a papír alapú csomagolásra. Ezért előfordulhat, hogy a dobozainkban papír és műanyag zacskót egyaránt találasz!

Mēs pārejam no plastmasas iepakojuma uz iepakojumu, kurā izmantots papīrs. Tāpēc mūsu kārbās var būt gan papīra, gan plastmasas daļas.

Trecem de la ambalajele din material plastic la ambalaje pe bază de hârtie. Iată de ce s-ar putea să găsești un amestec de hârtie și material plastic în cutiile noastre!

我们正在从塑料包装向纸基包装过渡。这就是为什么你可能会发现我们的包装盒中同时出现塑料和纸质材料！

[LEGO.com/sustainable-packaging](https://www.lego.com/sustainable-packaging)



乐高® 拼搭指引

Check for compatibility
 Kompatibilität prüfen
 Vérifier la compatibilité
 Controlla la compatibilità
 Comprueba tu compatibilidad
 Verificar a compatibilitade
 Ellenőrizd a kompatibilitást
 Pārbaudīt saderību
 Verificarea compatibilității
 检查兼容性

[LEGO.com/devicecheck](https://www.lego.com/devicecheck)



LEGO® Building Instructions



Apple and the Apple logo are trademarks of Apple Inc.
 Google Play and the Google Play logo are trademarks of Google LLC.
 Tencent and the Tencent logo are trademarks of Tencent Inc.

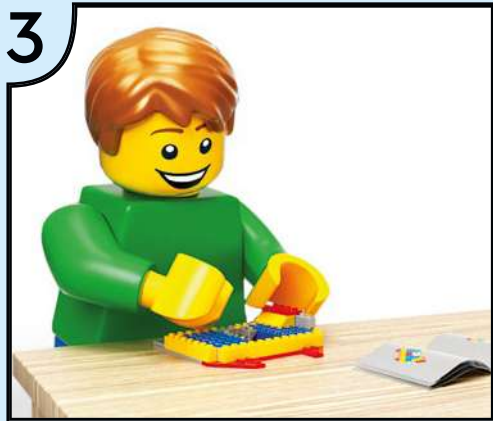



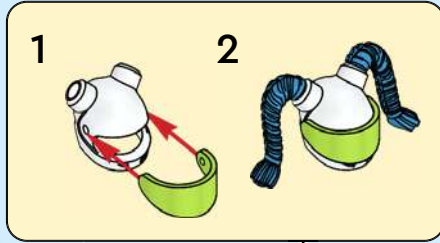
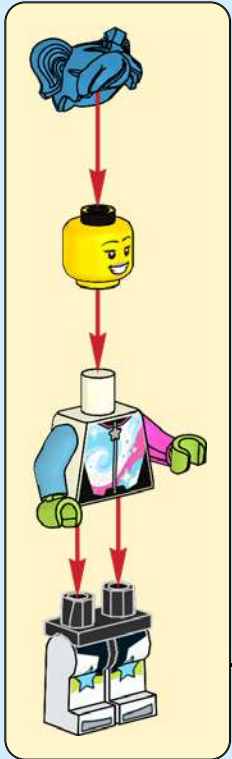

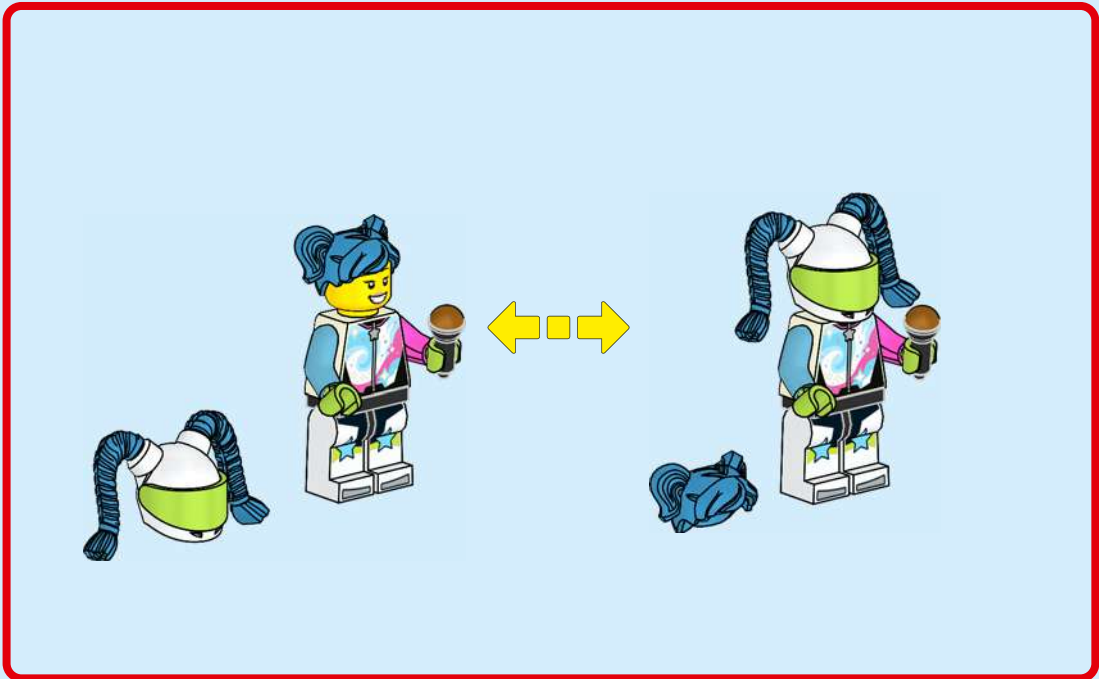

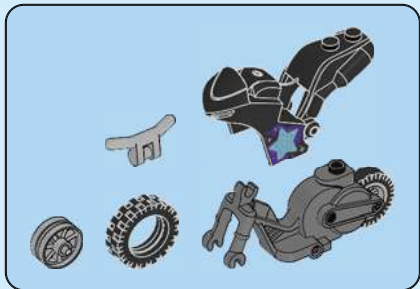

1

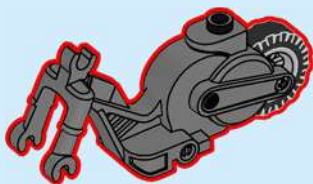

2

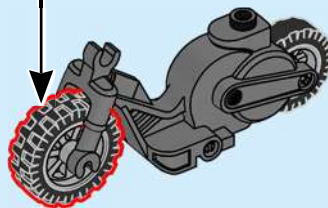

3

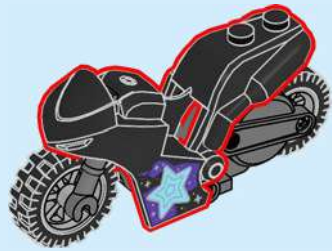

4





1



2



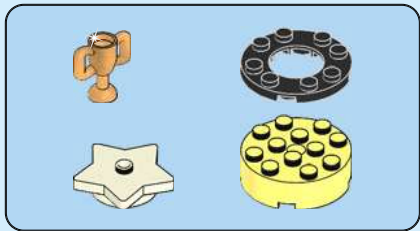

1

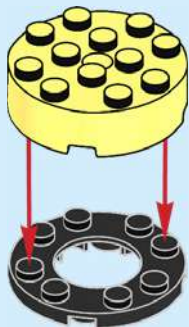

2

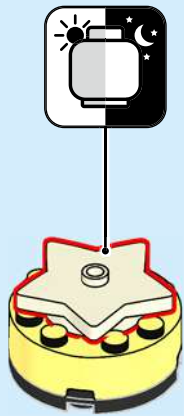

3



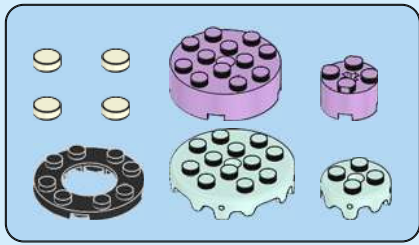

1

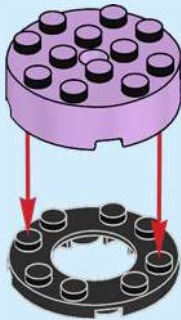

2



3

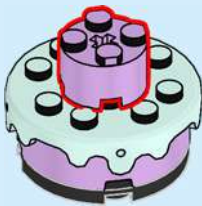

4



5

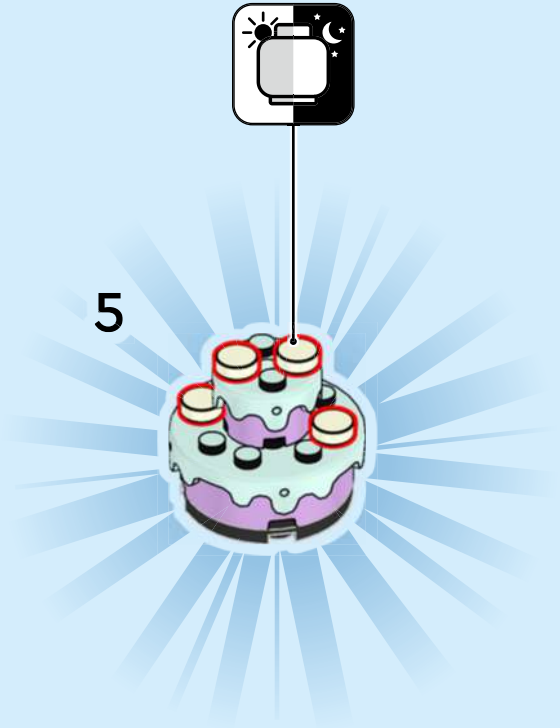

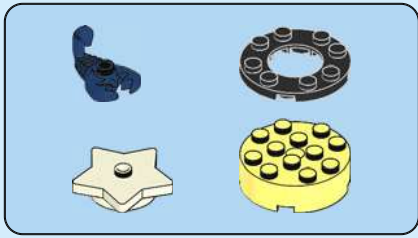

1

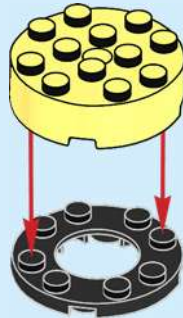

2

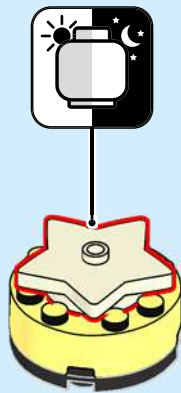

3



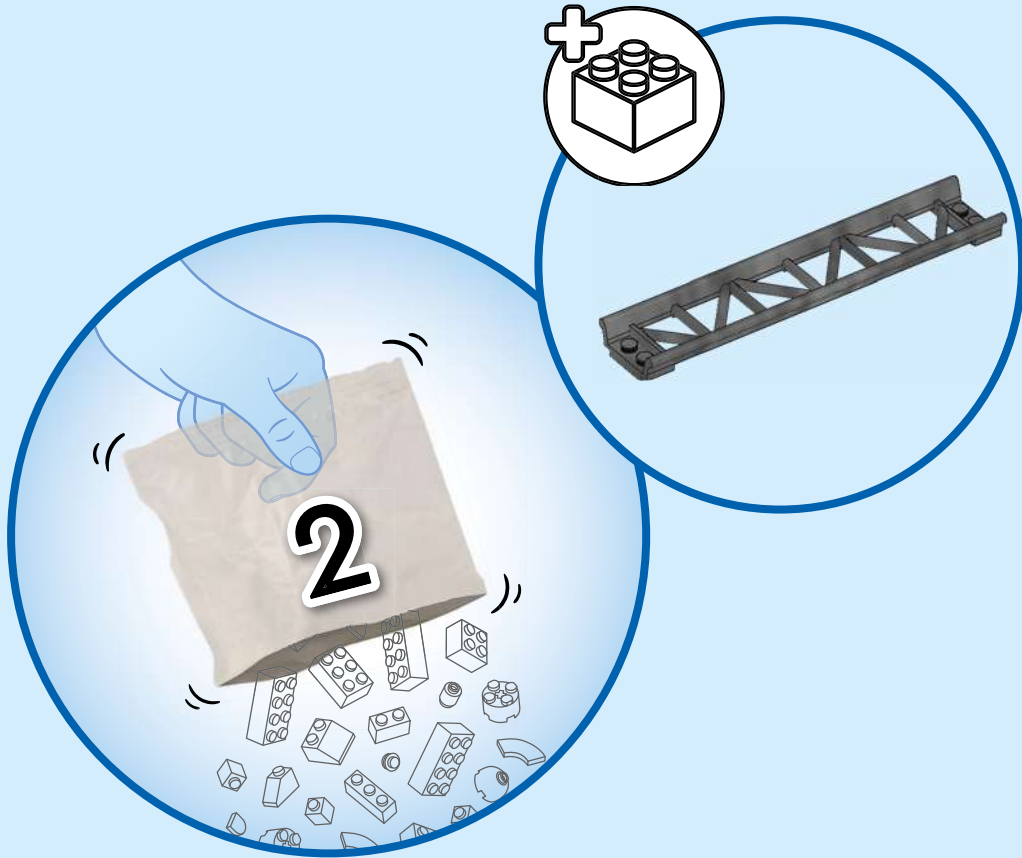

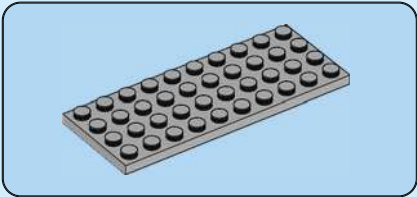
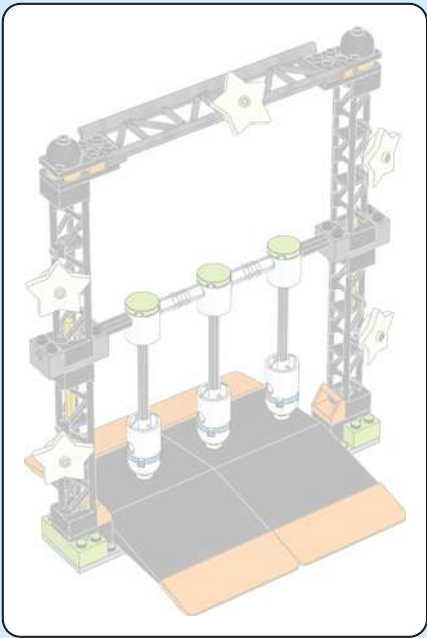

1

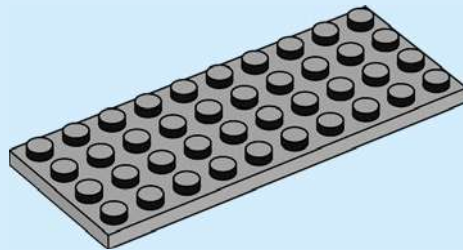

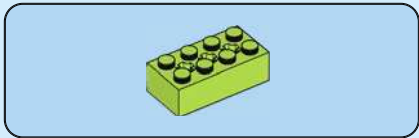

2

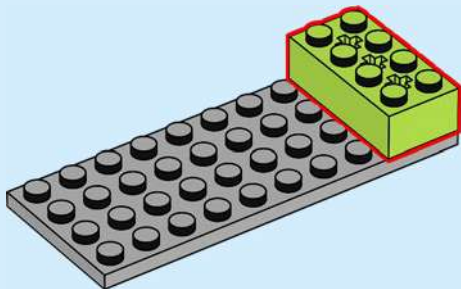

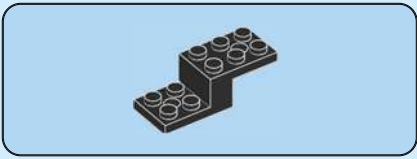

3

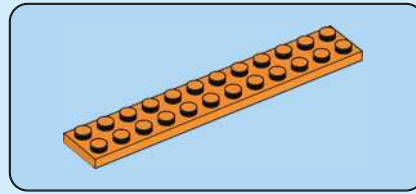
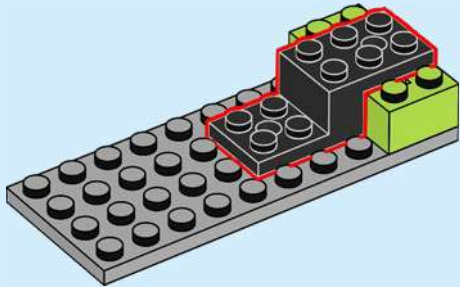

4

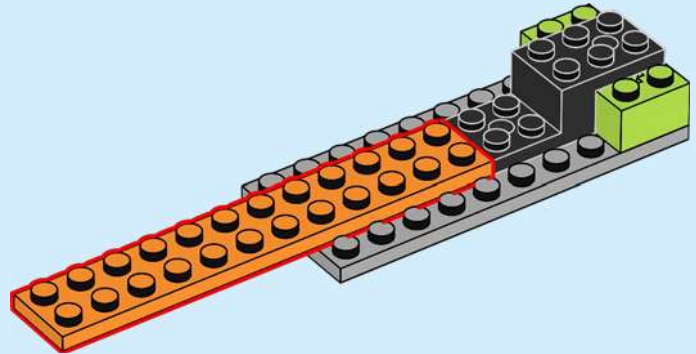



5

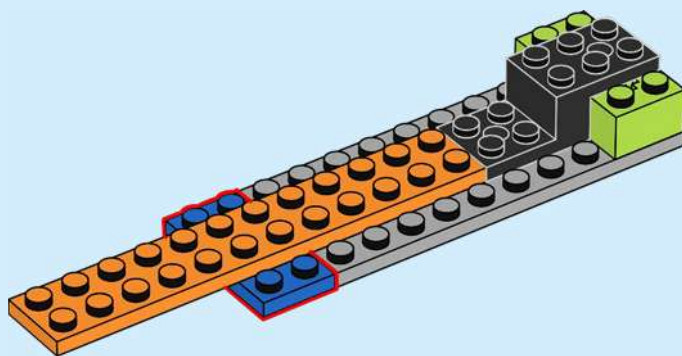

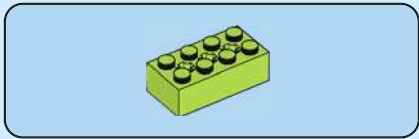

7

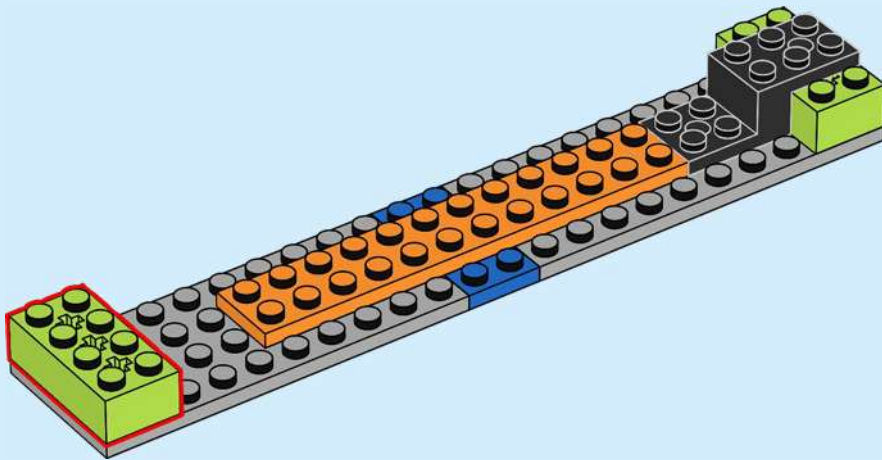

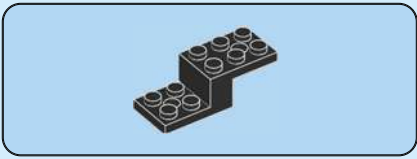

8

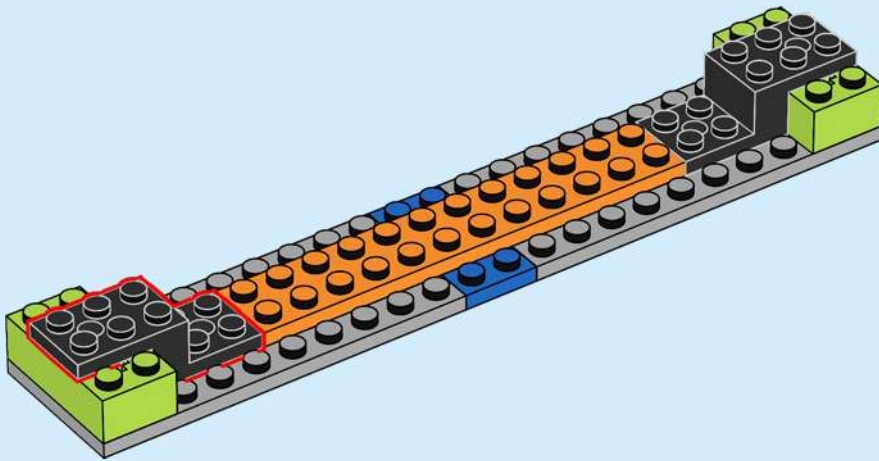

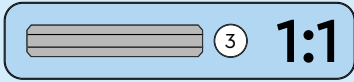
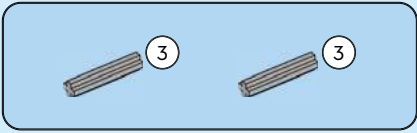

9

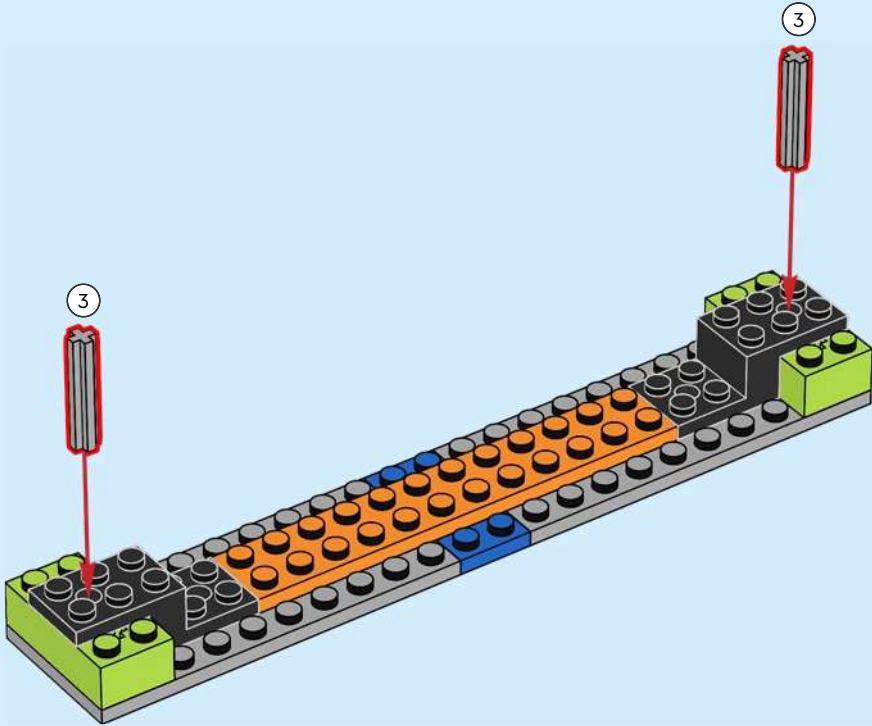

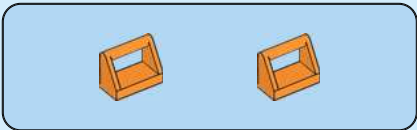

10

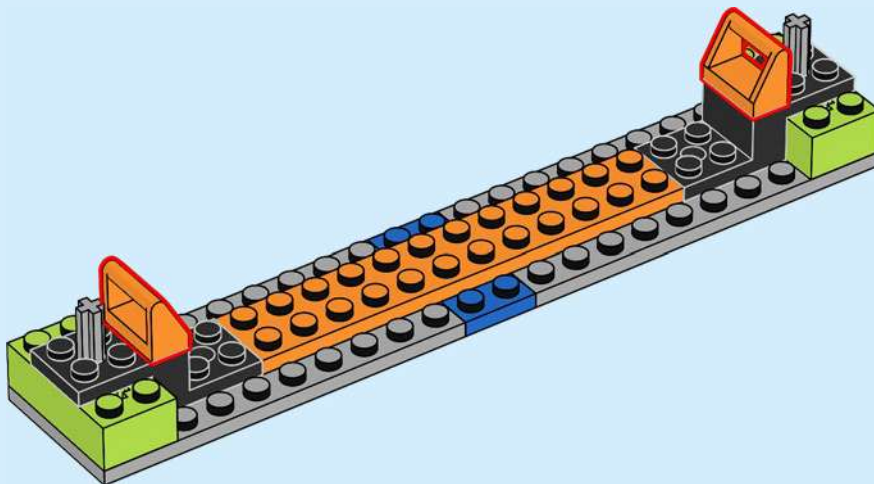

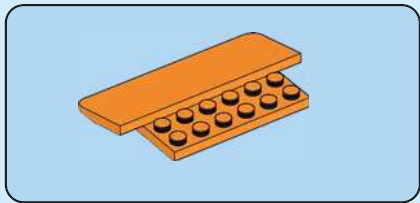
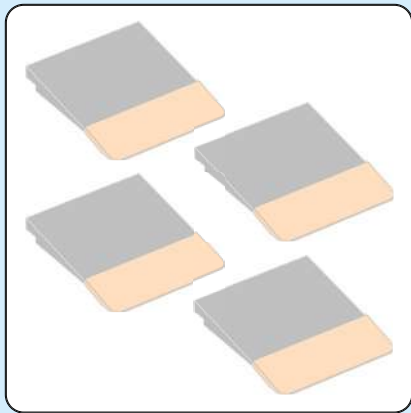

11

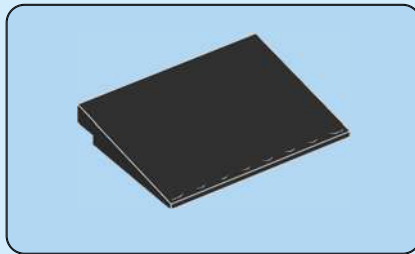
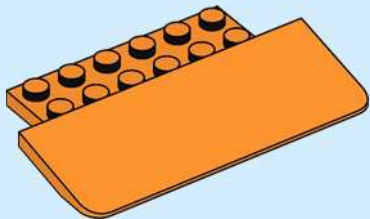

12

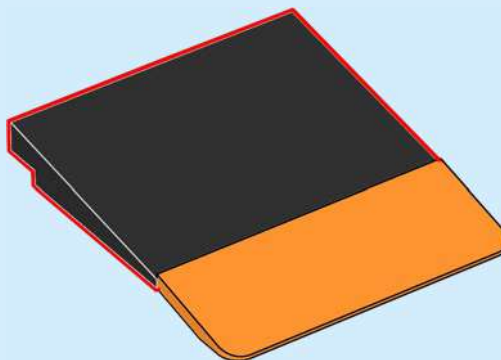

4x

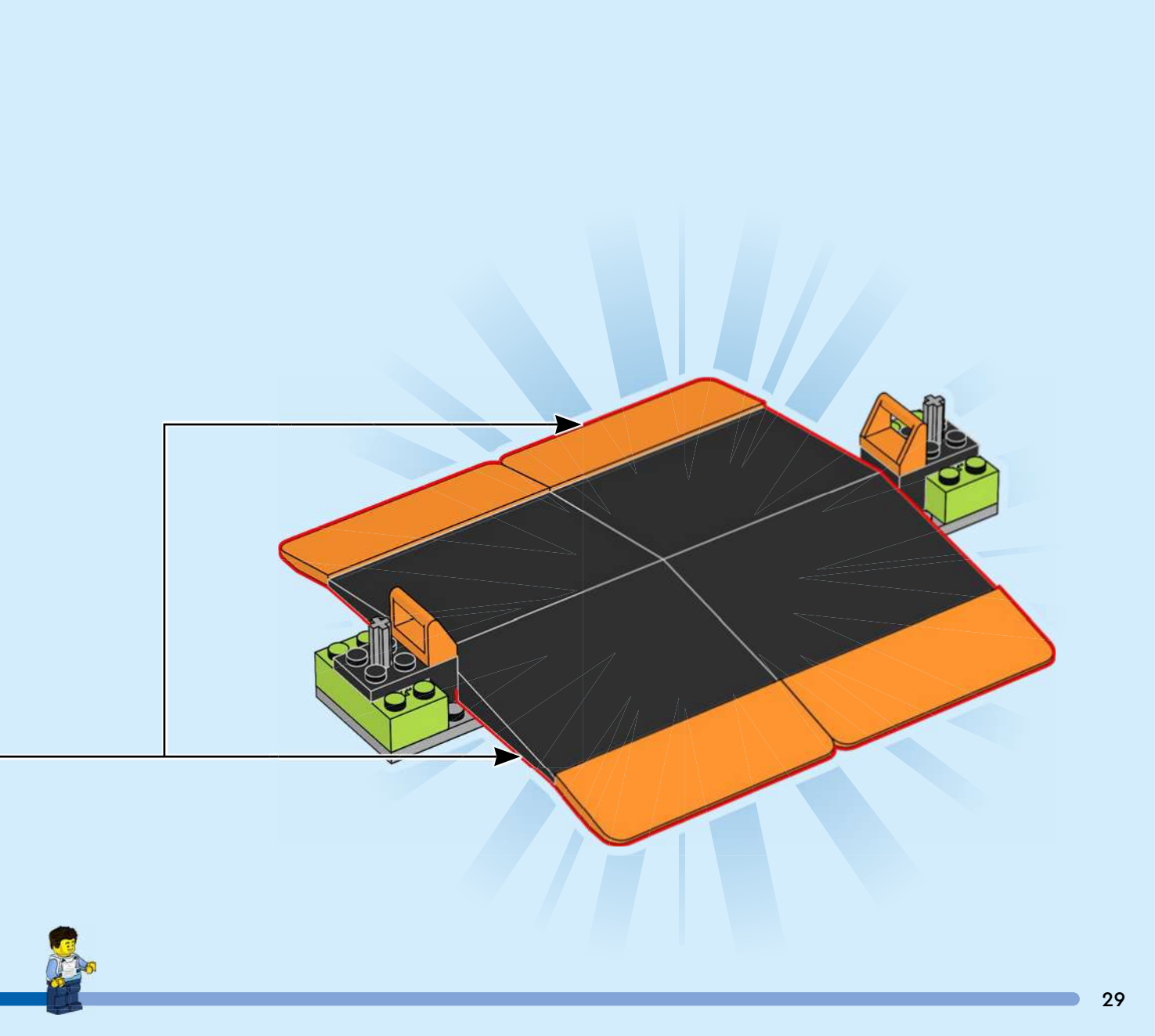

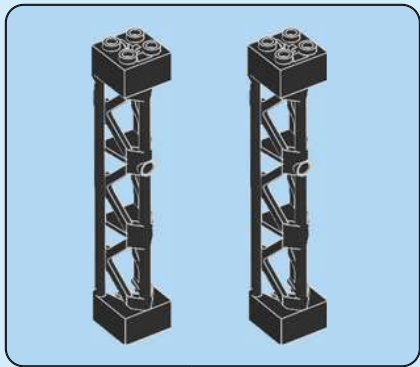

13

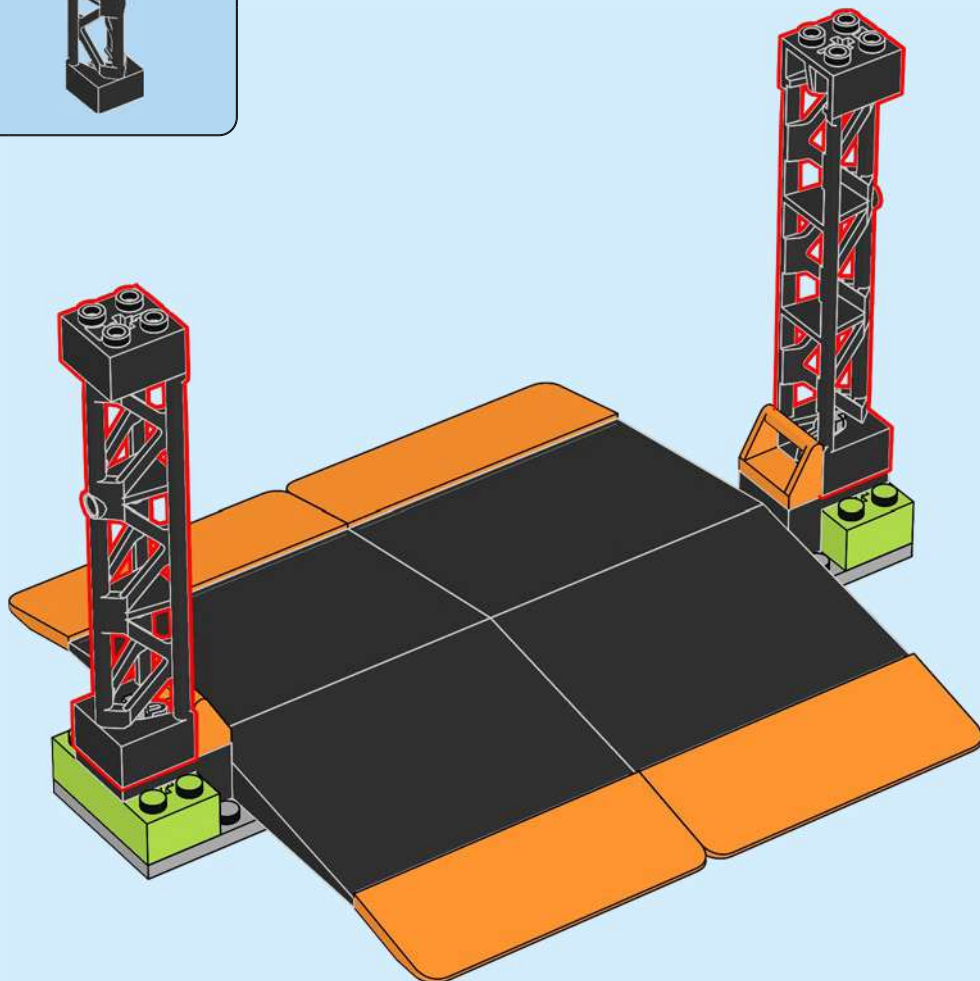

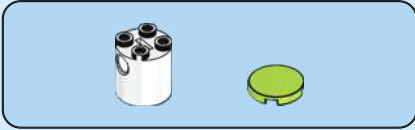
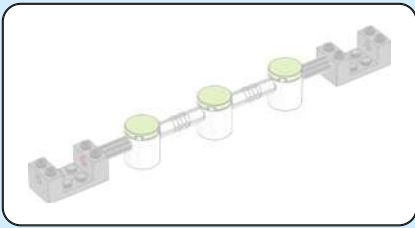

14

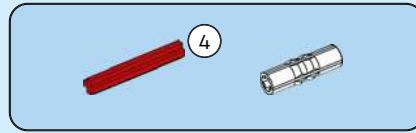

15

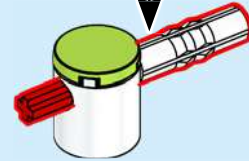
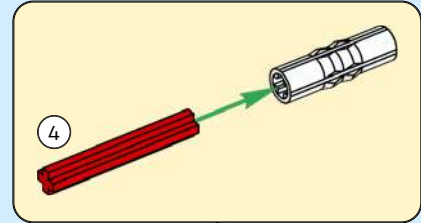



16

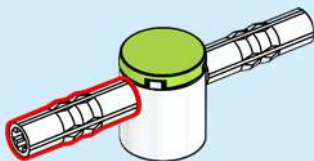

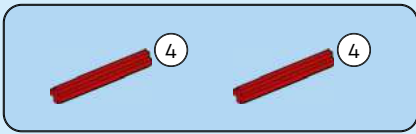

17

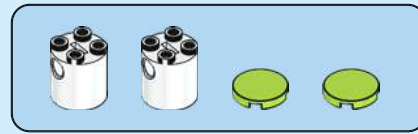
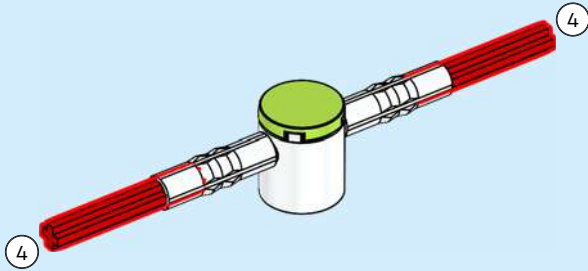

18

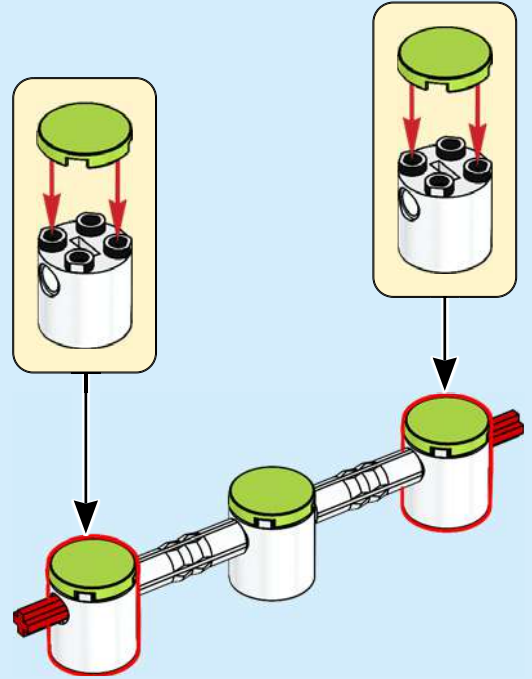

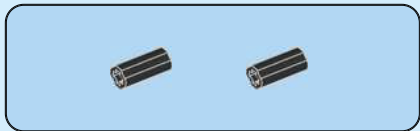

19

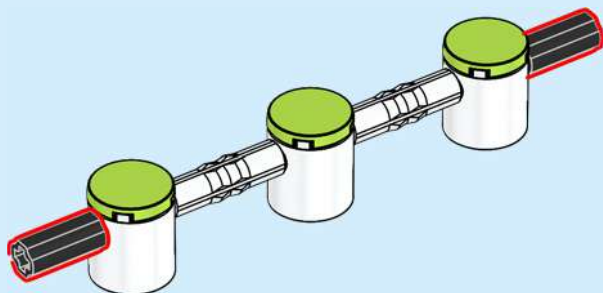

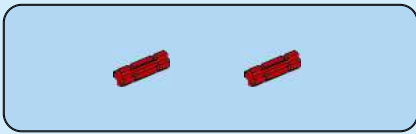

20

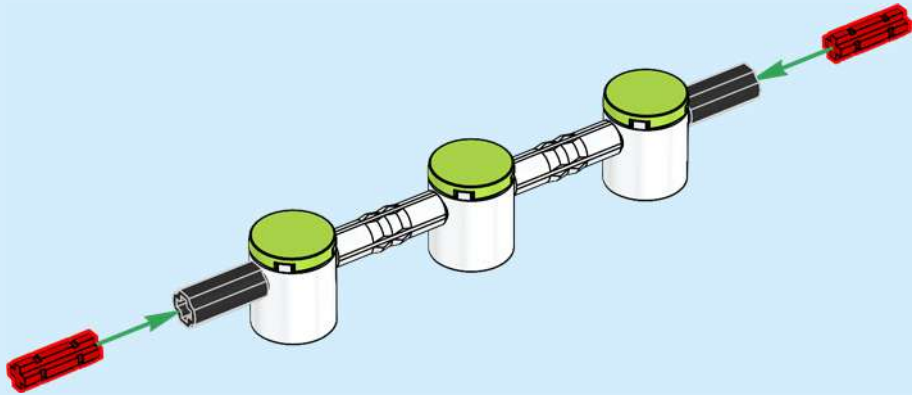

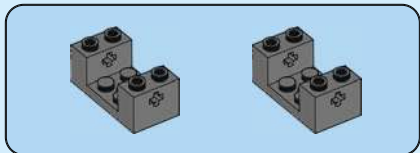

21

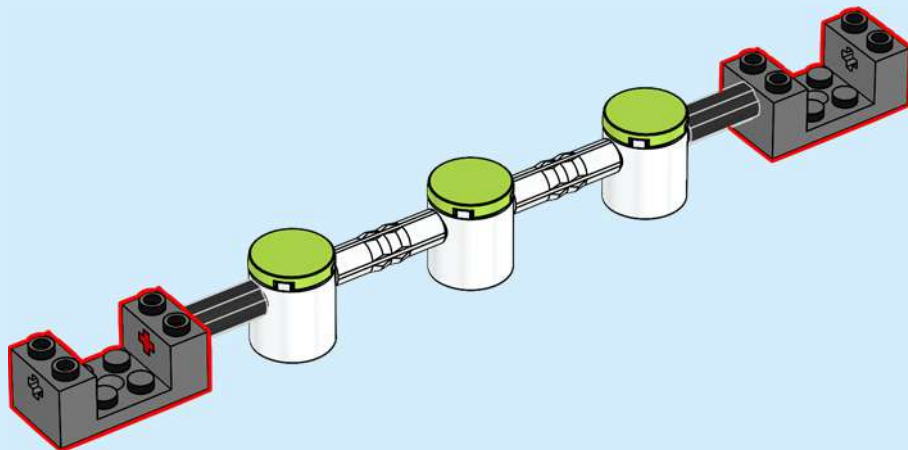

22

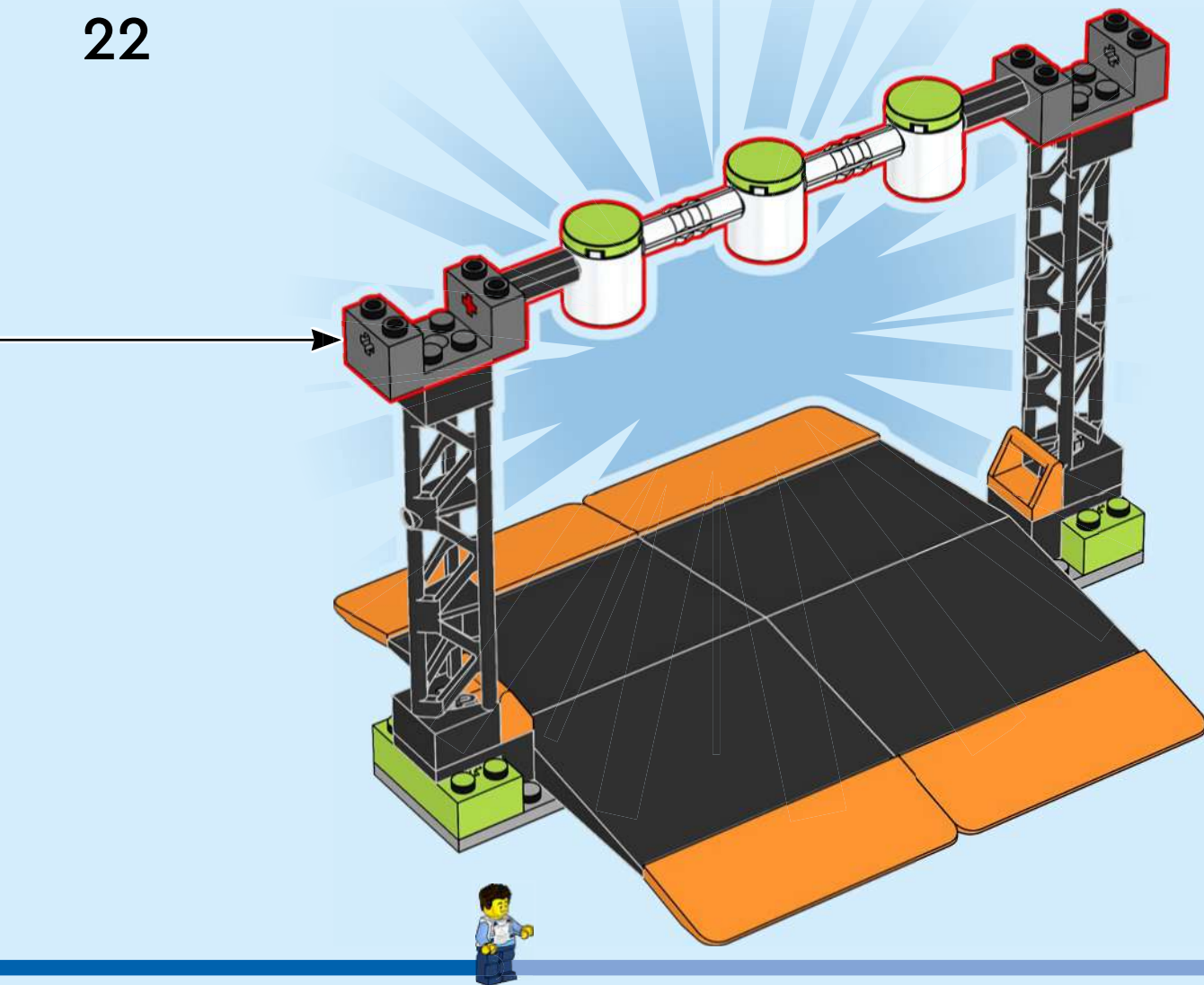

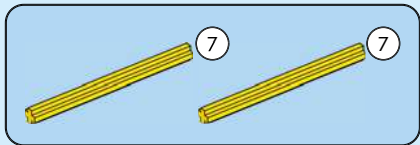

23

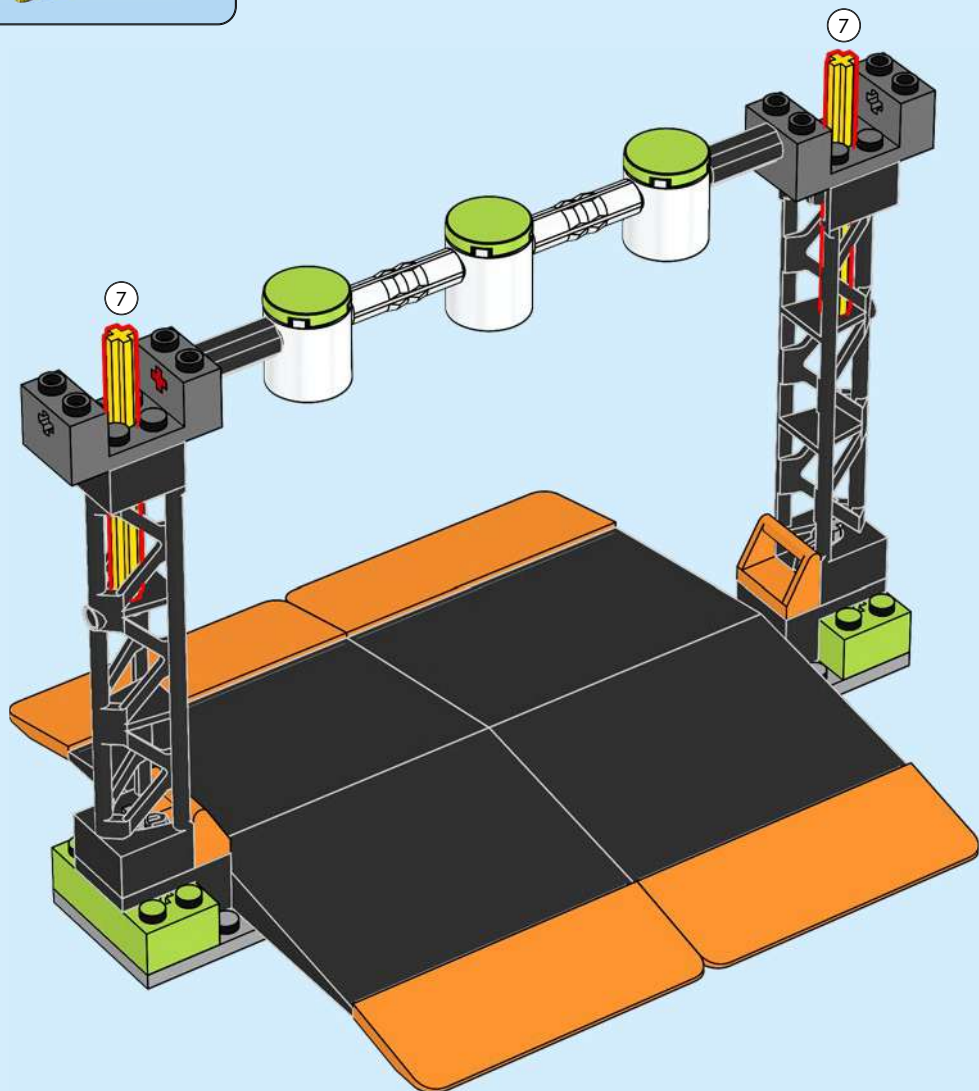



24

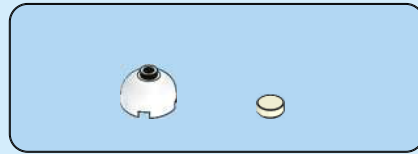

25



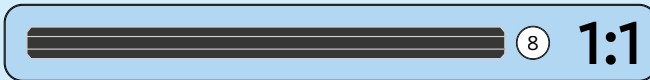
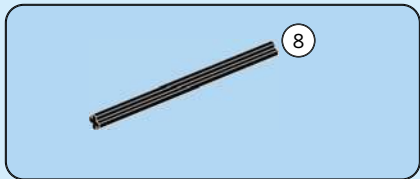

26

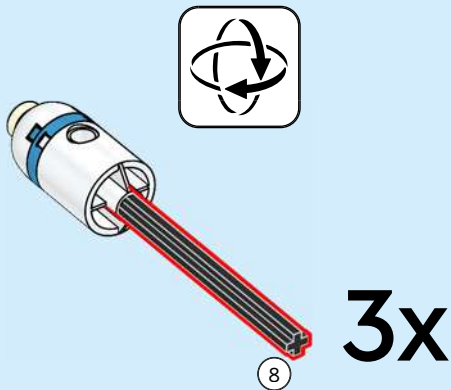

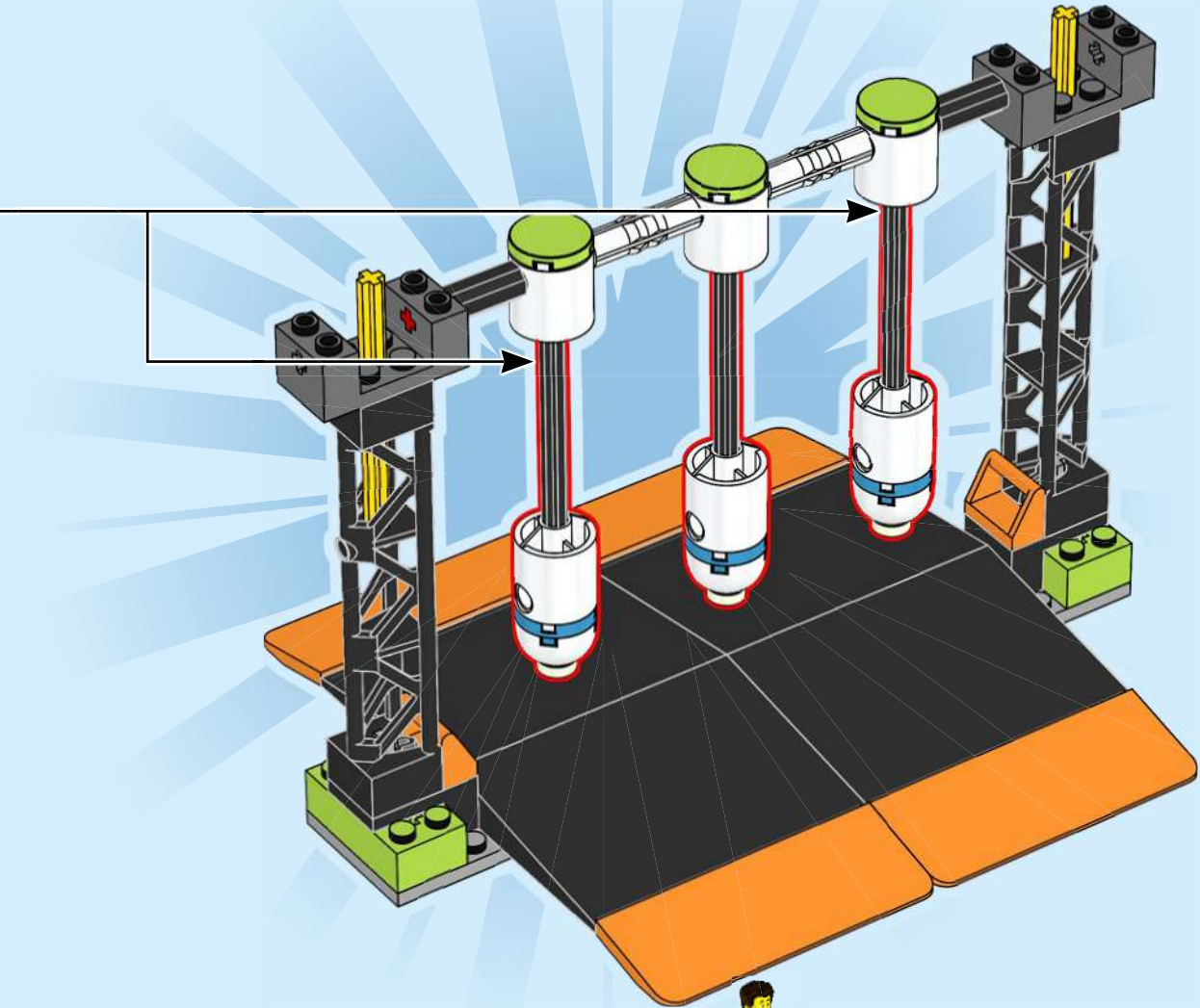

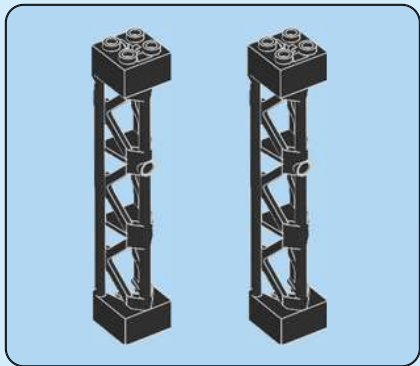

27

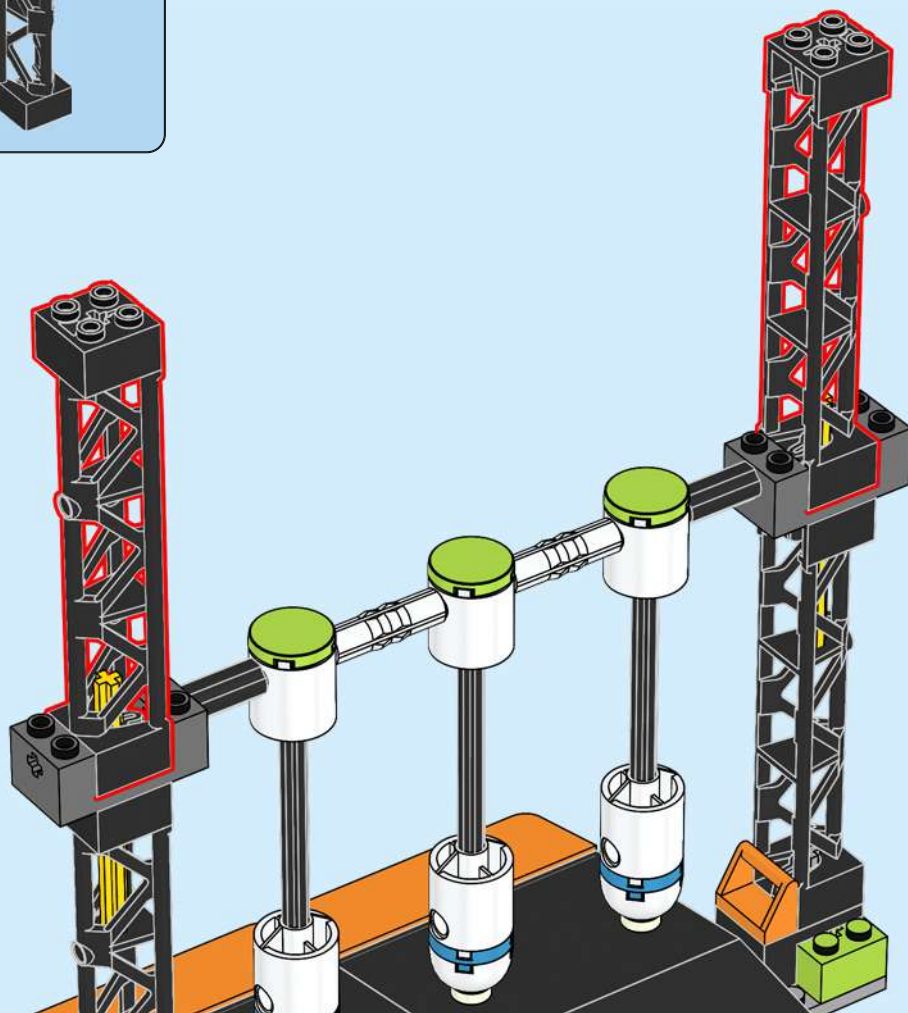



28

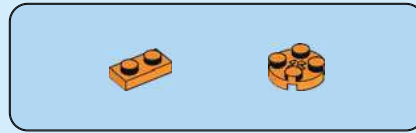
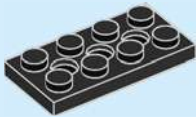

29



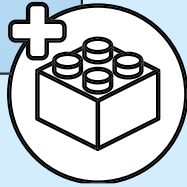
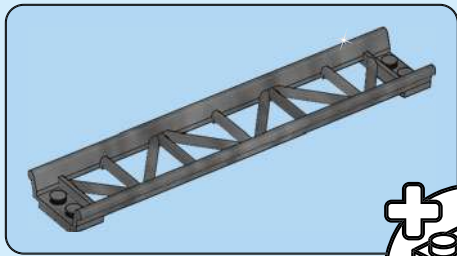

30

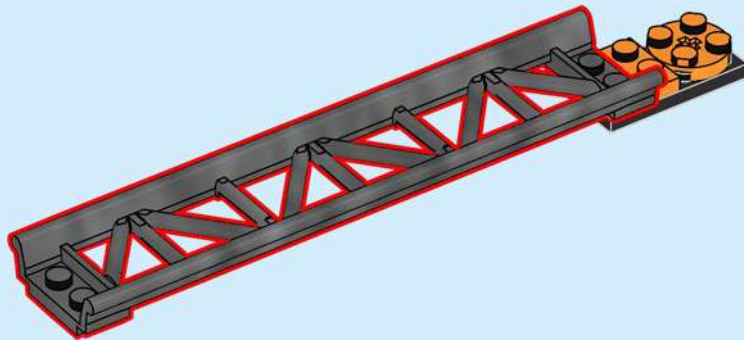



31

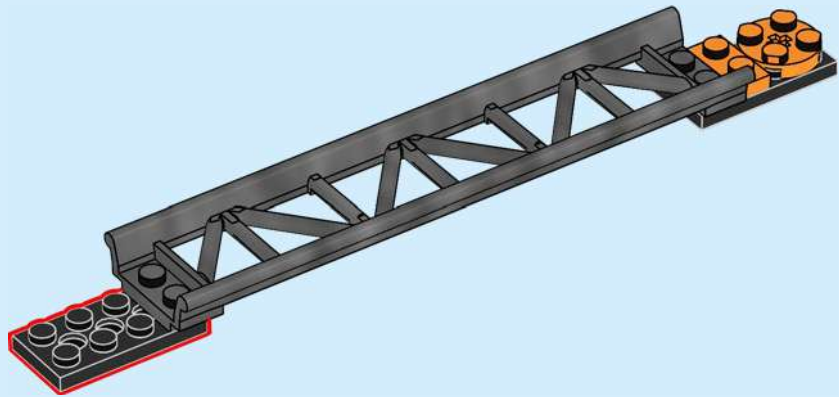

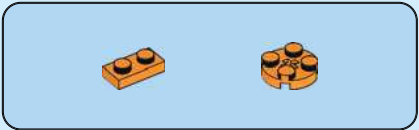

32

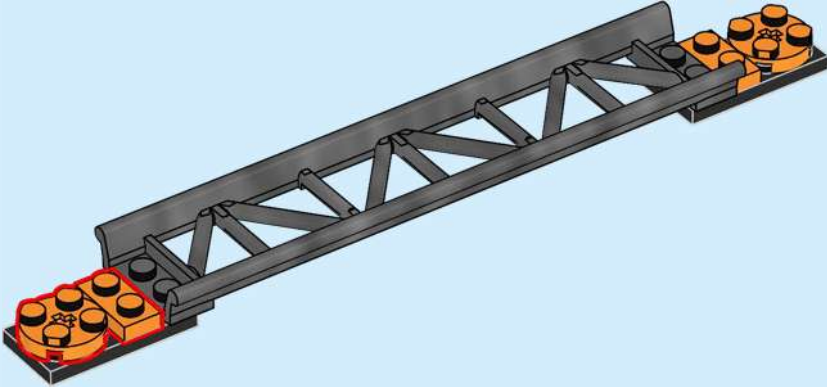



33

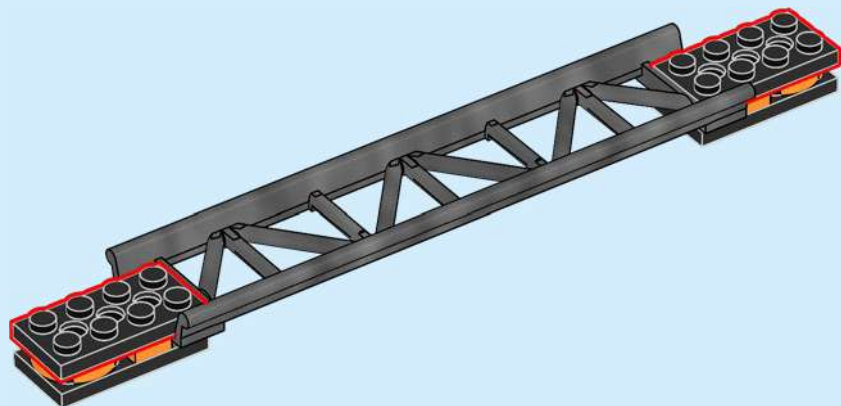

34

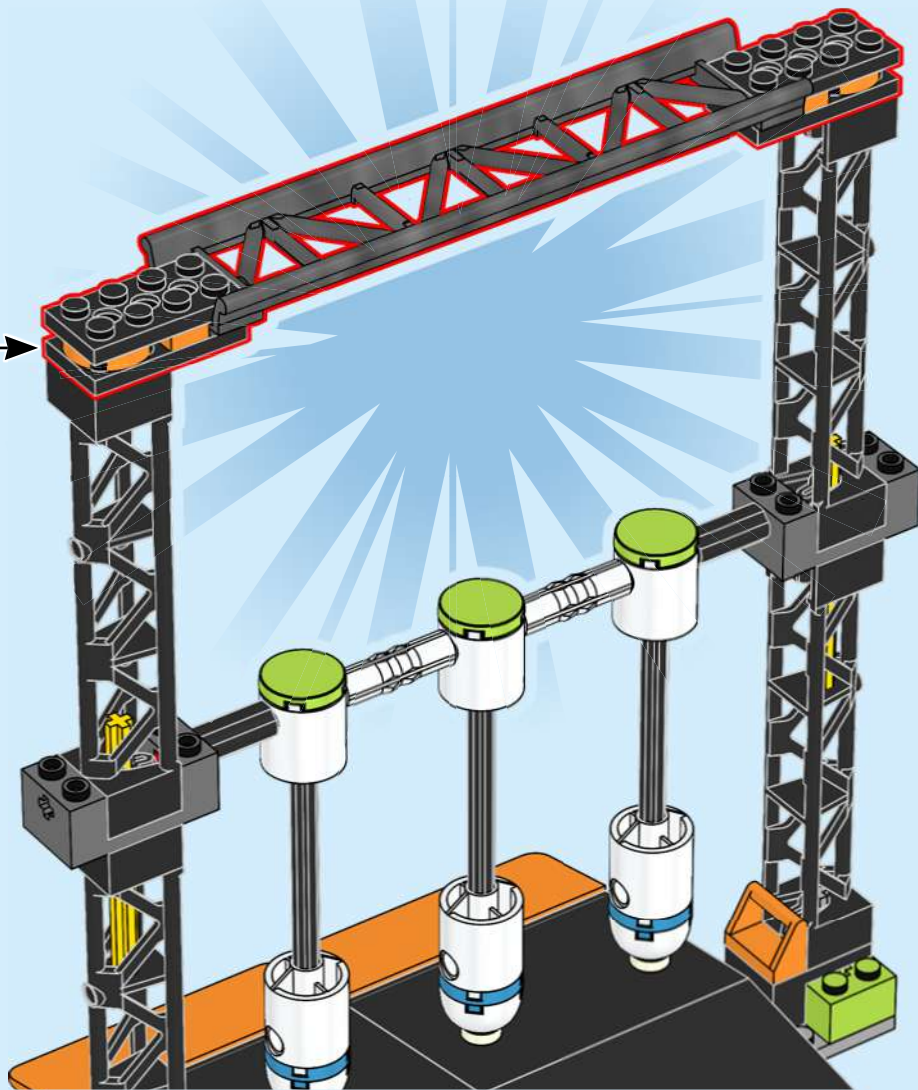

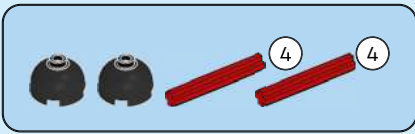

35

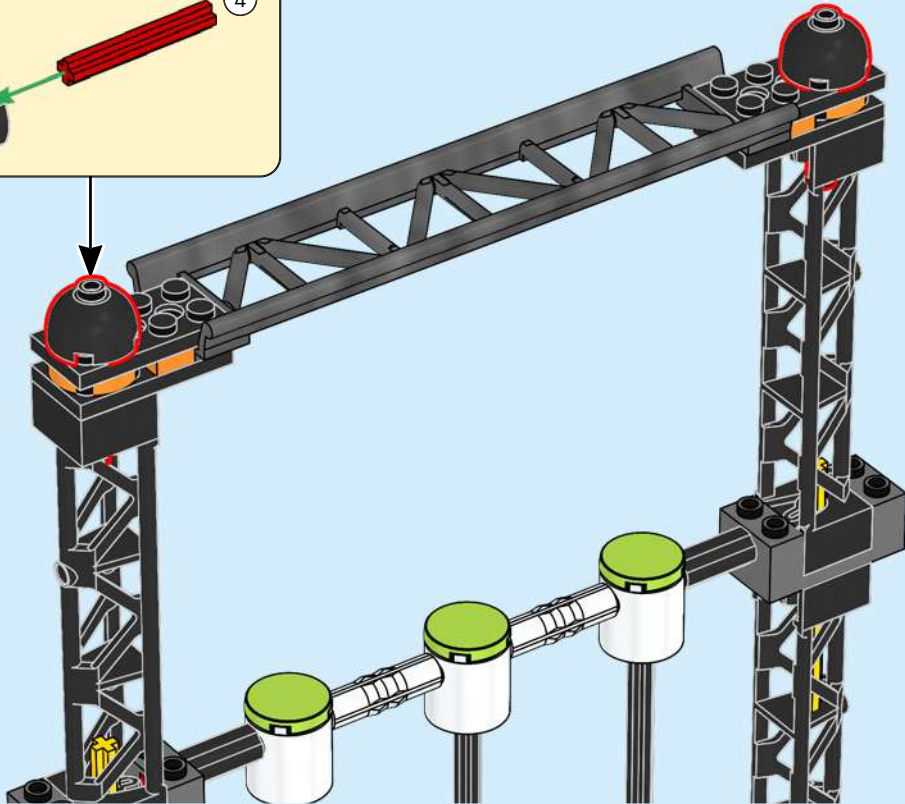
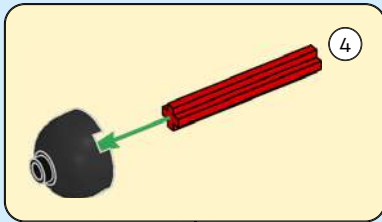
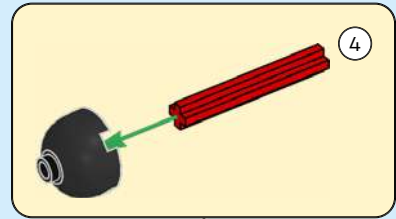

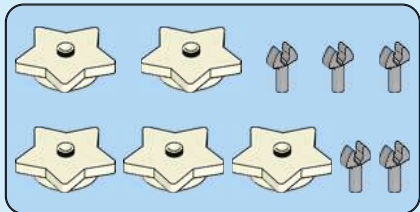
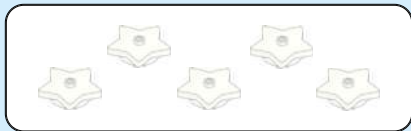

36

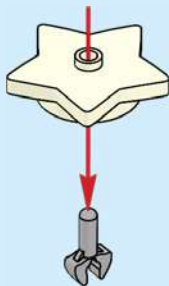

5x

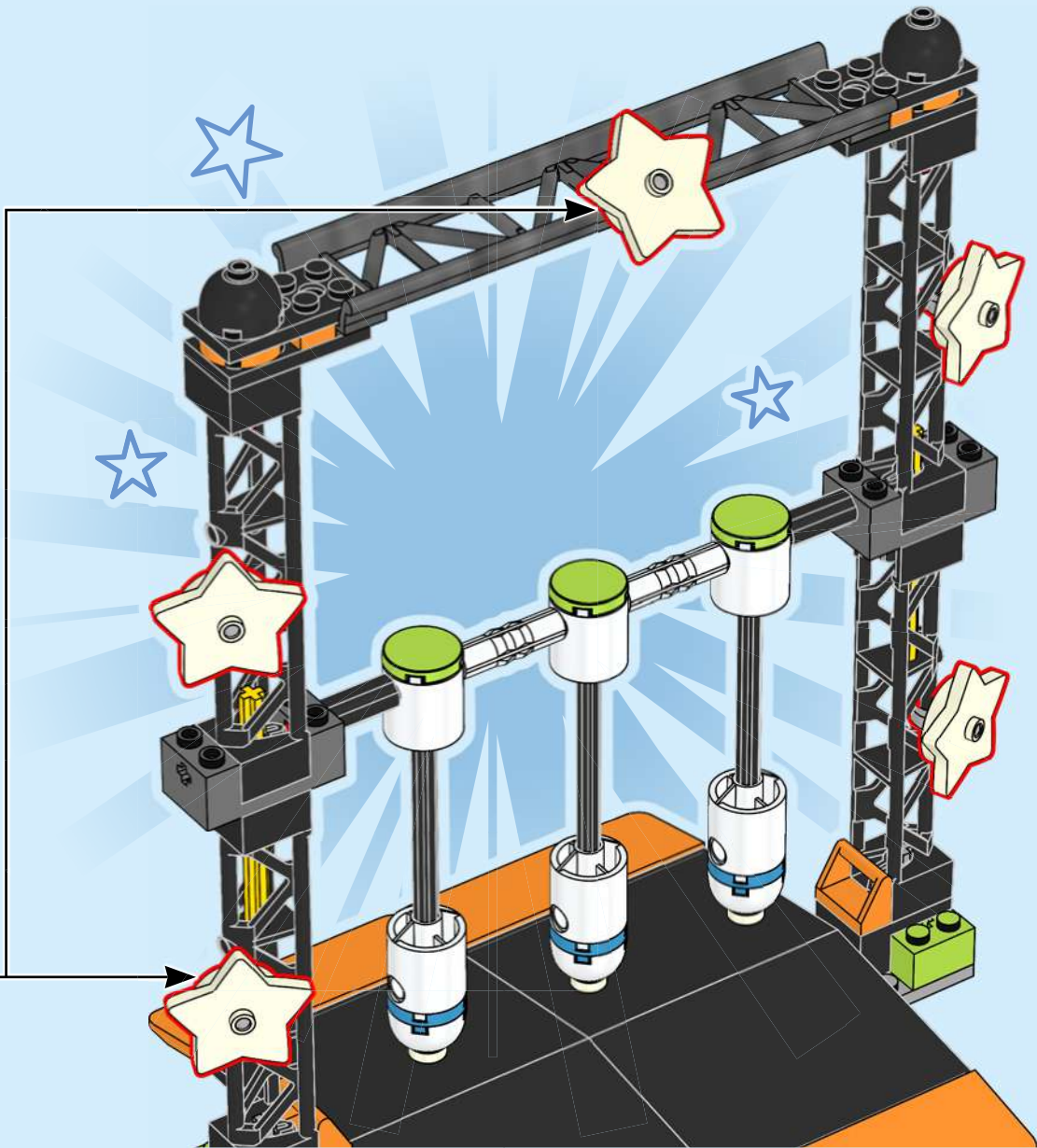

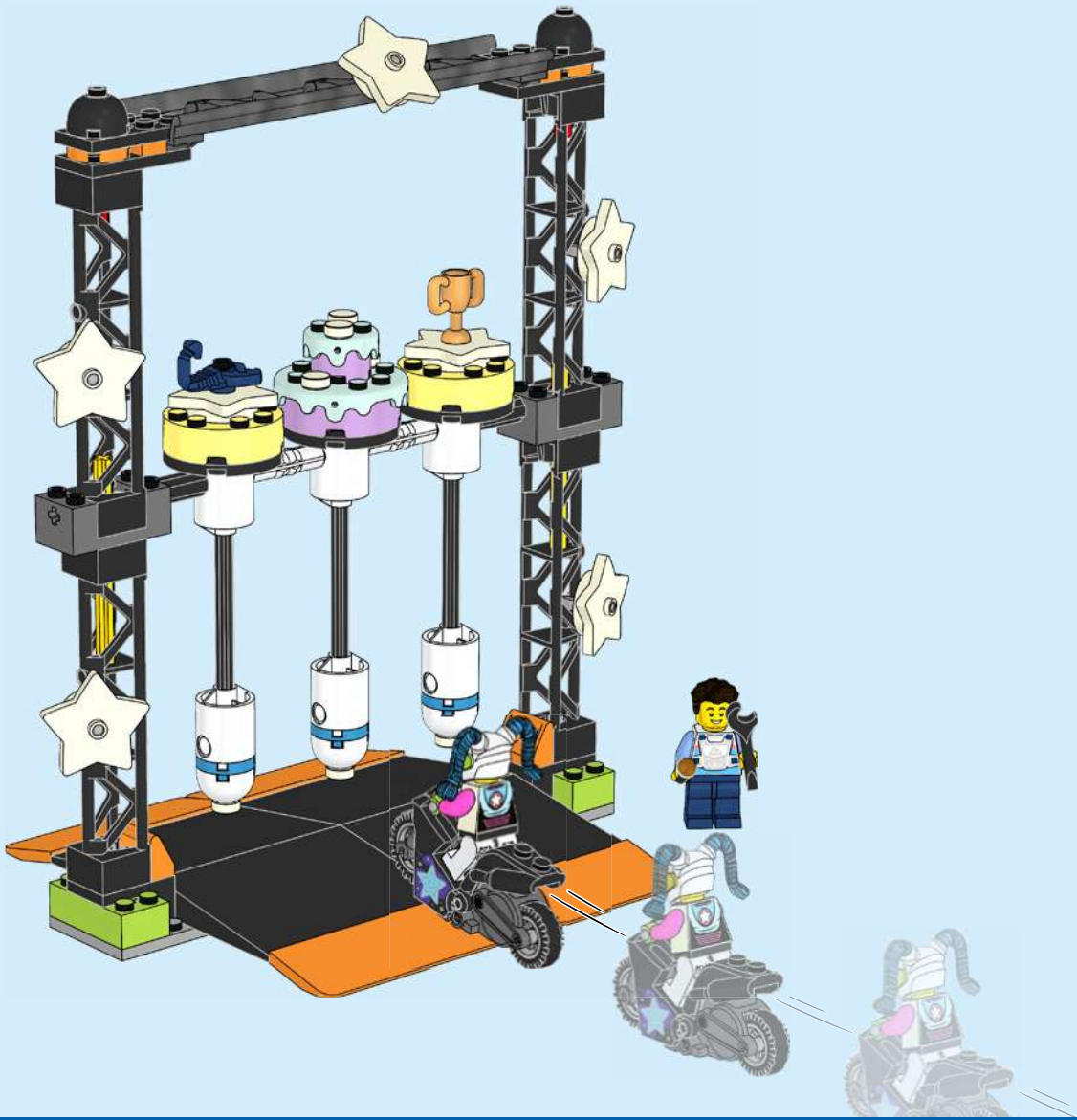



CITY



60331

+



60332

+



60333



60339

+



60338

+



60342

+



60341

+



60340



CITY

60337



60346

60349



60283



60330





1x
6382548



6x
4194010



3x
4216652



2x
6276052



1x
6356613



2x
4142865



5x
6129995



1x
302023



2x
6366133



1x
6267083



1x
6306822



2x
6130009



1x
6104328



2x
4512363



2x
4216660



1x
6391706



1x
6064174



4x
4667463



1x
400626



3x
6167800



4x
370926



2x
6039194



1x
6391707



3x
370726



4x
4161067



3x
6226919



1x
6305431



2x
6382530



2x
6030521



2x
4177932



2x
6253318



4x
6338339



1x
6313826



1x
6357611



3x
6092766



2x
6390840

8



5x
6278156



1x
6410997



1x
4258308



2x
4211815



2x
4211402



2x
6335115



1x
6391389



1x
6287323



1x
6251333



1x
4162916



1x
6152229

3



1x
6181575



1x
6289379



1x
6289380



1x
6223600



1x
6172421



7x
6284592



1x
6392225



7x
6350736

Customer Service
 Kundenservice
 Service Client
 Assistenza clienti
 Atención al cliente
 Serviço de Apoio ao Consumidor
 Ügyfélszolgálat
 Klientu apkalpošanas dienests
 Serviciul pentru clienț
 客户服务
 소비자서비스
 고객 서비스
LEGO.com/service

WIN

Terms & Conditions apply

Scan this QR code or go to **LEGO.COM/PRODUCTFEEDBACK** and give us your short feedback about this LEGO® set for a chance to win a cool LEGO prize.



GEWINNE

Scanne diesen QR-Code oder geh auf LEGO.COM/PRODUCTFEEDBACK

und gib uns dein kurzes Feedback zu diesem LEGO® Set. Dann hast du die Chance, einen coolen LEGO Preis zu gewinnen.

Es gelten die Teilnahmebedingungen

GAGNE

Scannez ce code QR ou rendez-vous sur LEGO.COM/PRODUCTFEEDBACK

pour donner votre avis sur ce produit LEGO® et avoir une chance de gagner un prix LEGO.

Voir Conditions Générales

GANAN

Escanea este código QR o visita LEGO.COM/PRODUCTFEEDBACK

y comparte con nosotros tu opinión sobre este set LEGO® para tener la oportunidad de ganar un fantástico premio LEGO.

Términos y Condiciones aplicables

获取奖品

只需扫描此二维码或访问 LEGO.COM/PRODUCTFEEDBACK,

就这款乐高®套装提供简短反馈, 就有机会赢得很酷的乐高奖品。

《条款及条件》适用