



NINJAGO

71781





LEGO.com/sustainable-packaging

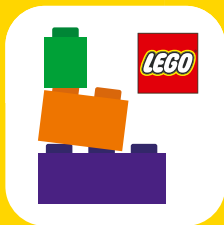

BUILDER



Apple and the Apple logo are trademarks of Apple Inc., registered in the U.S. and other countries and regions. App Store is a service mark of Apple Inc. Google Play and the Google Play logo are trademarks of Google LLC. Tencent and the Tencent logo are trademarks of Tencent Inc.

 LEGO.com/devicecheck

EN Ask parents' permission before going online | **DE** Eltern um Erlaubnis bitten, bevor du online gehst | **FR** Demande l'autorisation d'un parent avant d'aller en ligne | **IT** Chiedi il permesso ai tuoi genitori prima di andare online | **ES** Pídeles permiso a tus papás antes de conectarte a Internet | **PT** Pede autorização aos pais antes de acederes online | **JA** オンラインになる前に ほご者の方のきよかをもらおう | **ZH** 上网前应先征得父母的同意 | **KO** 온라인 접속 전에 보호자 동의가 필요합니다 | **RU** Спроси разрешения у родителей, прежде чем заходить в интернет | **PL** Poproś rodziców o zgodę, zanim wejdiesz do Internetu | **CS** Než půjdeš na internet, požádej rodiče o svolení | **SK** Skôr než pôjdeš na internet, vypýtaj si povolenie od rodičov | **HU** Kérj szülői engedélyt, mielőtt online csatlakoznál! | **RO** Cere permisiunea părinților înainte de a te conecta online | **BG** Поискайте разрешение от родител, преди да влезете онлайн | **LV** Pirms došanās tiešsaistē palūdz atļauju vecākiem | **ET** Enne Interneti kasutamist küsi vanematelt luba | **LT** Prieš prisijungdami prie interneto, atsiklauskite tėvų



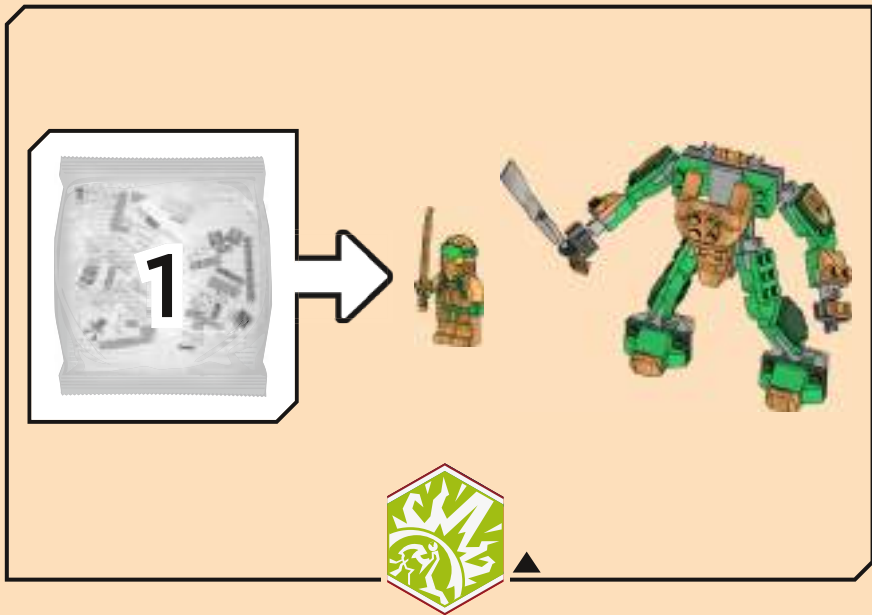



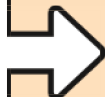



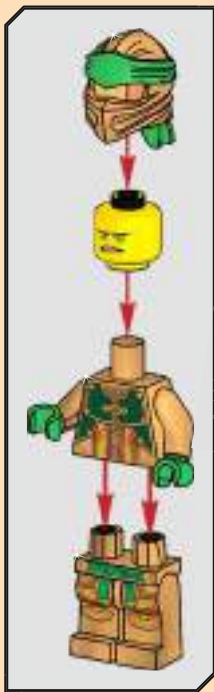





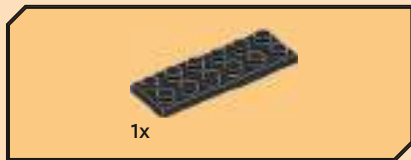

1





2x

2





3

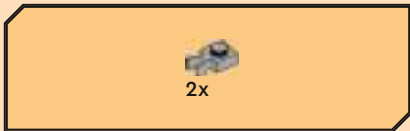

4



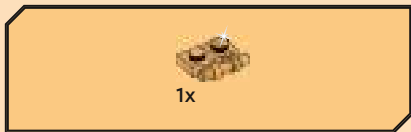

5



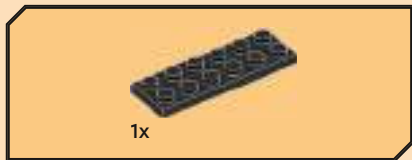

6



7



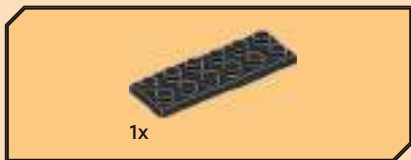

8





9



10





2x

11



18



12



13

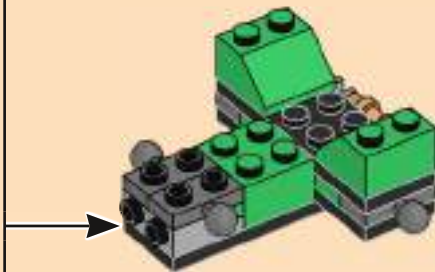



1x



1x

14

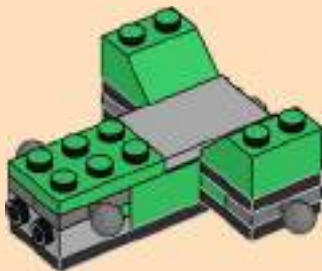



15

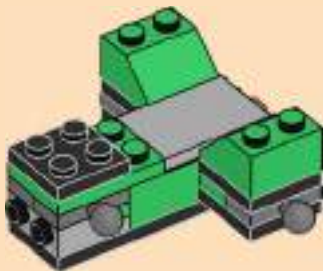

16

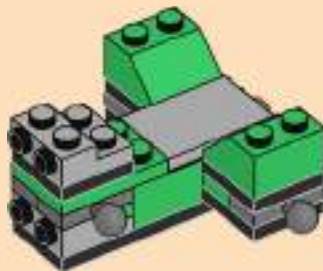



17

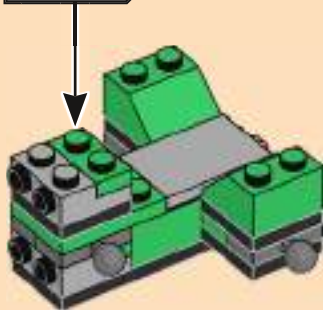



18

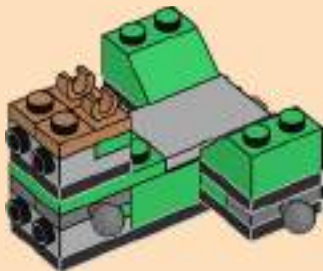

19

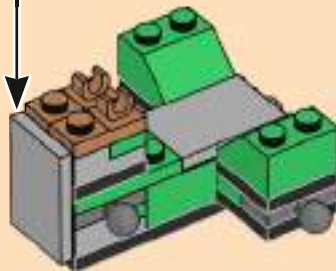
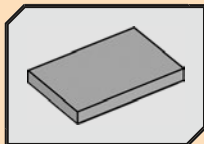



1x

20

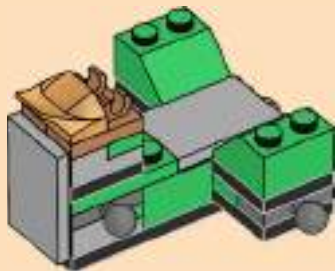

24



21

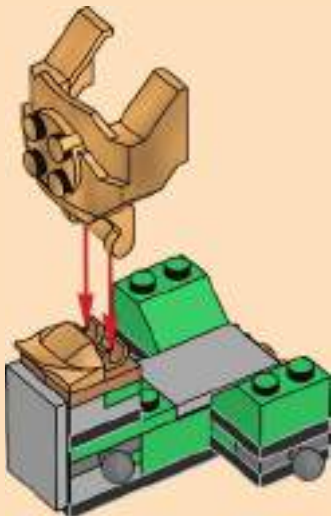

22

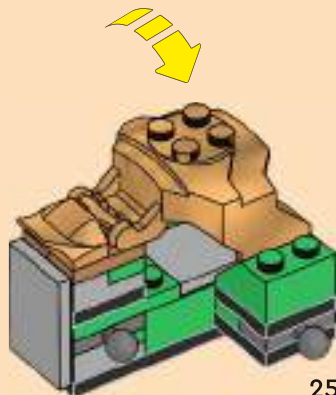

25



23





1x

24



1x

25





1x

26





1x

27



1x

28





1x

29



30

30

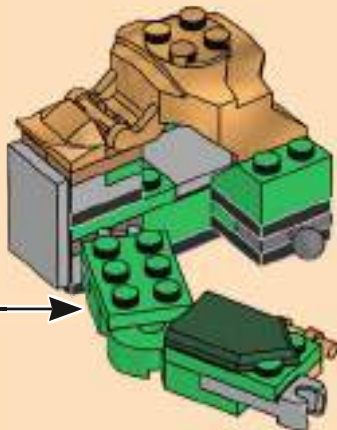



31



32



1x

32



1x

33





1x

34



34

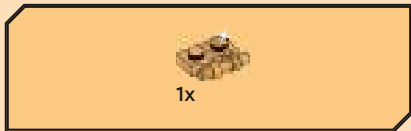

35



36





1x

37



36

38

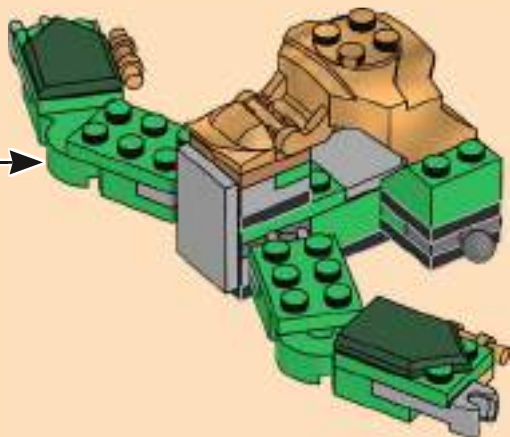

39

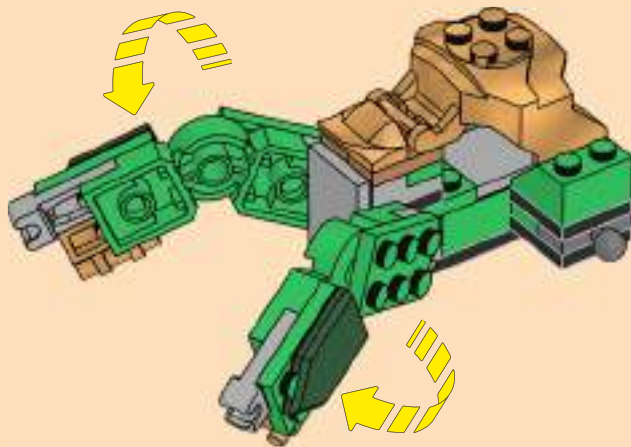

38



2x



1x

40

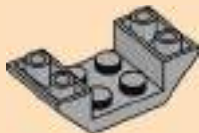

1x

41

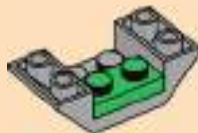



1x

42



40



43



44





45



42



46



47



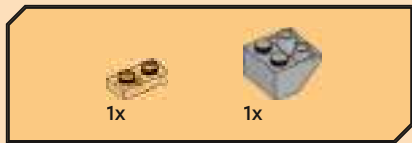

48

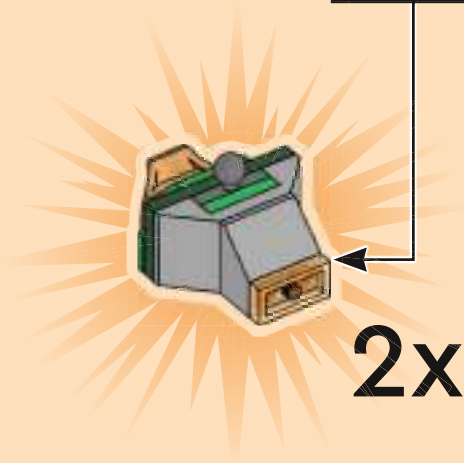
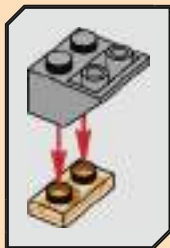

2x

49

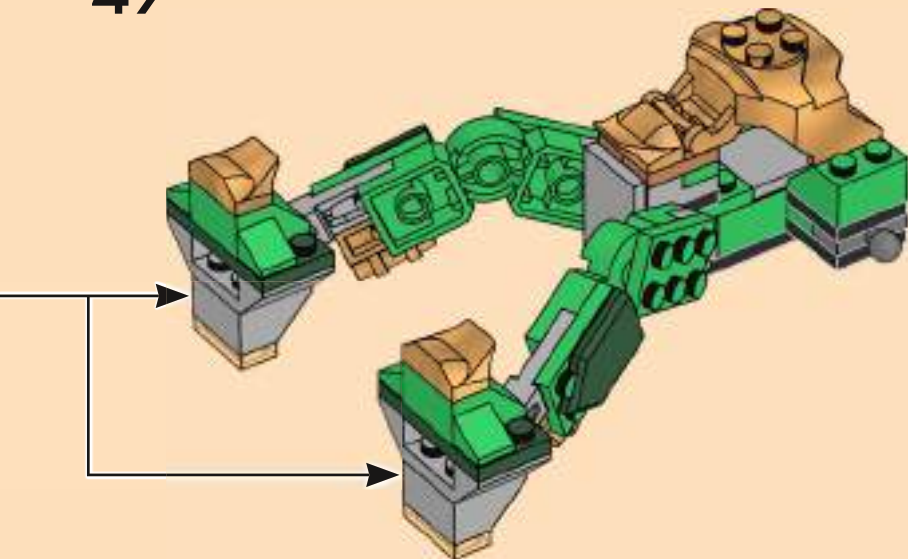



50





2x

51



1x

52





1x

53



1x

54



55





56





2x

57



1x

58





1x

59



52



1x

60



61

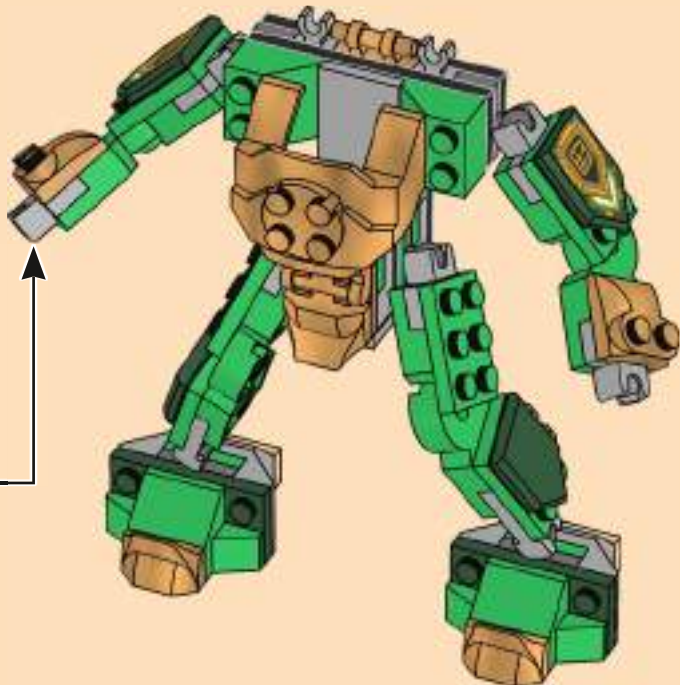



2x



2x



2x



2x

62

1



2



3



2x

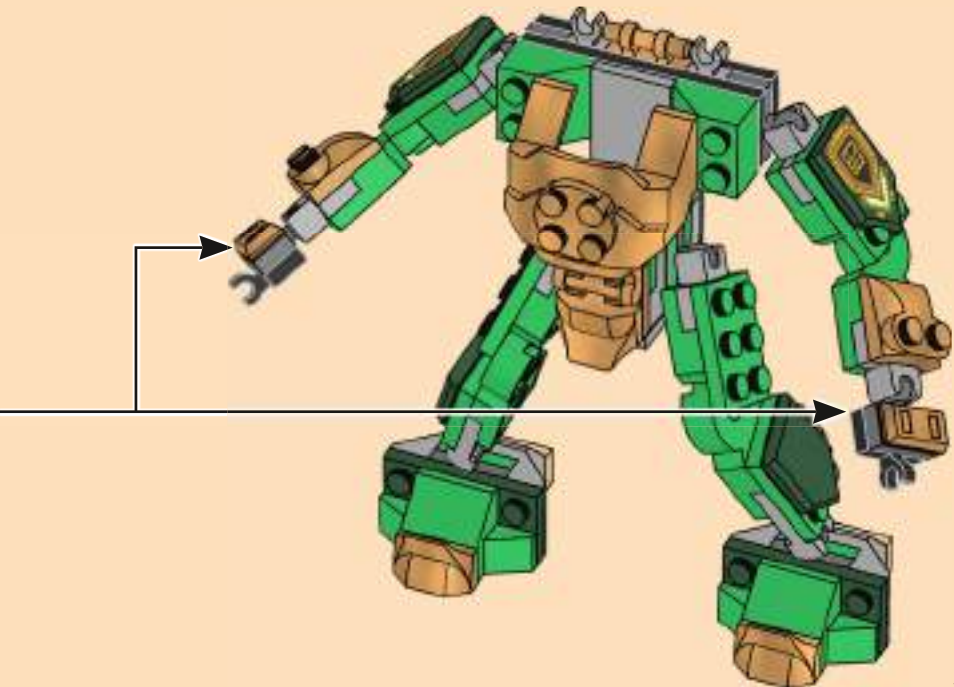

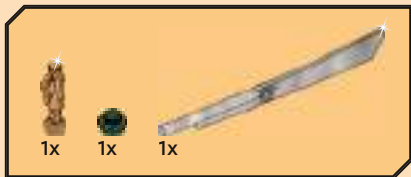

63

1



2



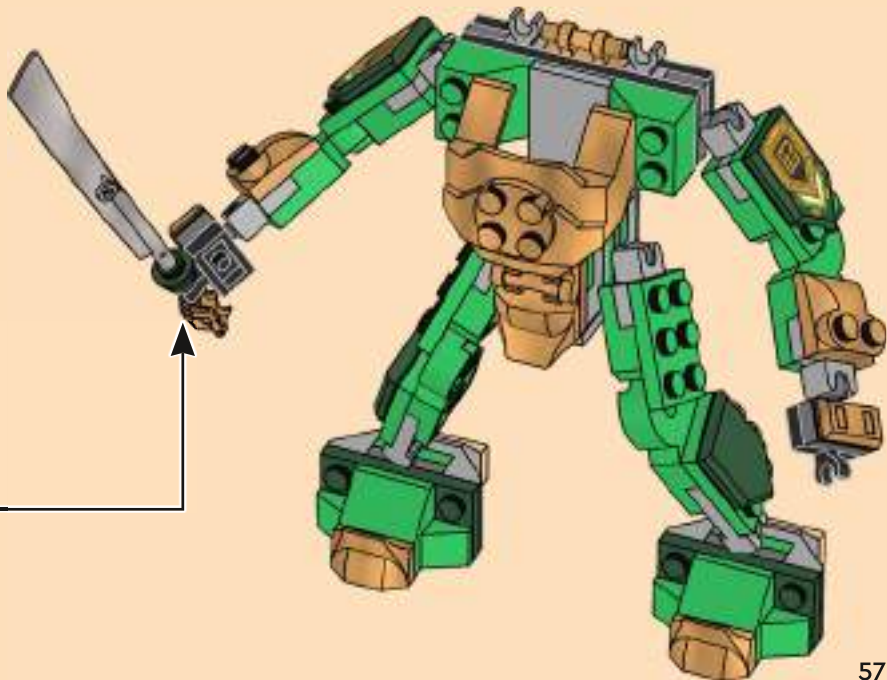

64



58



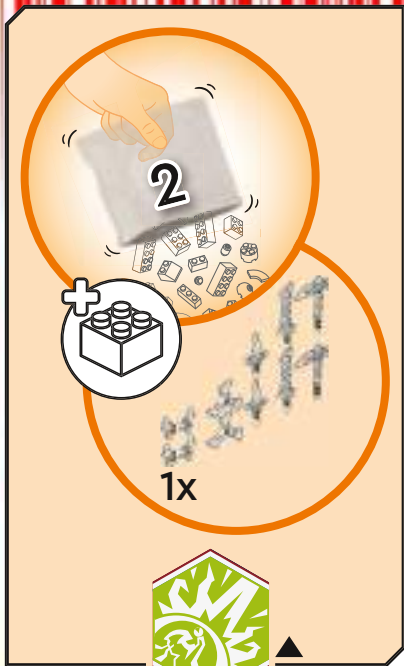

1

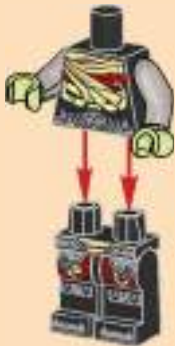

2

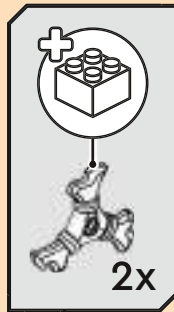

3

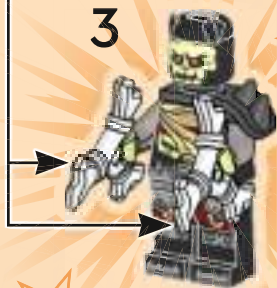

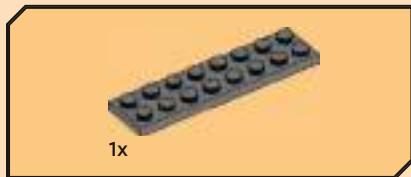

1





2

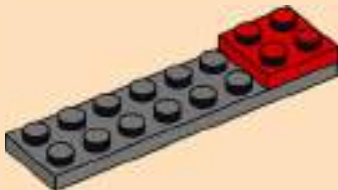

3

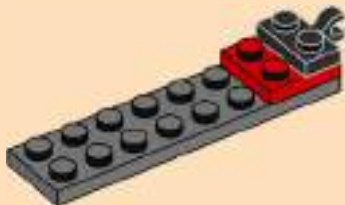



1x

4





5



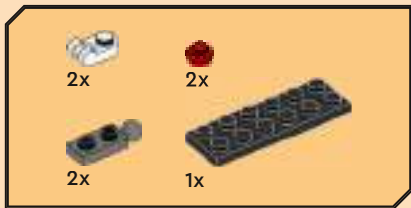

6

1



2



3

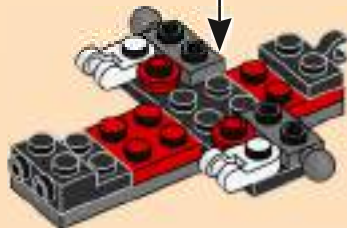

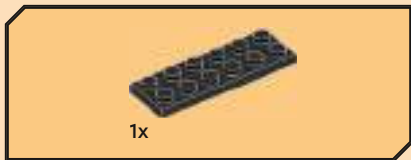

7

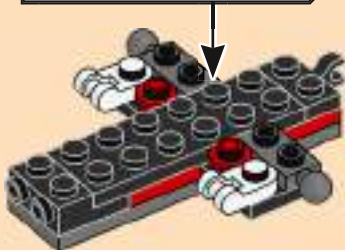



1x

8





9

1



2



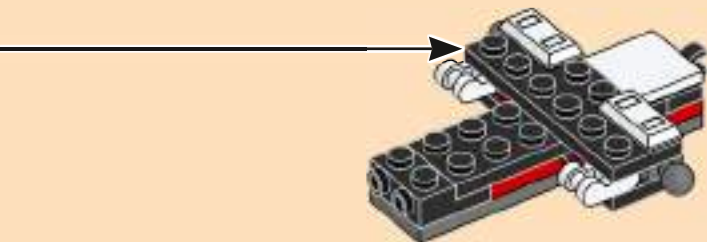



1x

10

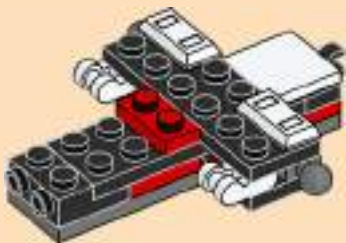



2x

11

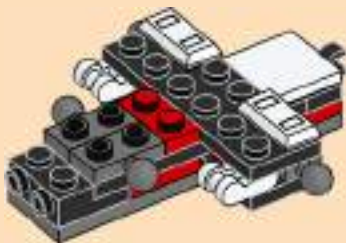

1x

12





2x

13

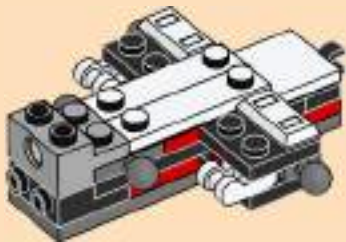



14

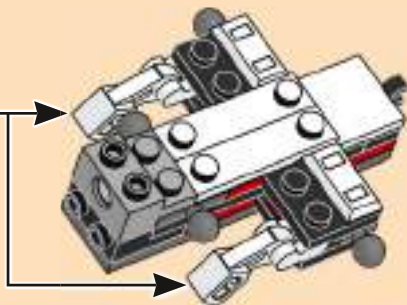
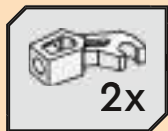



15

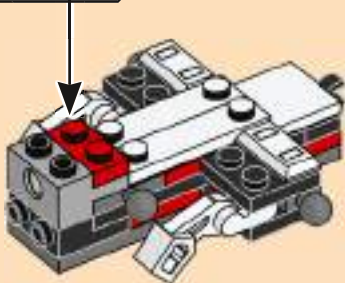



1x

16

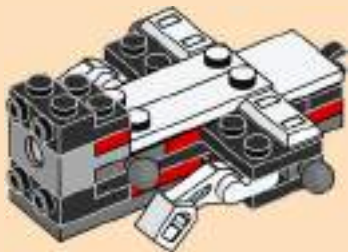

1x

17





2x

18





19

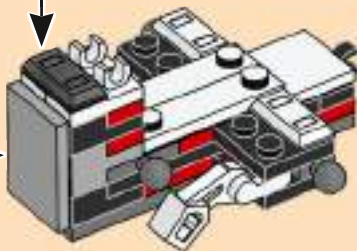
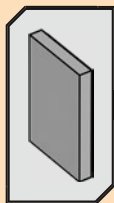

20

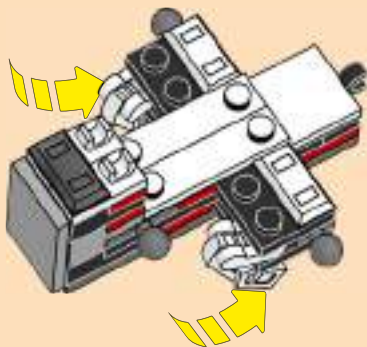

80



21

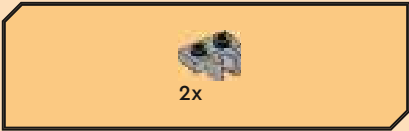

22





23



24





25



26

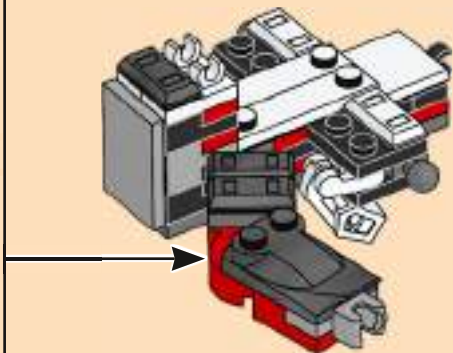



27





2x

28



1x

29





30



31



32

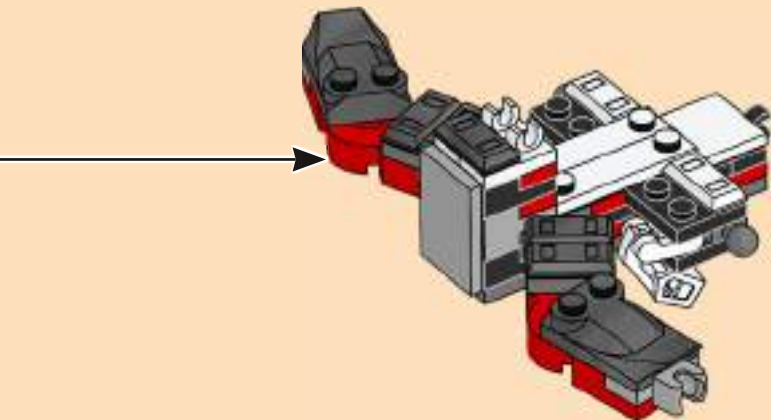

33

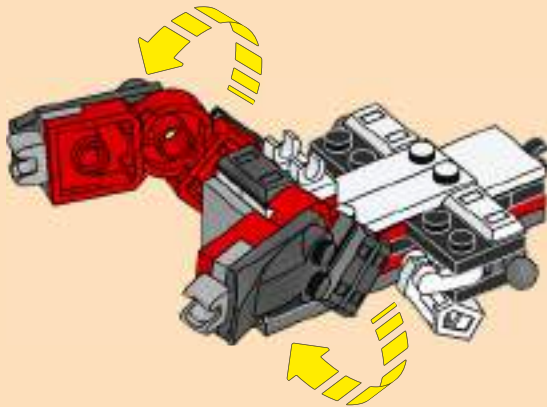

88



2x



1x

34



1x

35





1x

36





37



38





1x

39



40



41



2x

42

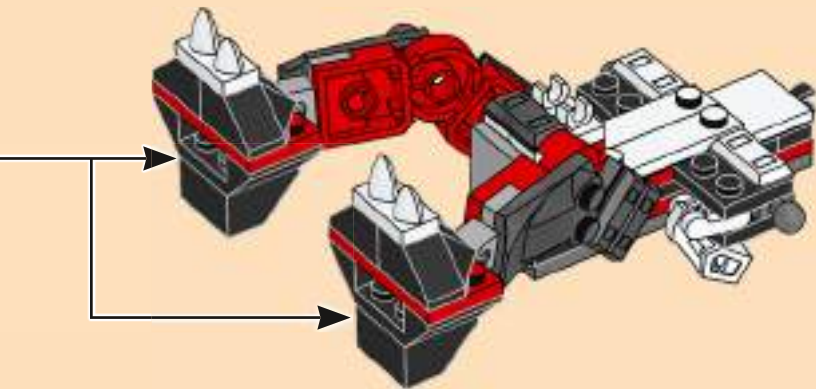

94

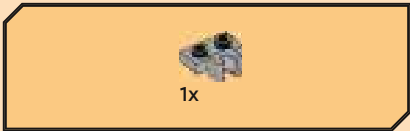

43

44





1x

45





46

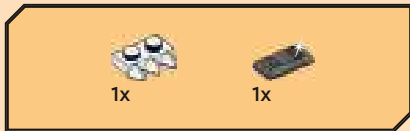

47

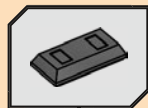



1x

48



49

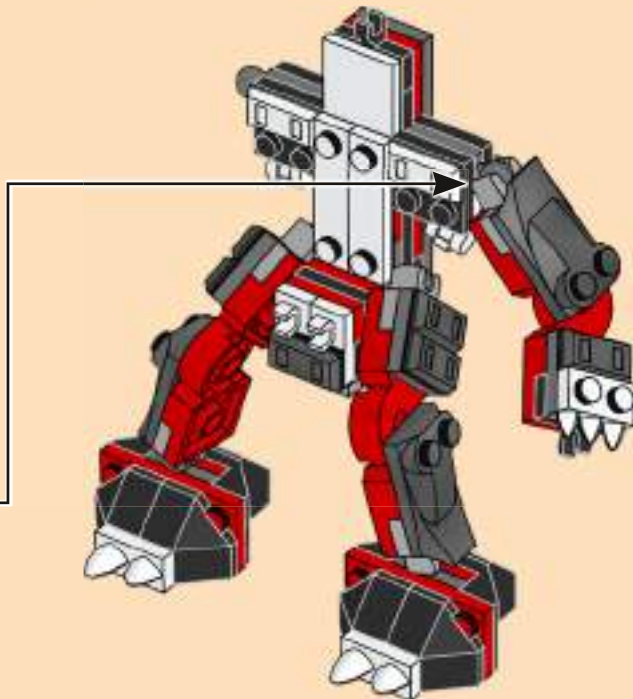



50



100

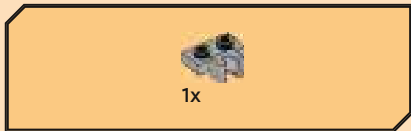

51



52

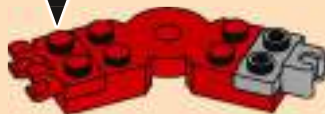



53





1x

54



1x



1x

55

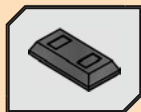



1x

56



57

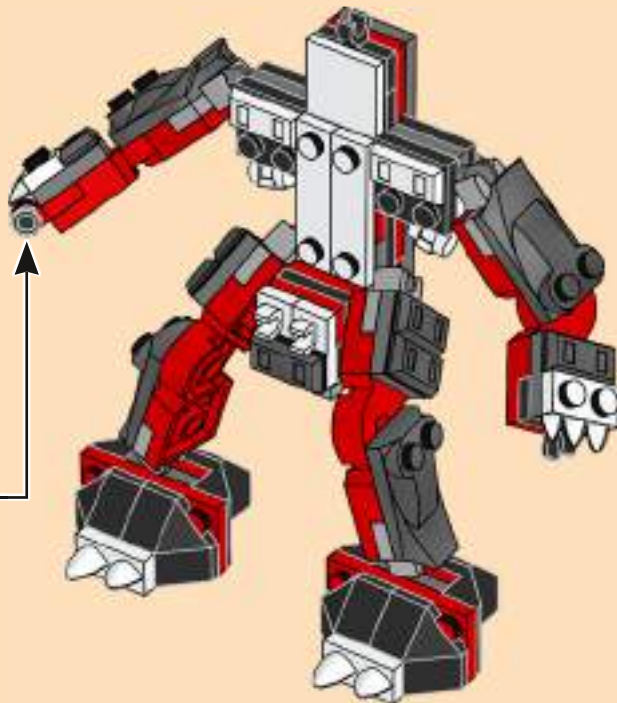

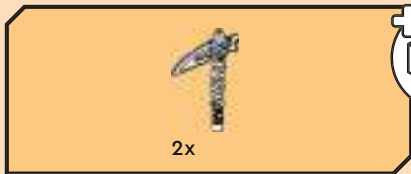

58

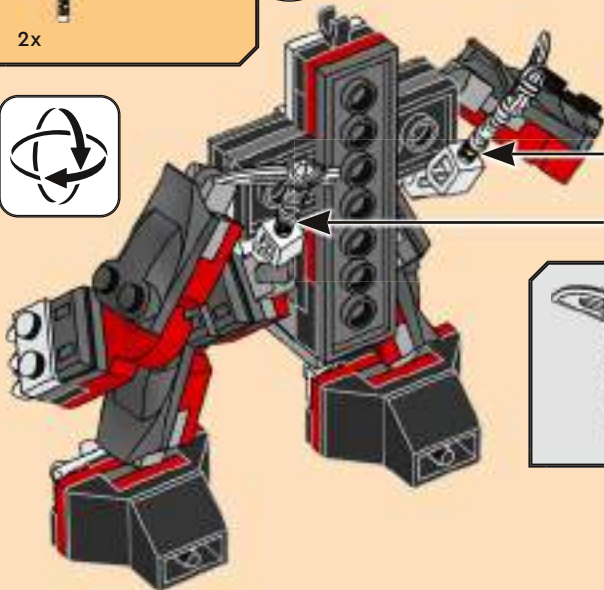



59



60





2x

61





1x

62



2x

63

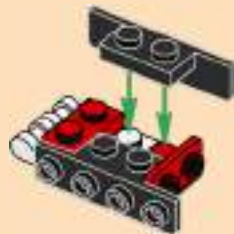



1x

64





65

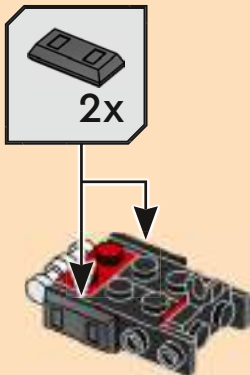

66

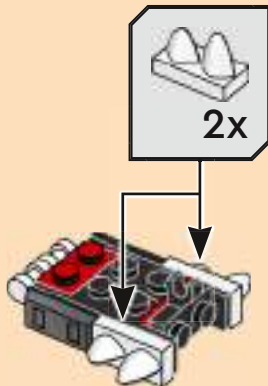

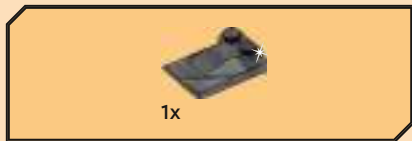

67



68



69

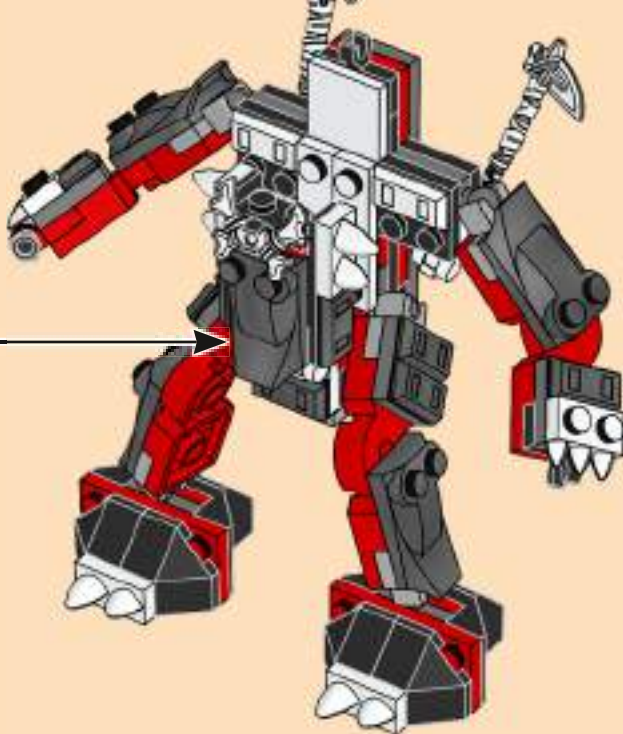



70





71



72





73

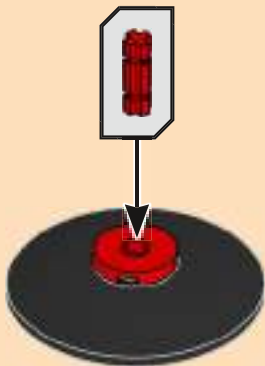

74

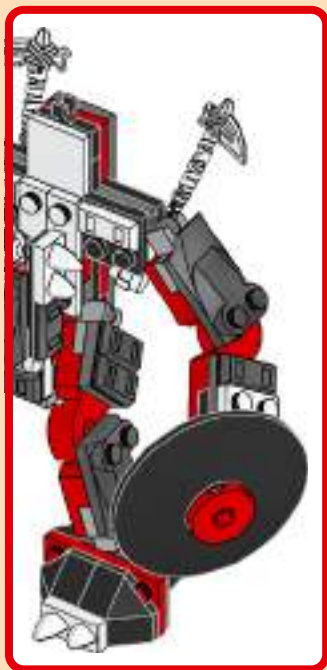

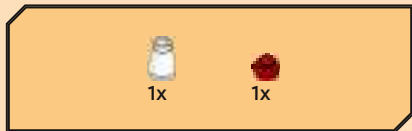

75

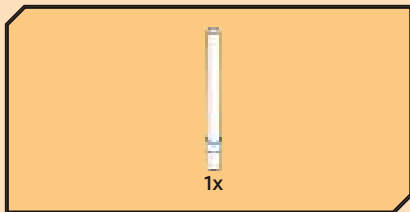

76





77



78



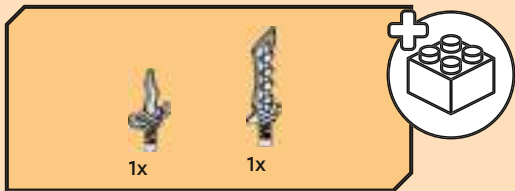

79

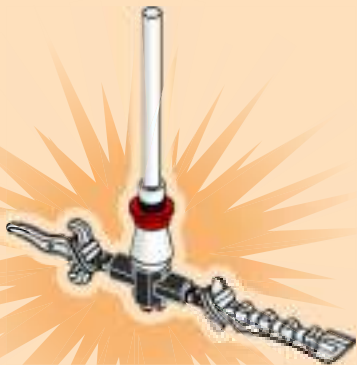

2x

80

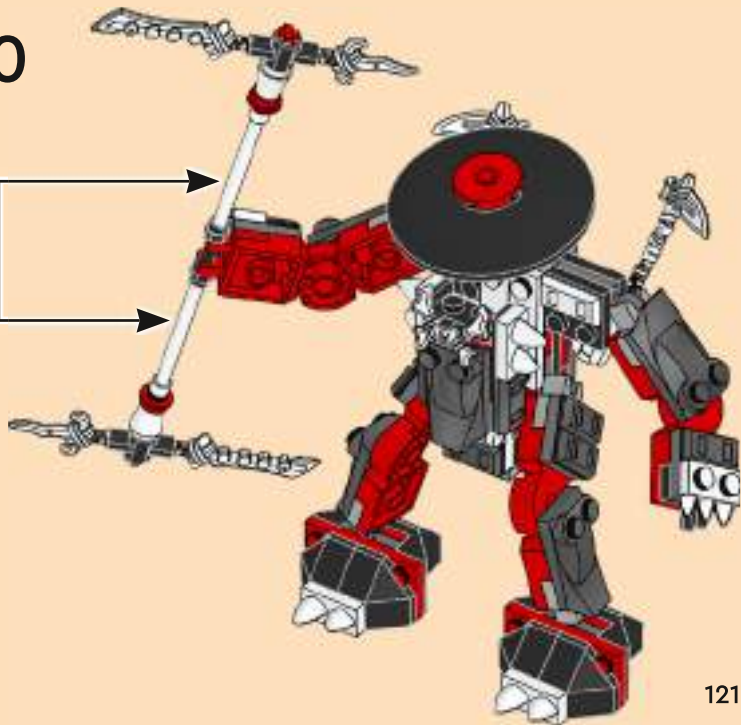

81

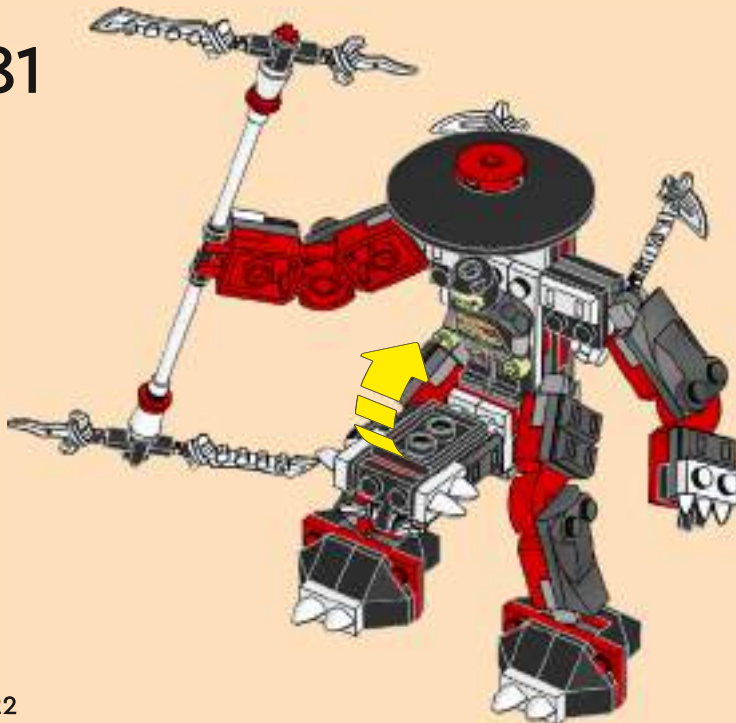

122





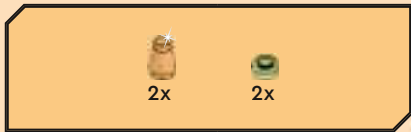

1

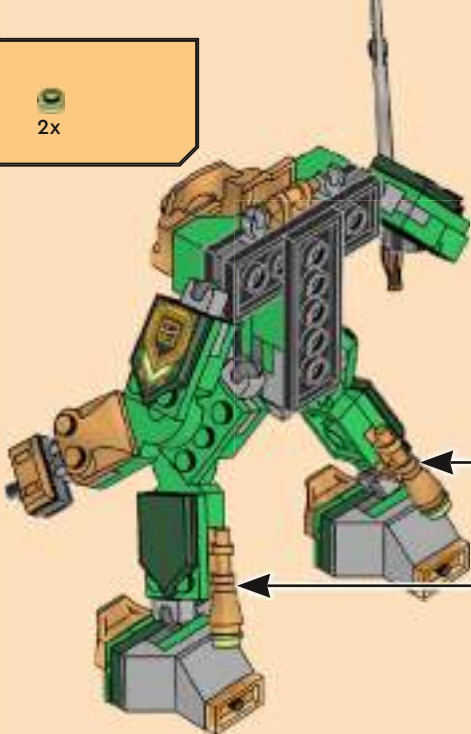



2

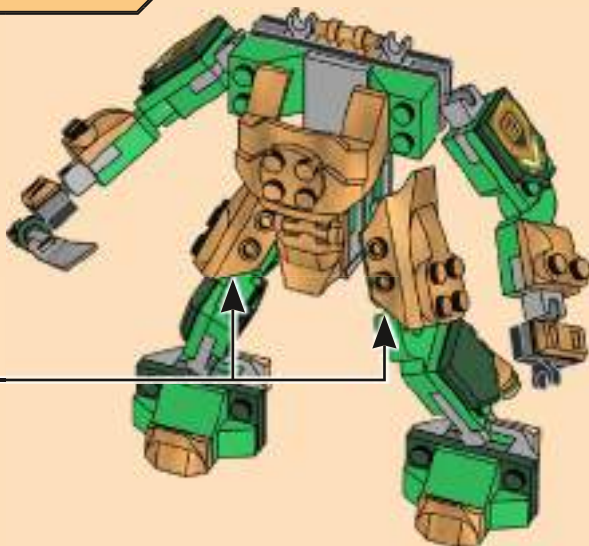



3

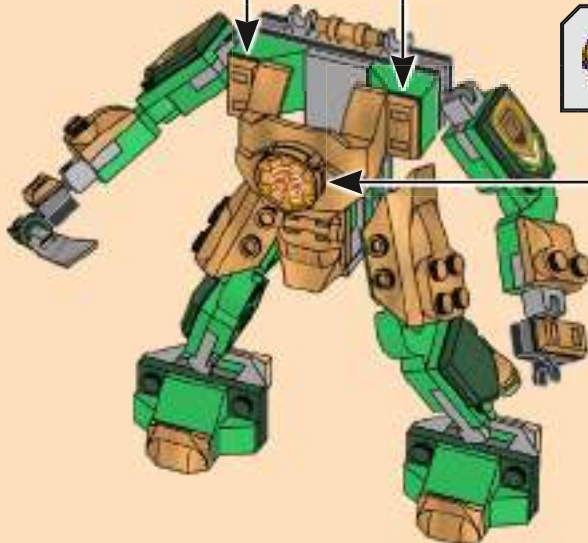



4

1



2



3



2x

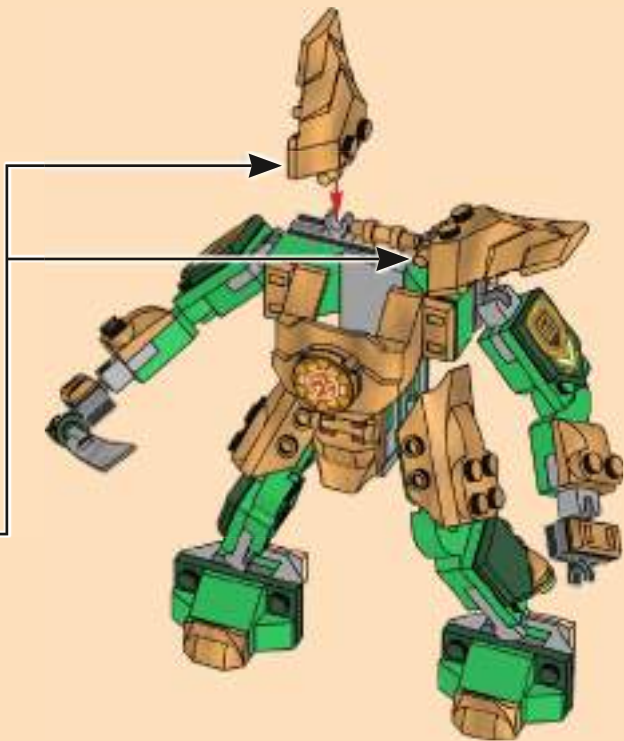

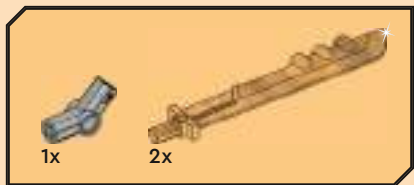

5

1



2

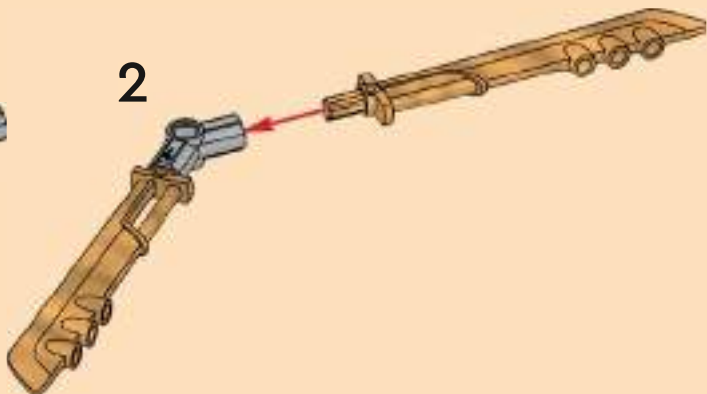

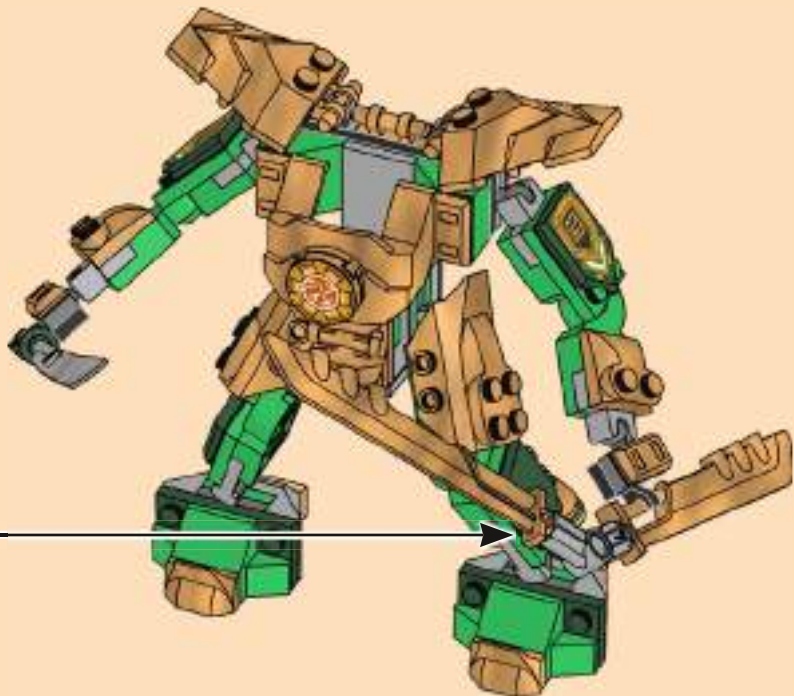

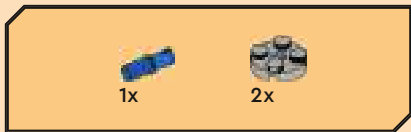

6



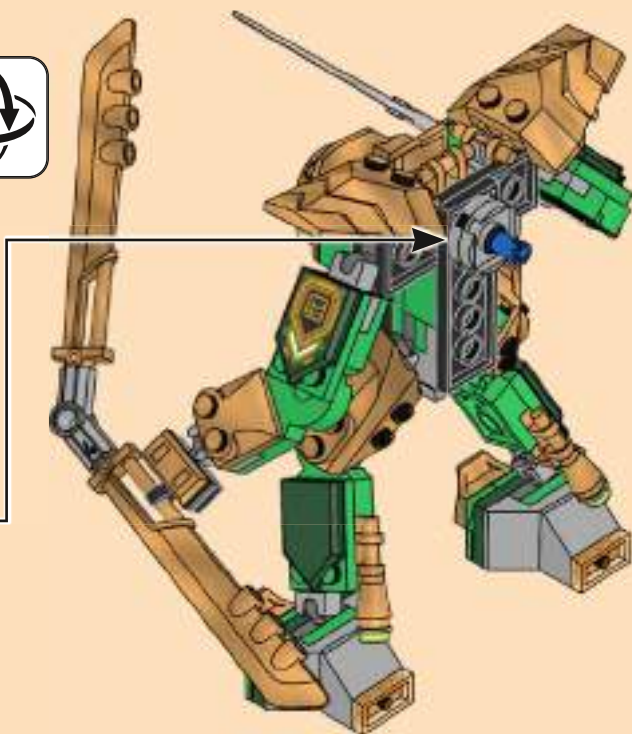

7

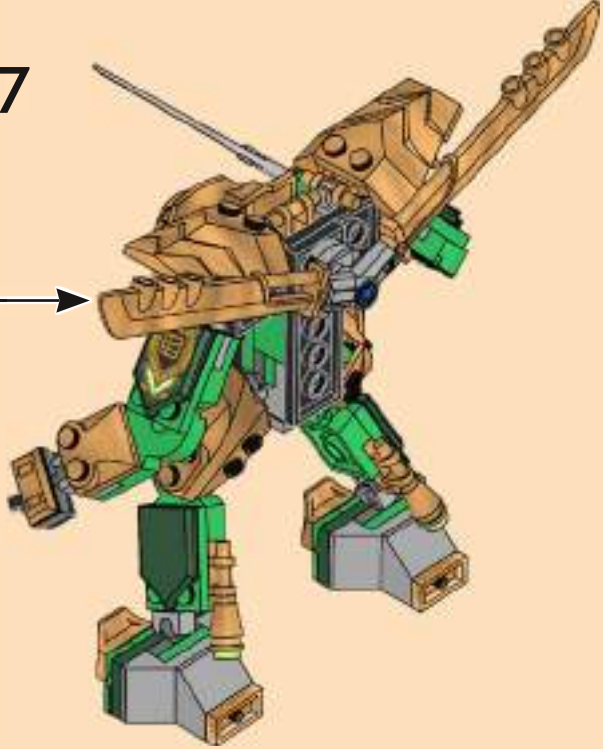
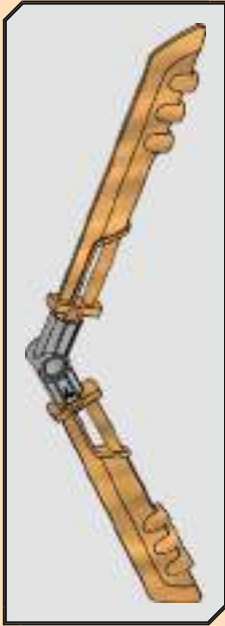





8

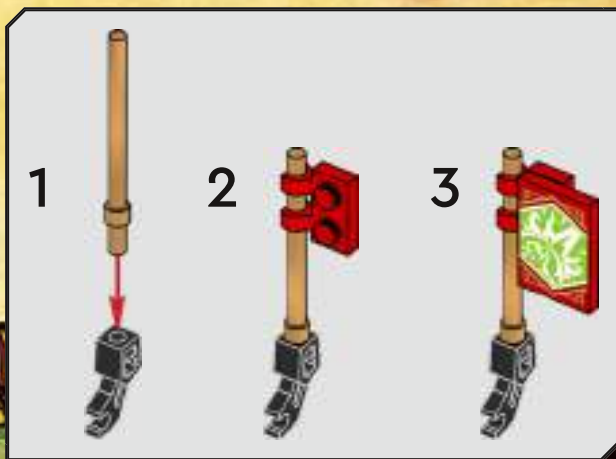

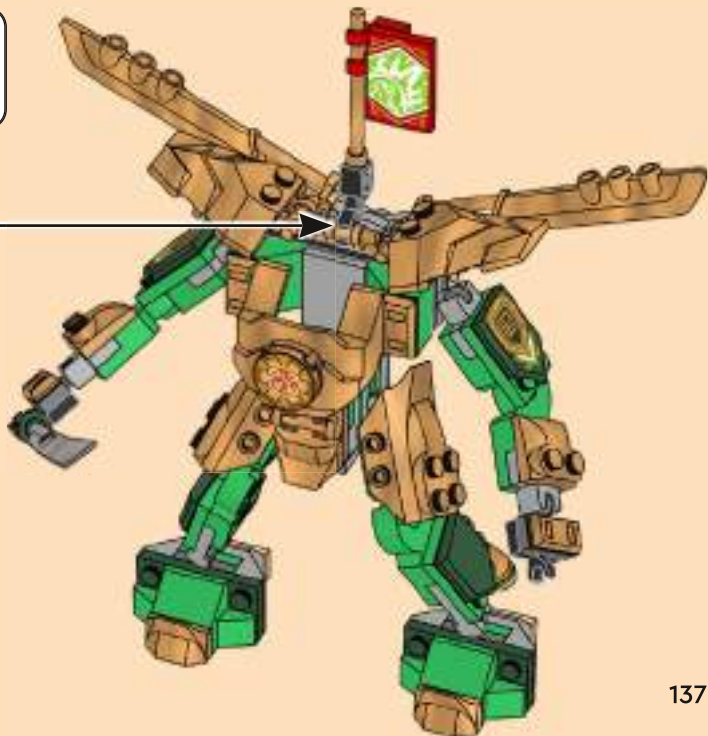





NINJAGO



71785



71786



71787



71780



71783



71781



71782



71784

EXPLORE MORE!



Explore more / Mehr entdecken / En savoir plus / Esplora di più /
Explora más / Explora mais / 探索更多 / Узнайте больше /
Zobacz więcej / Objev více / Objav viac / Tudj meg többet! /
Descoperă mai multe / Разгледайте още / Uzzini vairāk /
Uuri lähemalt / Atrask daugiau



Blue-Ocean-AG.com/LEGONinjagoMagazine

Flag illustrations: stockdevil - stock.adobe.com

Flag illustrations / Abgebildete Flaggen / Illustrations de drapeaux / Illustrazioni delle bandiere /
Ilustraciones de banderas / Ilustrações de bandeiras / 旗帜插图 / Иллюстрации флагов /
Ilustracje — flagi / Obrázky vlajek / Obrázky vlajek / Zászló illusztrációk / Ilustratji cu steaguri /
Иллюстрации на знамена / Karogu attēli / Lippude pildid / Vėliavų iliustracijos



2x
4518400



2x
6174937



1x
403201



2x
6276864



2x
6210076



2x
6347309



1x
6417344



4x
6046384



2x
6046381



1x
306801



2x
4515364



6x
302321



1x
6089698



2x
6170419



1x
6009016



2x
6249091



2x
6360036



2x
302221



1x
6421043



2x
302021



4x
6375427



4x
6223427



3x
4142865



1x
6102138



1x
6230571



2x
6421048



2x
6285134



2x
4586057



4x
4546705



6x
302328



4x
303928



1x
300328



7x
302128



4x
6372712



1x
6331084



1x
6421033



1x
6406666



2x
6280097



1x
6421035



1x
6276867



5x
6313116



4x
6176768



2x
6425507



1x
302226



2x
6052126



1x
6424325



2x
6168620



1x
302126



2x
4188534



2x
6296894



4x
4211475



1x
4206482



1x
6191962



1x
6058341



6x
379526



12x
6043656



1x
6326478



2x
6435857



2x
6043639



2x
4654577



3x
6171894



1x
6262905



2x
4211517



12x
6039479



2x
6123814



4x
4211094



1x
4210997



2x
6347304



2x
6240217



2x
6240206



1x
6224825



2x
4529247



1x
6424355



1x
6341738



1x
6421032



4x
6207933



3x
6375715



5x
6279731



2x
4286597



1x
6424356



1x
6116596



2x
6376233



2x
6371694



1x
6371693



1x
6170470



2x
6330240



1x
6378729



5x
6167034



9x
6208447



1x
6248797



[LEGO.com/service](https://www.LEGO.com/service)

YOU COULD

WIN



Scan this QR code or go to
LEGO.COM/PRODUCTFEEDBACK and give us
your short feedback about this LEGO® set
for a chance to win a cool LEGO prize.

Terms and Conditions apply*

DE: Du könntest GEWINNEN. Es gelten die Teilnahmebedingungen* **FR: Tu pourrais GAGNER.** Des conditions s'appliquent* **IT: Potresti VINCERE tu.** Termini e condizioni sono applicabili* **ES: Puedes GANAR.** Aplican términos y condiciones* **PT: Poderá GANHAR.** Aplicam-se termos e condições* **JA: プレゼント付き! 利用規約が適用されます*** **ZH: 轻松获奖. 条款和条件适用*** **KO: 상품의 주인이 되어보세요. 소정의 약관이 적용됩니다*** **RU: Вы можете ВЫИГРАТЬ.** Действуют положения и условия* **PL: Szansa na WYGRANĄ.** Obowiązują warunki korzystania* **CS: Máte šanci VYHRÁT.** Platí všeobecné smluvní podmínky* **SK: Máte šancu VYHRATĚ.** Platia všeobecné zmluvné podmienky* **HU: TE IS NYERHETSZ.** Felhasználási feltételek érvényesek* **RO: Ai putea CĂȘTIGA.** Se aplică termenii și condiții* **BG: Можете да СПЕЧЕЛИТЕ.** Има определени правила и условия* **LV: Tu vari LAIMĒT.** Ir spēkā noteikumi un nosacījumi.* **ET: Sul on võimalus VÕITA.** Kehtivad tingimused* **LT: Jūs galite LAIMĖTI.** Taikomos sąlygos*

*[LEGO.com/productfeedback-terms](https://www.lego.com/productfeedback-terms)