



Friends

41740



WARNING: CHOKING HAZARD.
Toy contains small parts and a small ball.
Not for children under 3 years.



Get excited about our new packaging!

We're switching from plastic to paper-based packaging. That's why you might find a mix of paper and plastic in our boxes!

Nos nouveaux emballages vous emballeront !

Nous passons des emballages en plastique aux emballages à base de papier. C'est pourquoi vous pourriez trouver un mélange de papier et de plastique dans nos boîtes !

¡Te presentamos nuestros nuevos empaques!

Estamos sustituyendo las bolsas de plástico por bolsas con base de papel. ¡Por eso, puedes encontrar una mezcla de papel y de plástico en nuestras cajas!

[LEGO.com/sustainable-packaging](https://www.lego.com/sustainable-packaging)



BUILDER

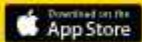

Apple and the Apple logo are trademarks of Apple Inc., registered in the U.S. and other countries and regions. App Store is a service mark of Apple Inc. Google Play and the Google Play logo are trademarks of Google LLC. Tencent and the Tencent logo are trademarks of Tencent Inc.

🔍 LEGO.com/devicecheck

EN Ask parents' permission before going online | **DE** Eltern um Erlaubnis bitten, bevor du online gehst | **FR** Demande l'autorisation d'un parent avant d'aller en ligne | **IT** Chiedi il permesso ai tuoi genitori prima di andare online | **ES** Pídeles permiso a tus papás antes de conectarte a Internet | **PT** Peça autorização aos pais antes de acederes online | **JA** オンラインになる前に 保護者の方のきょかをもらおう | **ZH** 上网前应先征得父母的同意 | **KO** 온라인 접속 전에 보호자 동의가 필요합니다 | **RU** Спроси разрешение у родителей, прежде чем заходить в интернет | **PL** Poproś rodziców o zgodę, zanim wejdziesz do Internetu | **CS** Než půjdeš na internet, požádej rodiče o svolení | **SK** Skôr než pôjdeš na internet, vypýtaj si povolenie od rodičov | **HU** Kérj szülő engedélyt, mielőtt online csatlakoznál! | **RO** Cere permisiunea părinților înainte de a te conecta online | **BG** Поискайте разрешение от родители, преди да влезете онлайн | **LV** Pirms došanās tiešsaistē palūdz atļauju vecākiem | **ET** Enne Interneti kasutamist küsi vanematelt luba | **LT** Prieš prisijungdami prie interneto, atsilauškite tėvų

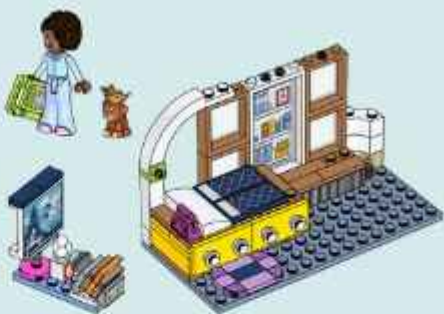

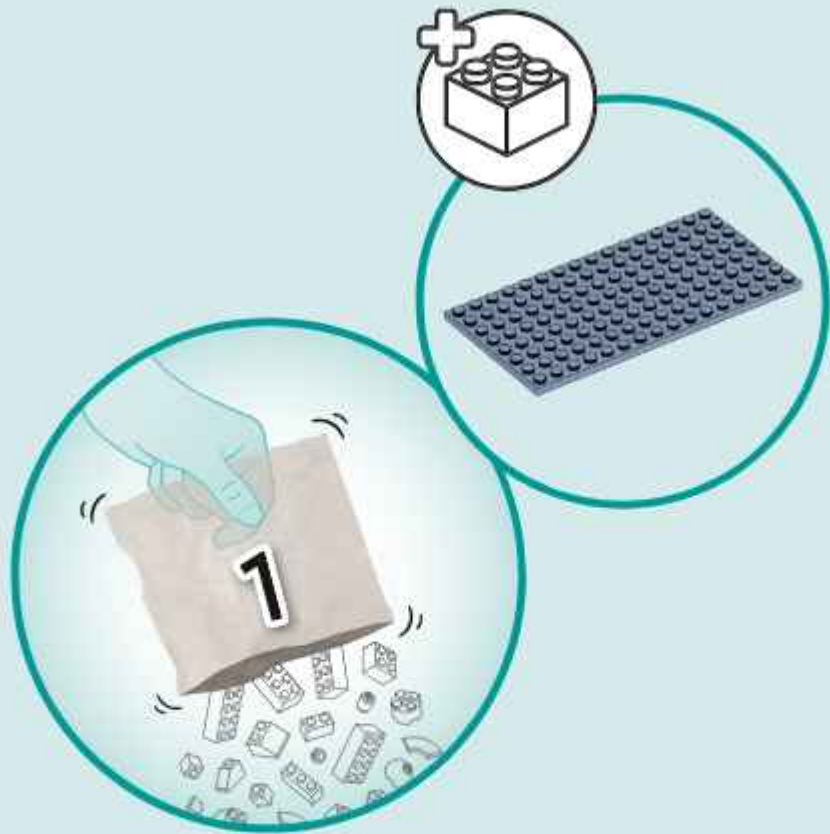

AVERTISSEMENT :

RISQUE D'ÉTOUFFEMENT. Le jouet contient des petites pièces ainsi qu'une petite boule. Il ne convient pas aux enfants de moins de 3 ans.



ADVERTENCIA:

PELIGRO DE ASFIXIA.

Juguete que contiene partes pequeñas y una pelota pequeña. No recomendado para niños menores de 3 años.

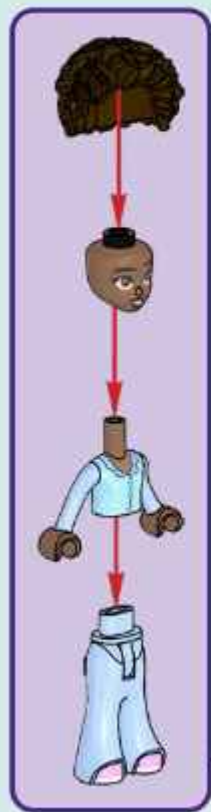

ALIYA



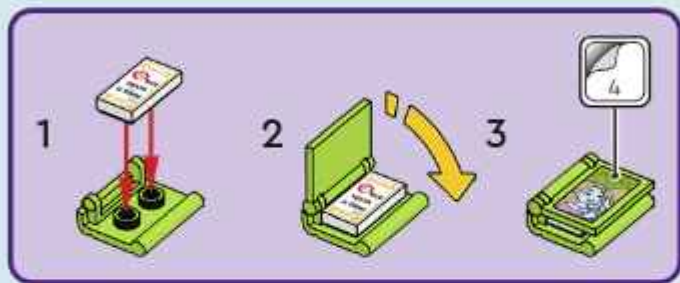

AIRA

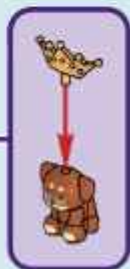





1

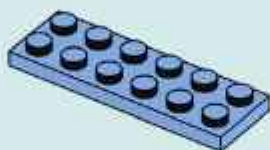

2





2x

3

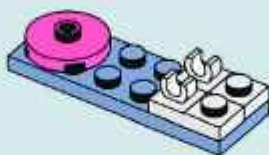

1x

4

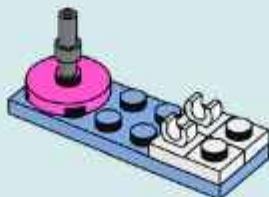



5

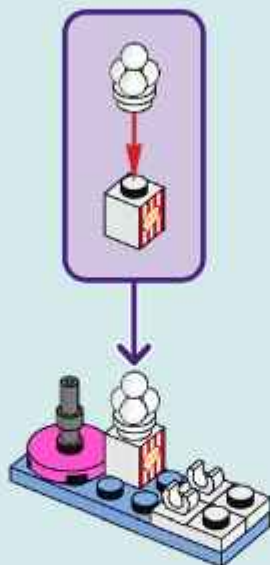

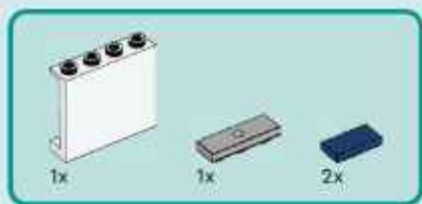

6



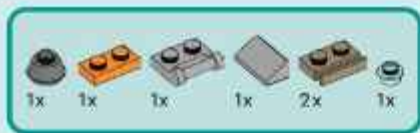

7

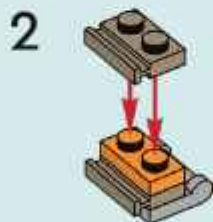
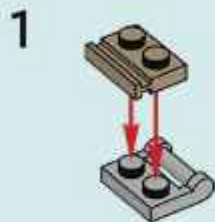
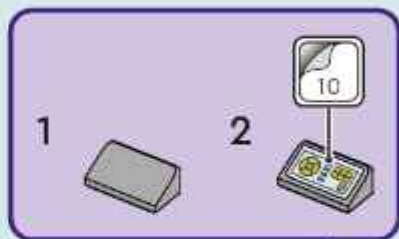



4

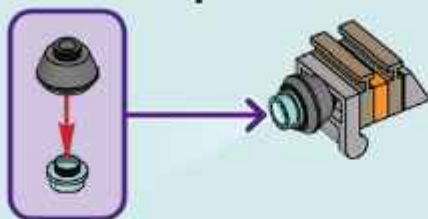



1x

8



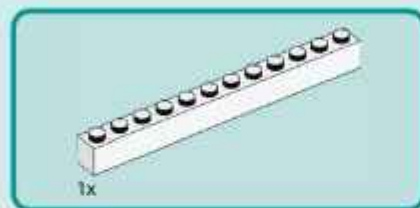

1

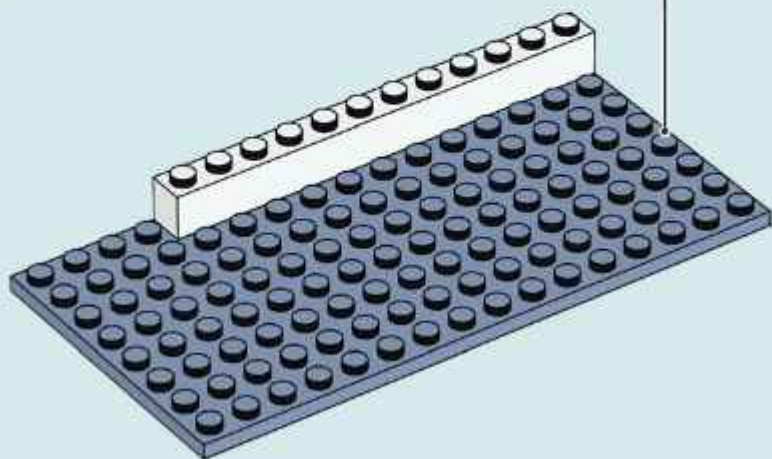



2

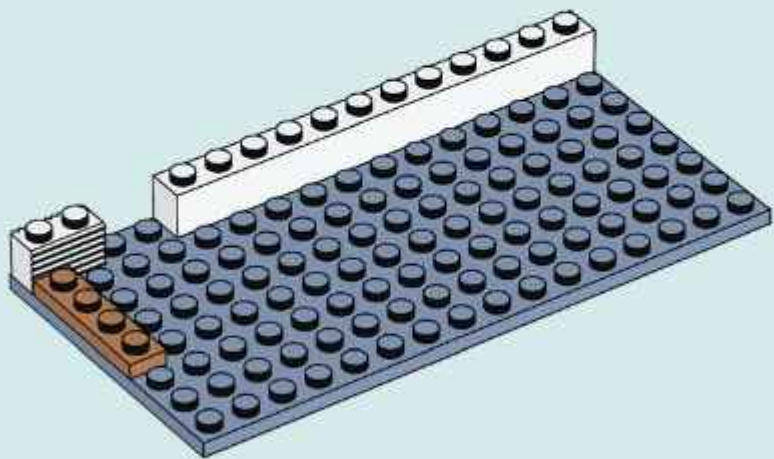



3

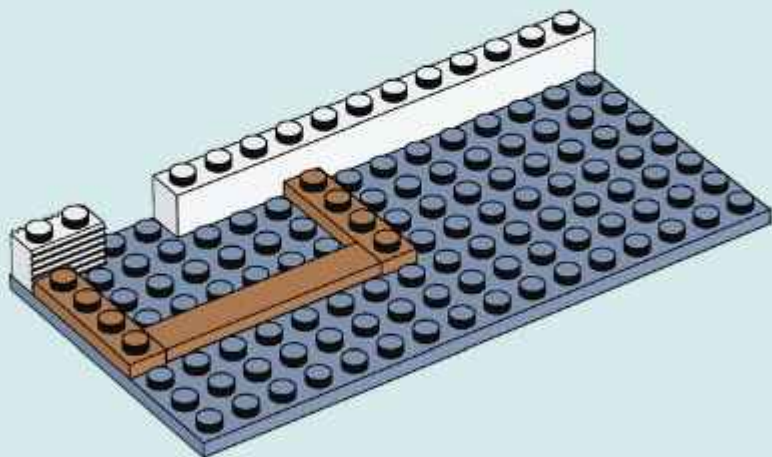



4

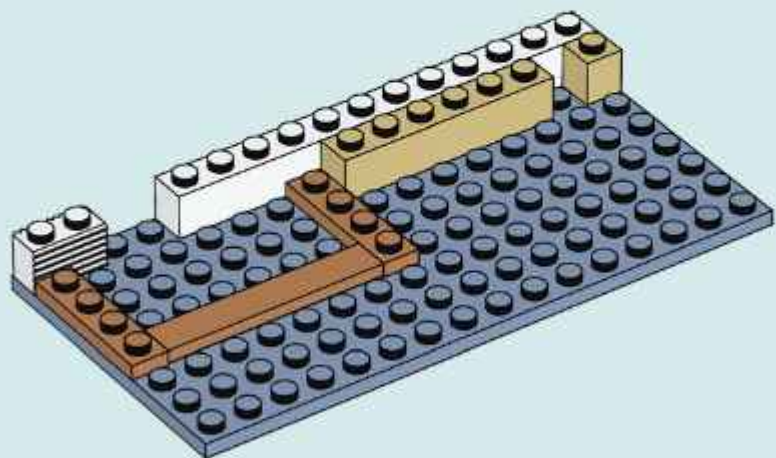



3x



1x

5

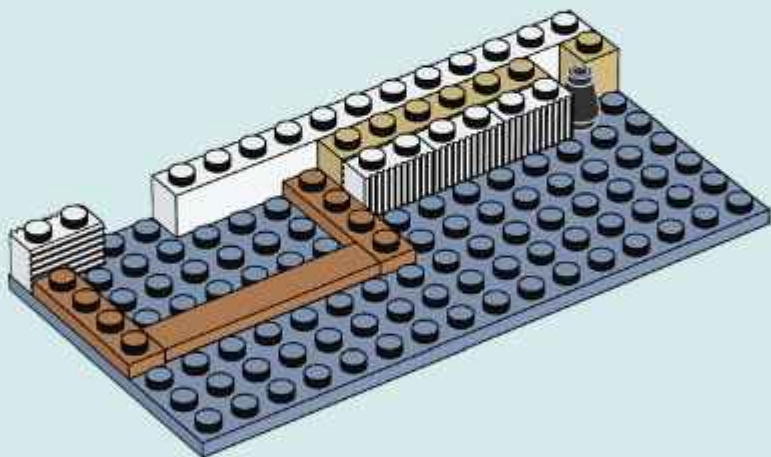



1x



2x

6

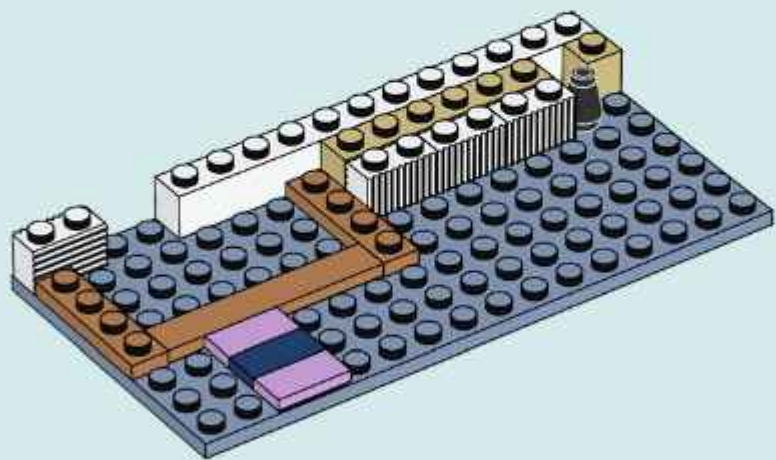



7

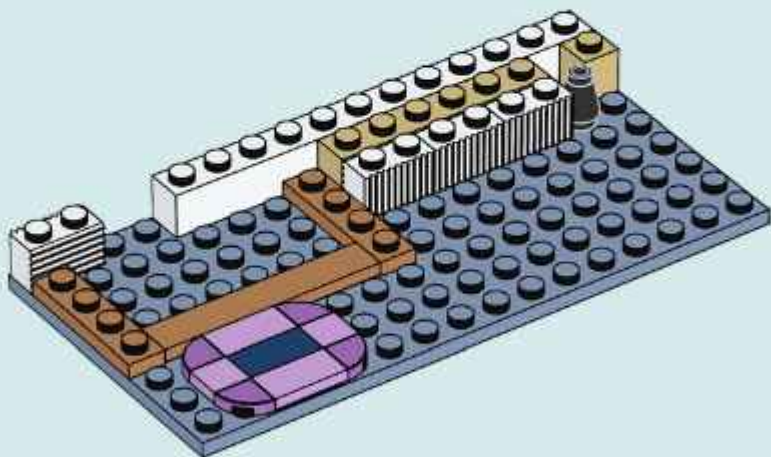



8

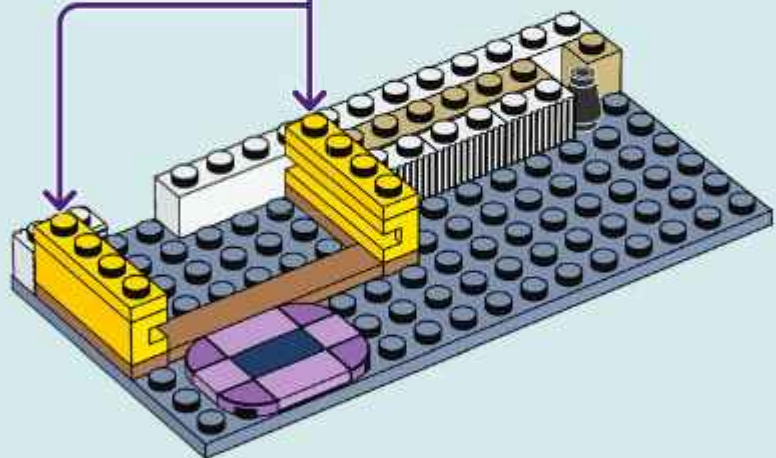
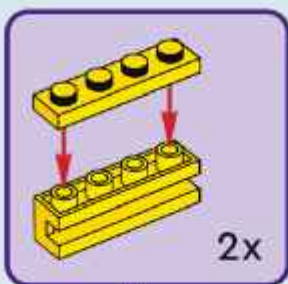

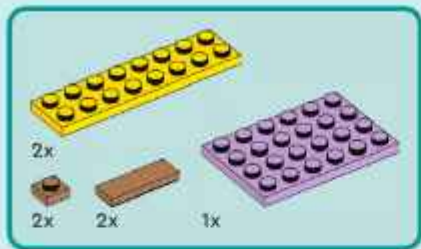

9

1

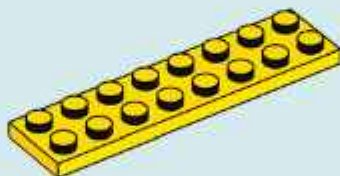

2

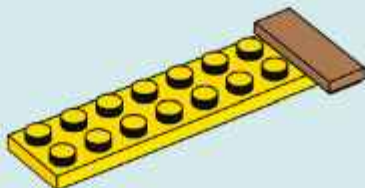

3

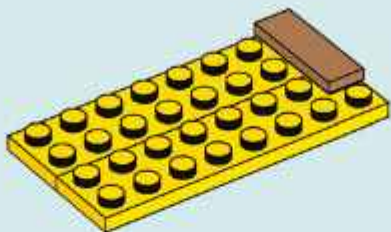

4

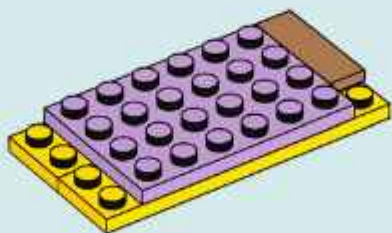

5

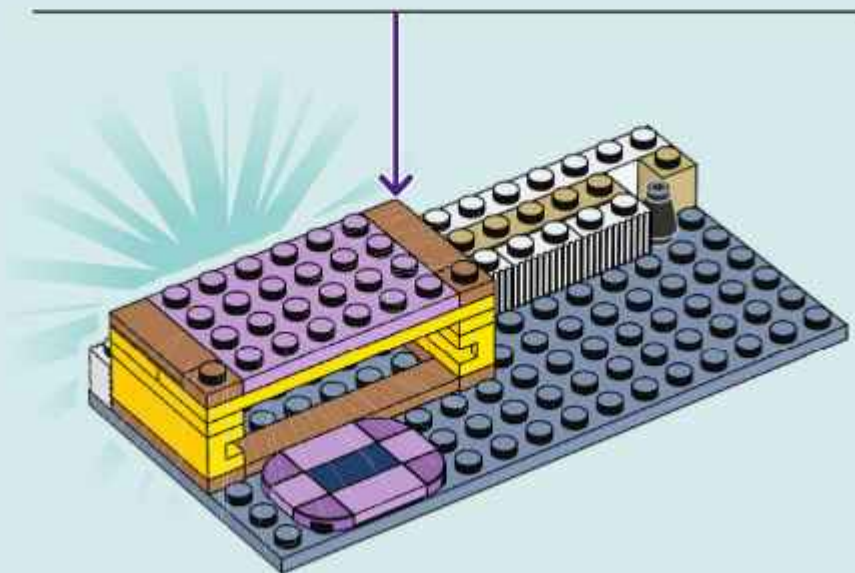
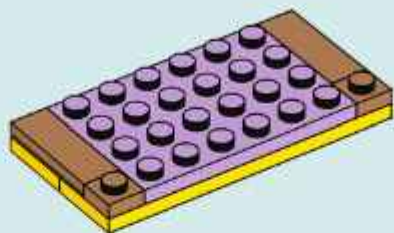



10

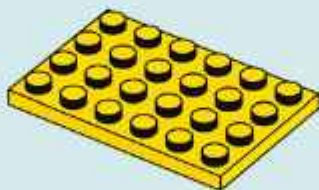



11

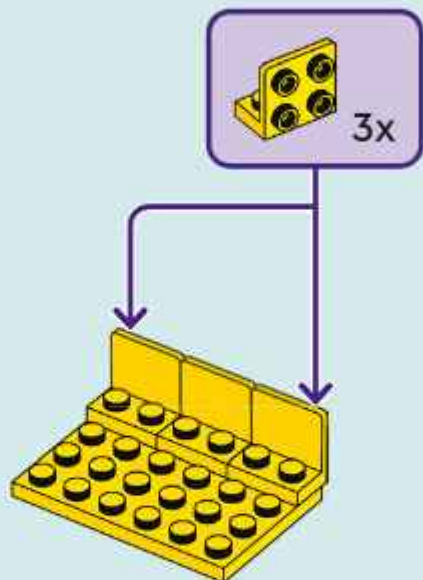



2x

12

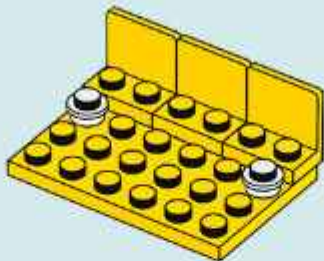

2x

13





1x



1x



1x

14





15

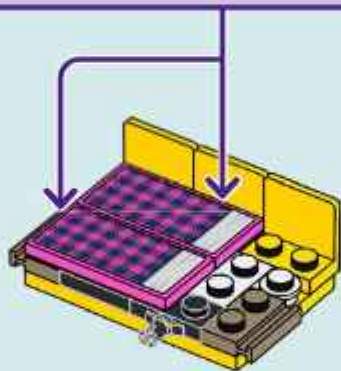
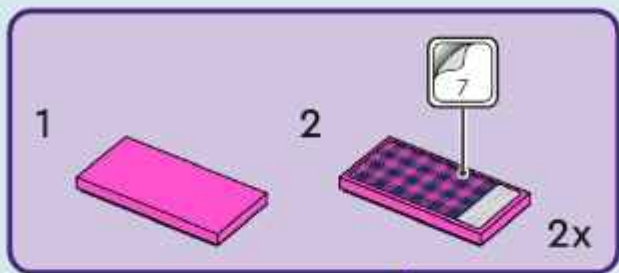

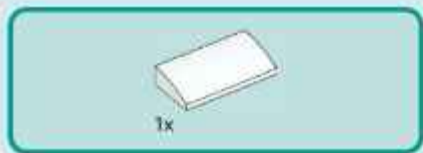

16

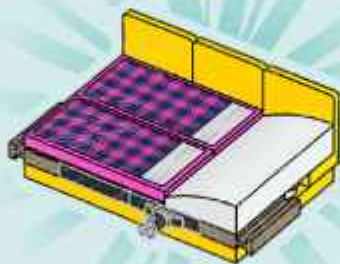

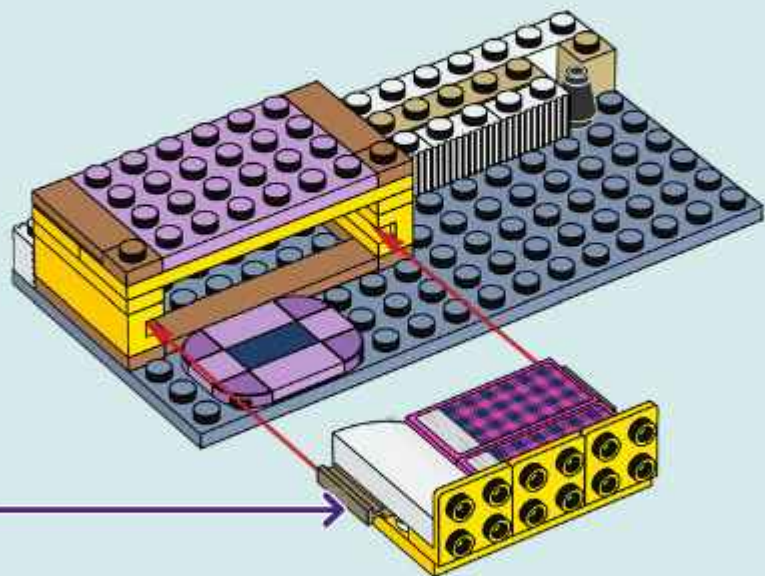



18

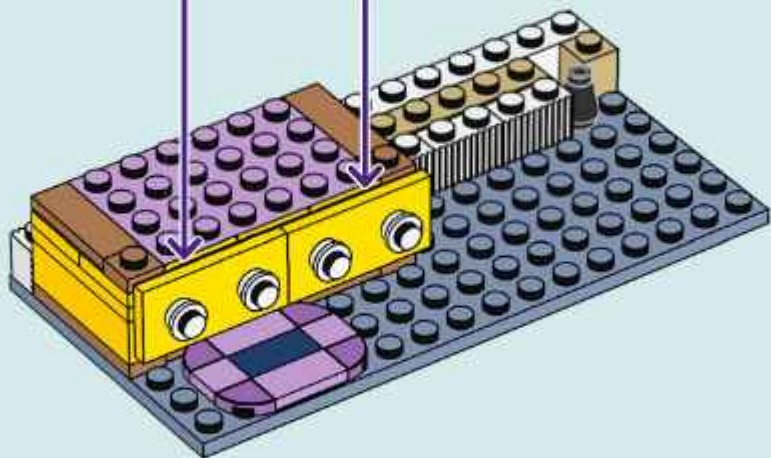
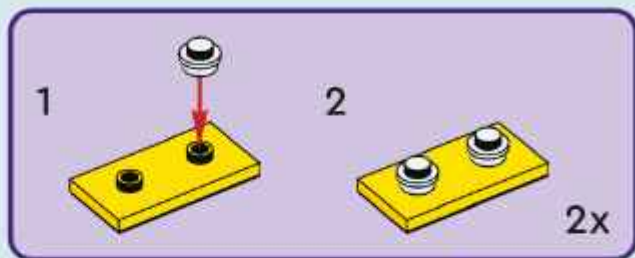



2x

19

1



2



2x

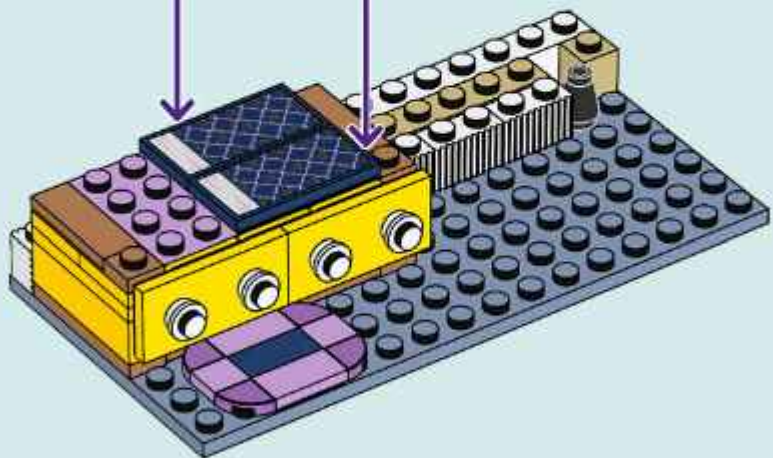

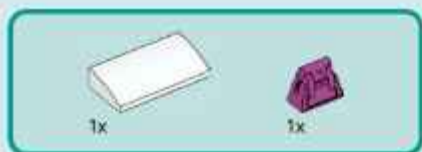

20

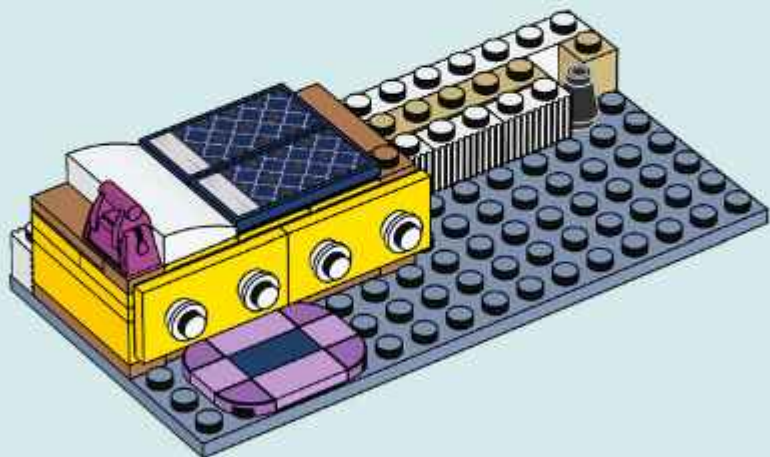



1x

21

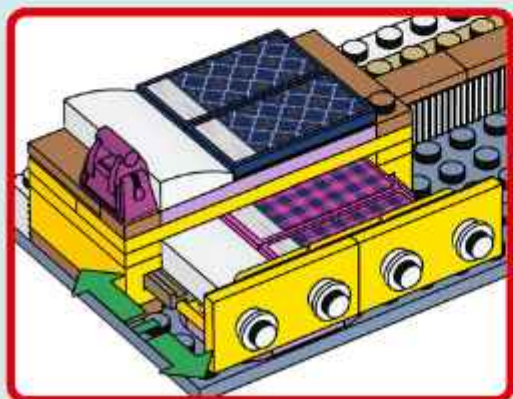
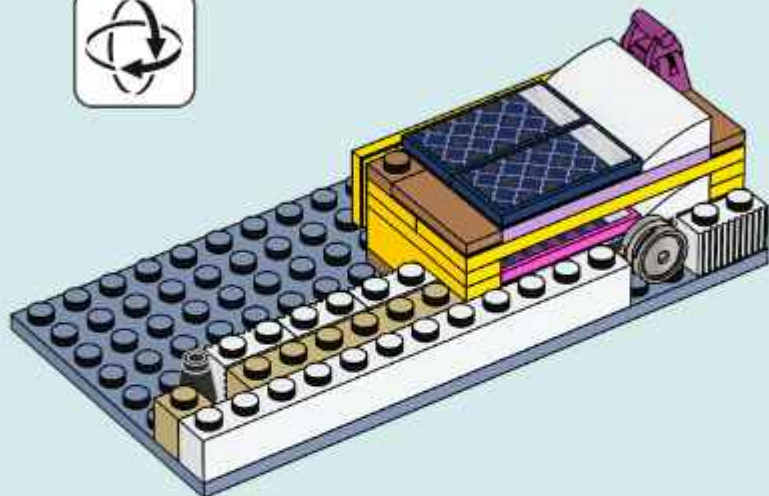



2x

22

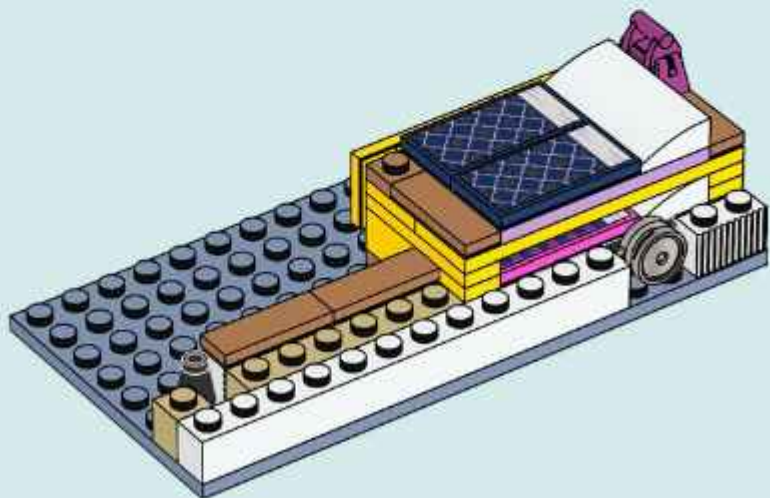



3x



1x

23

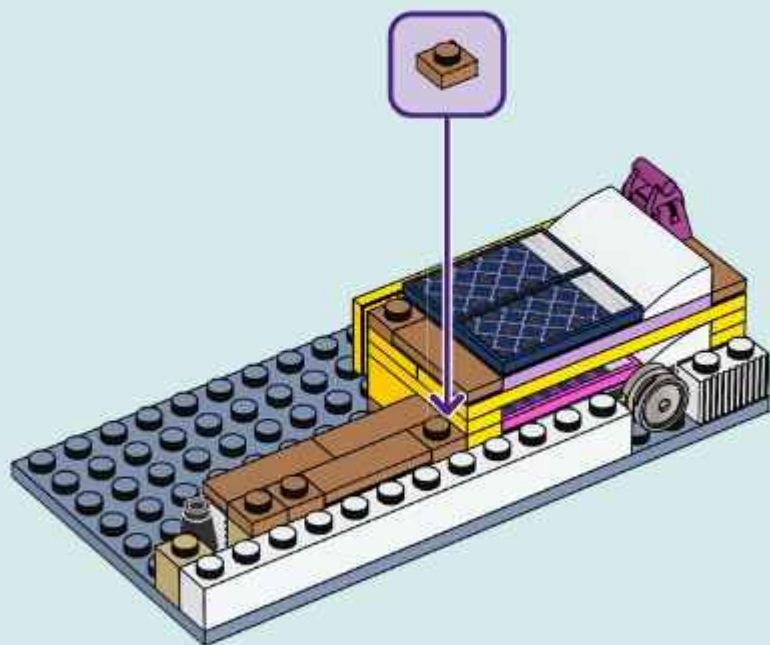

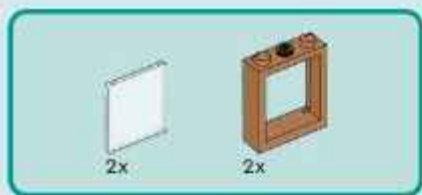

24

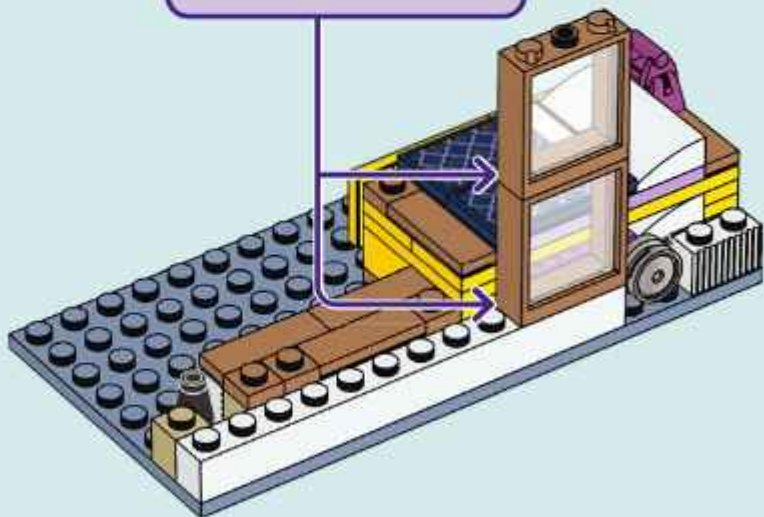
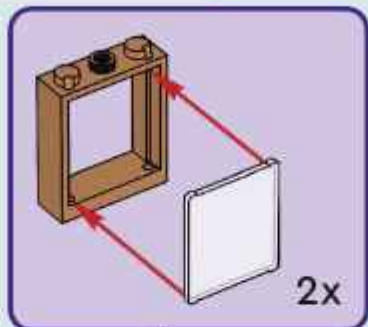

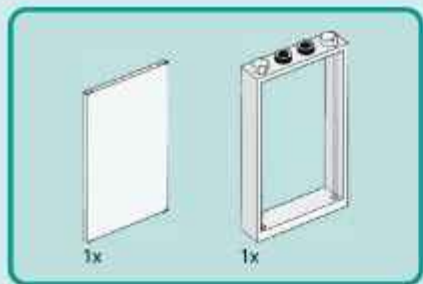

25

1

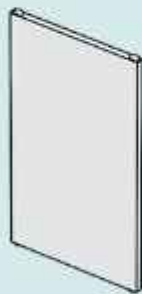

2



3

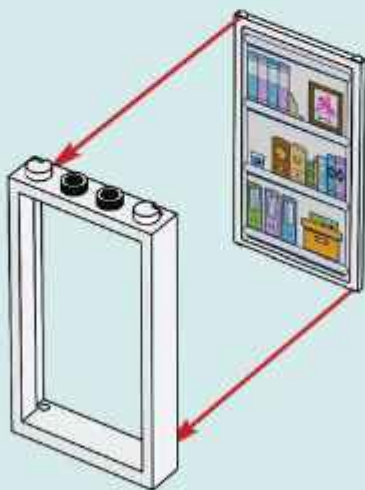

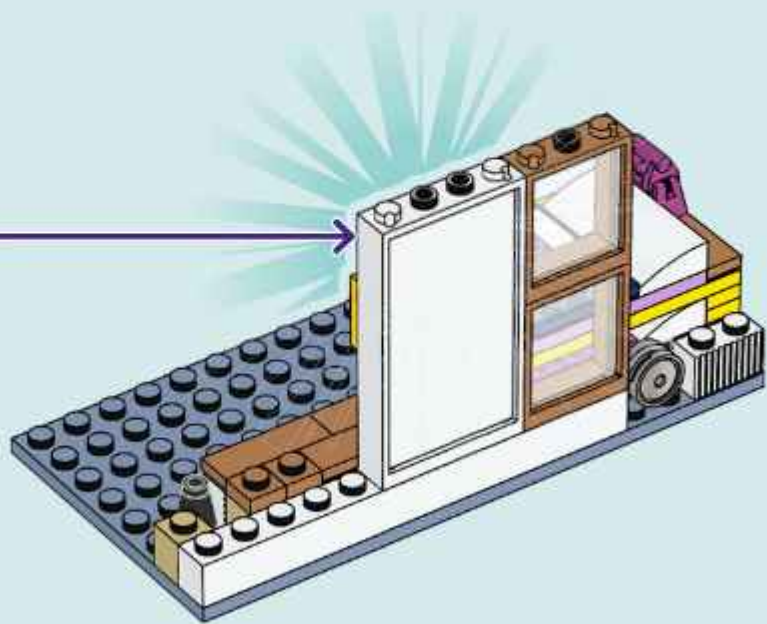

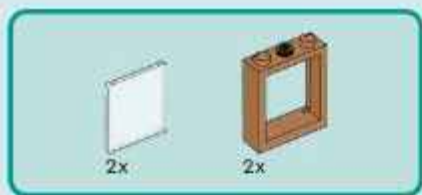

26

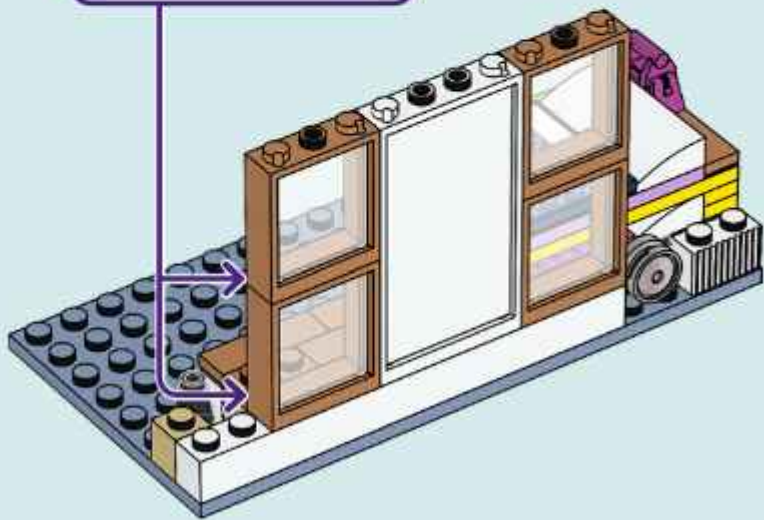
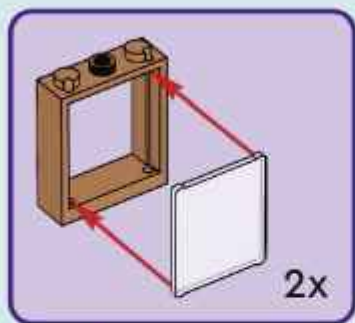



2x

27

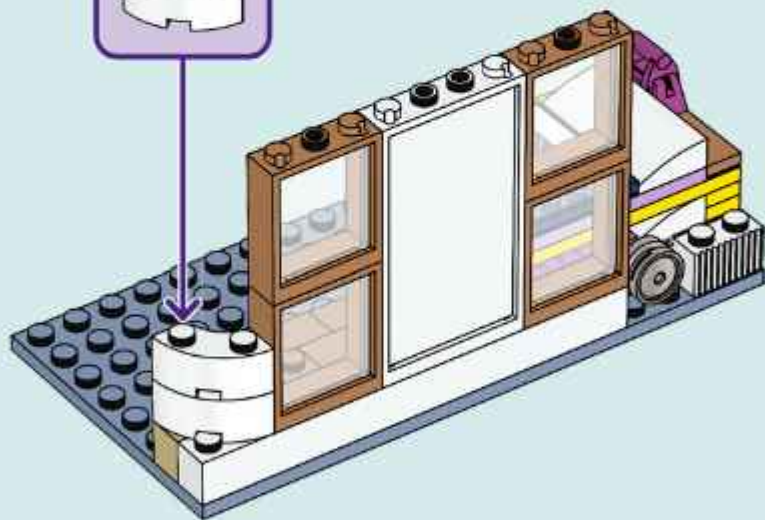
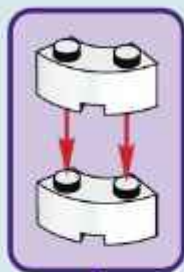

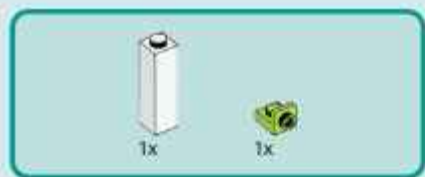

28

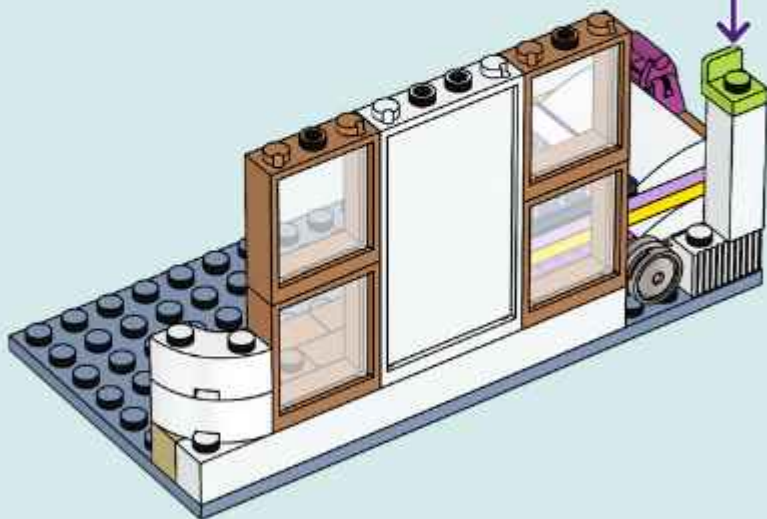
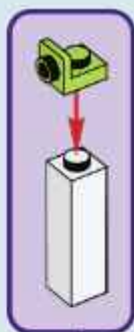

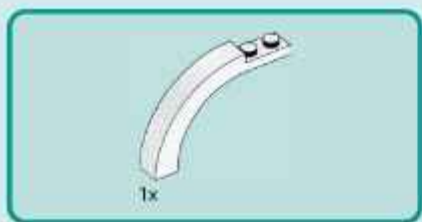

29

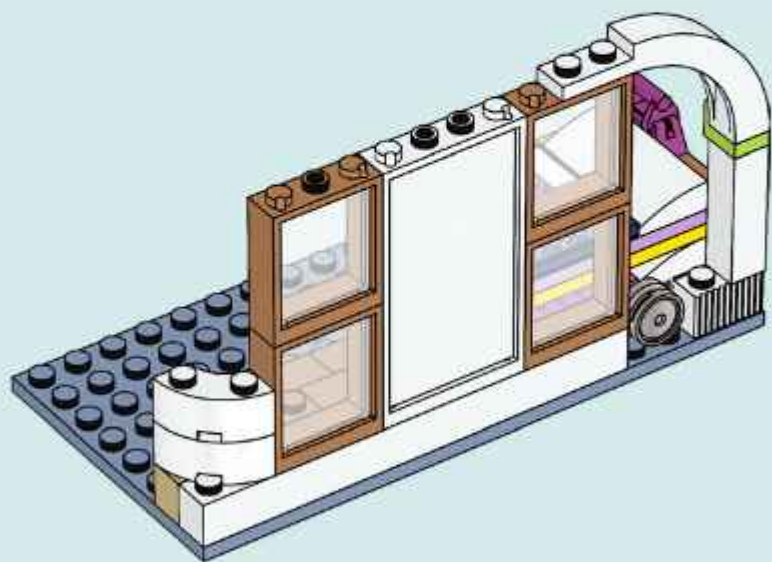



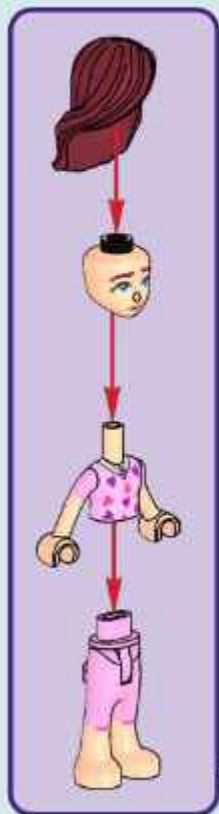

PAISLEY





1x



1x

30

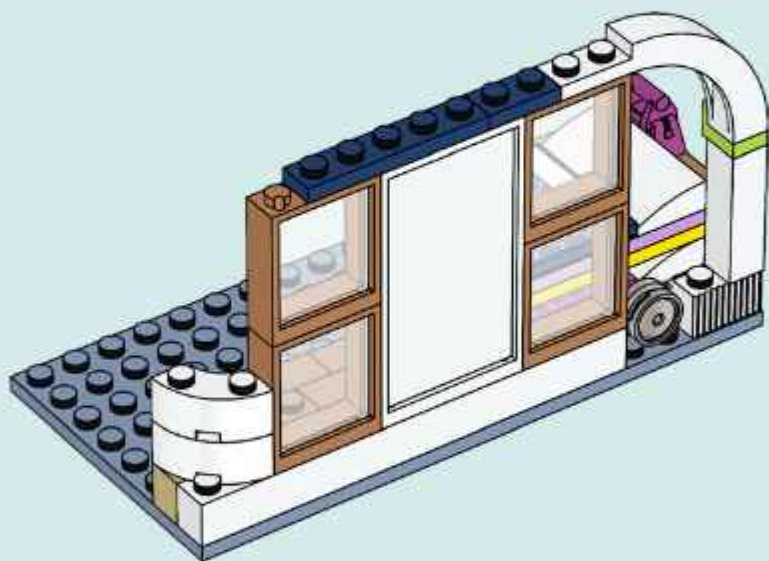



4X

31

1

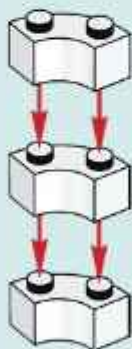

2

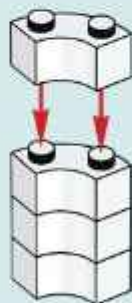

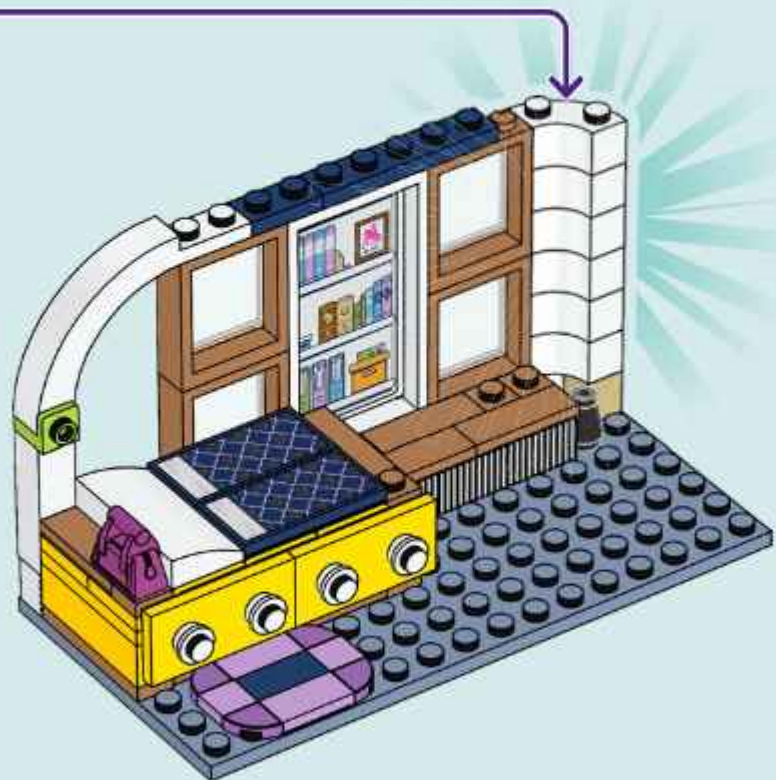



1x



1x

32





1x



1x

33





34

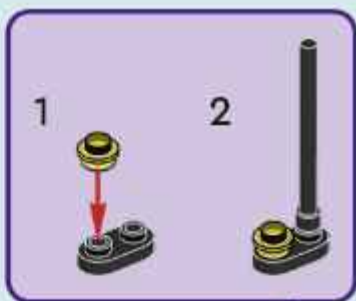



35

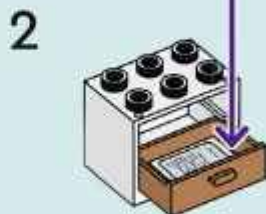
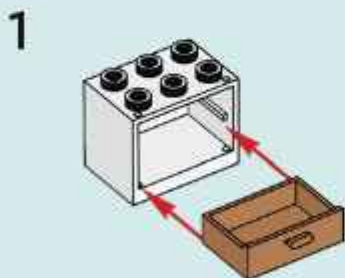
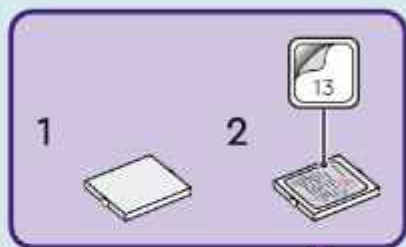

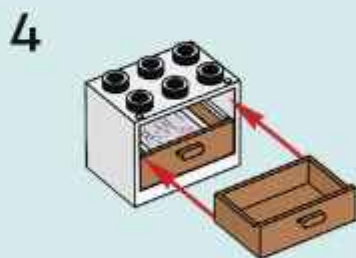
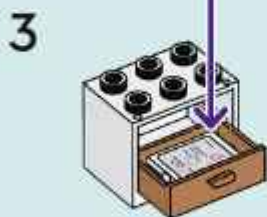
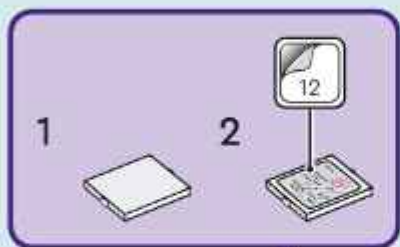

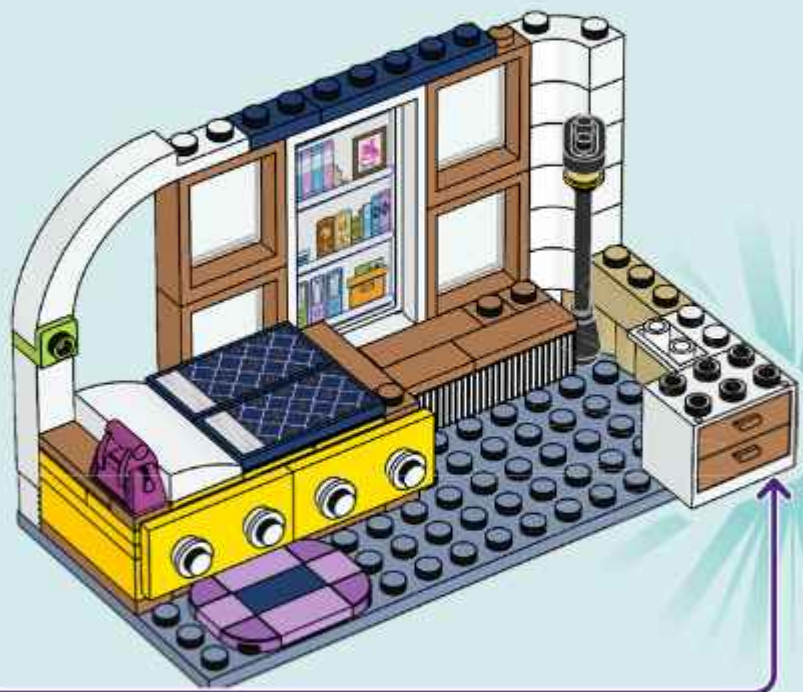



36



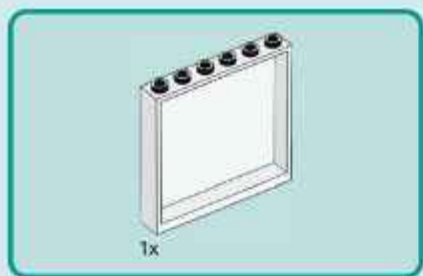

37

1



2



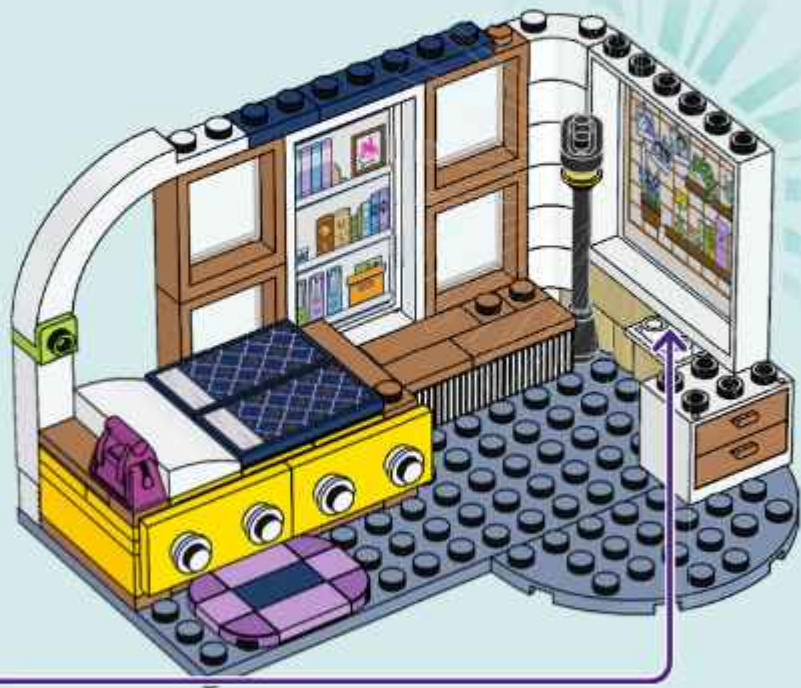



1x

38





2x

39



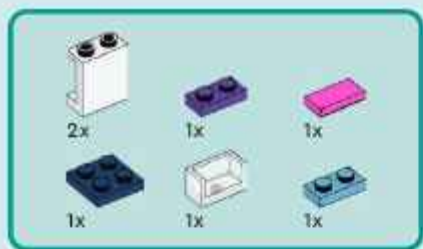

40

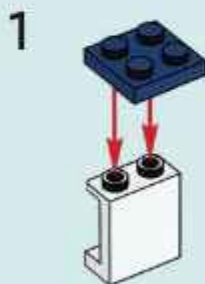

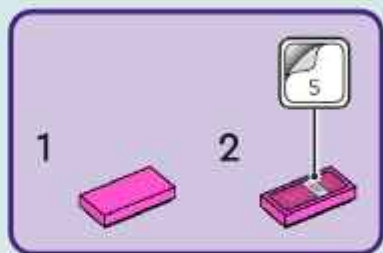
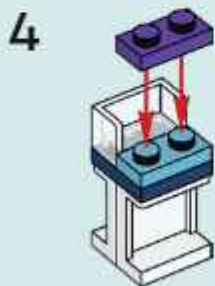

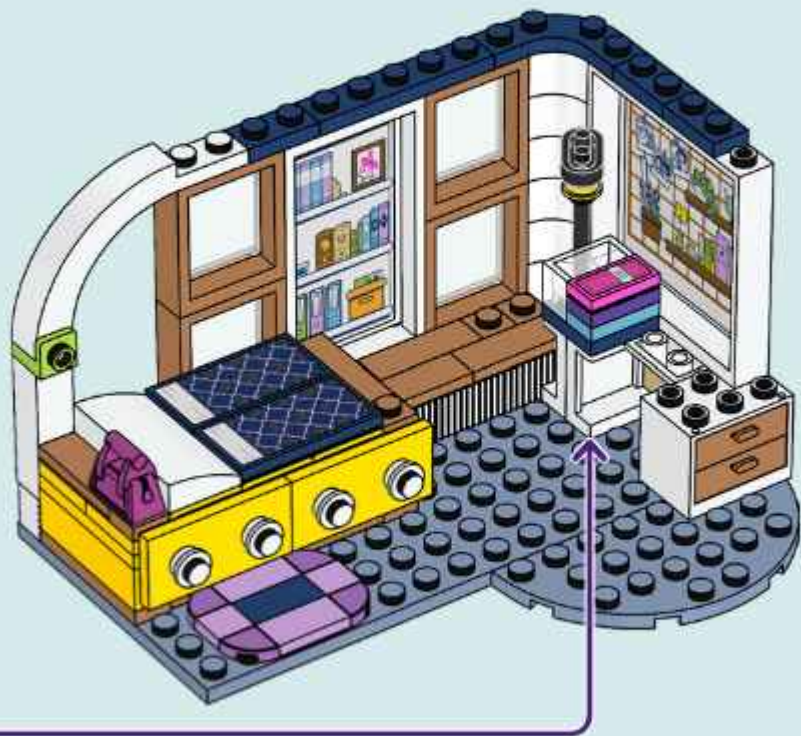



41





42





1x



1x

43

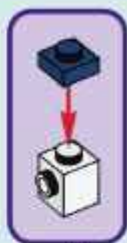



1x



1x

44

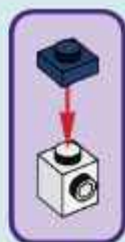



45

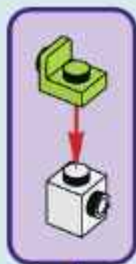



1x

46



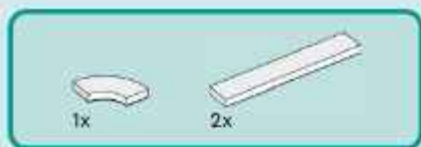

47





1x



1x



1x

48



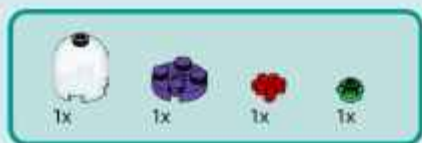

49

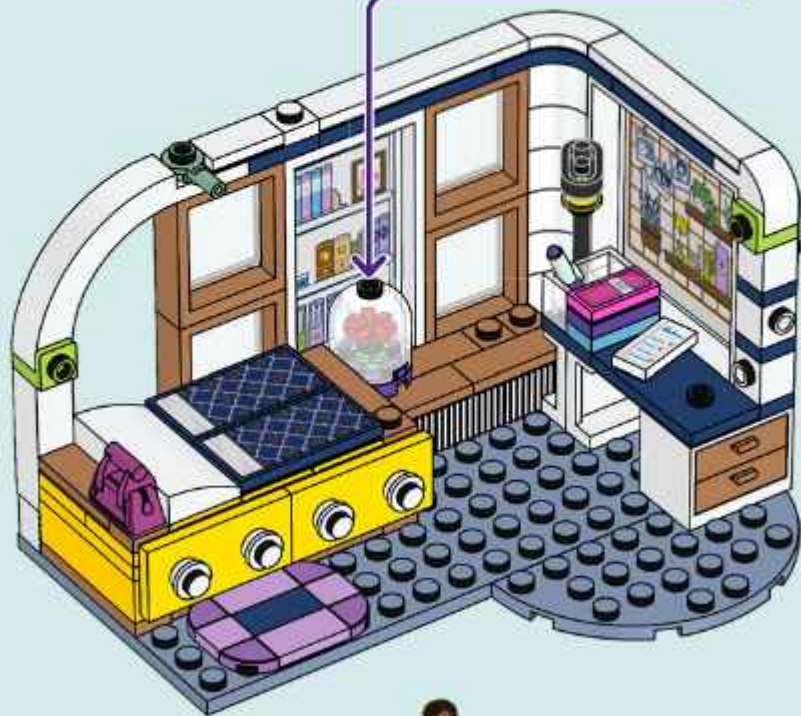
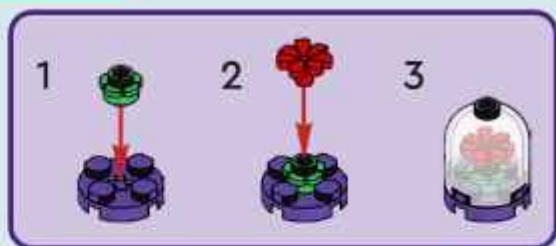

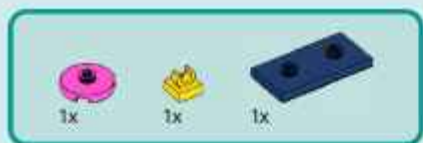

50





1x



1x

51

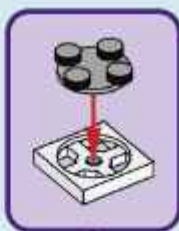



52

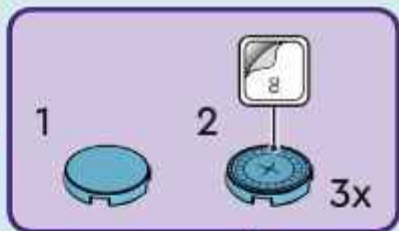



1x



1x



53





1x



1x



1x

54

1



2





55

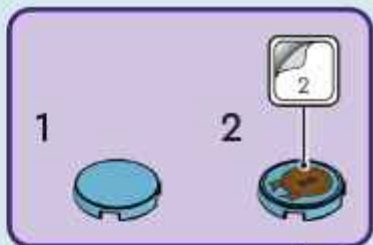



1x



1x

56



2x

57





2x

58



1x



1x

59

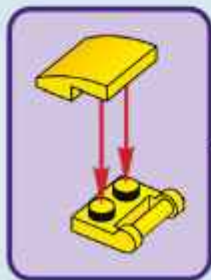

60





1x



1x



61





2x



2x

62



2x





63





64

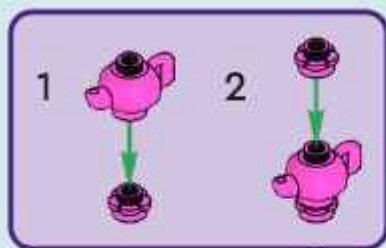

1



2



3







1x



1x



1x

65

1

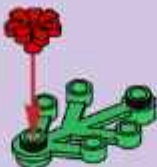

2





66

1



2



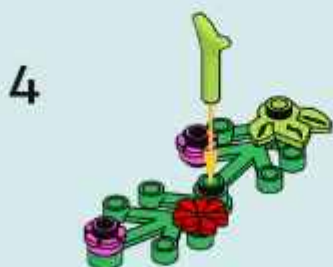
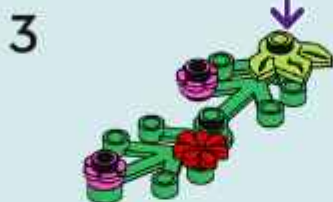
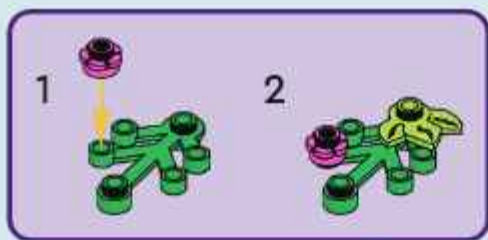







Friends



LEGO

Friends

PAISLEY

AUTUMN

ALIYA

ZAC





LEO

LTANN

OLLY

NOVA

LEGO

Friends

41731



41728



41743



6x
614101

1x
623401

3x
4558952

1x
802401

1x
6050541

1x
6253658

6x
4567449

2x
6256077

1x
4600294

4x
287701

2x
4583458

1x
506901

1x
6285777

1x
6329599

1x
6157985

2x
6347304

1x
6366391

1x
568001

1x
6172674

1x
502205

1x
6256050

1x
6223667

1x
4619665

1x
4588208

1x
6262963

2x
4583297

2x
663601

1x
6185956

1x
4504228

1x
611205

1x
4113915

1x
4218749

2x
4162465

1x
4112982

5x
6182260

1x
6348036

2x
6146219

3x
6208753

1x
4501232

1x
6079007

2x
6057457

2x
571034

2x
6424448

1x
303224

2x
303424



1x
8170421



1x
4529236



1x
6210270



1x
6370669



1x
302126



1x
6306748



1x
6286876



1x
6273152



1x
6248909



4x
6278710



4x
4616771



1x
6329699



1x
4177932



1x
6135287



3x
6268814



2x
6557616



1x
6540333



1x
6500724



1x
6395609



1x
6416663



1x
6428467



1x
6424469



1x
6424447



1x
4568637



1x
4540203



1x
4244627



1x
6257044



1x
6240225



1x
6240218



1x
6609769



2x
6365620



1x
6258352



1x
6258353



6x
6286831



1x
6420268



1x
6616470



1x
6382577



1x
6101858

3x
4184108

3x
4528981

3x
4528488

1x
6037890

1x
6367984

2x
6357956

2x
4569836

1x
6384973

3x
6209679

1x
6135667

2x
6223767

1x
6056381

2x
6056261

1x
6416612

1x
6416464

2x
6347297

2x
6030334

2x
4655695

1x
6141922

1x
6416490

1x
6429226

1x
6186672

1x
6173119

1x
6173109

1x
6409768

1x
6287854

5x
6215606

5x
6365746

4x
6422086

2x
6126118

2x
6167700

1x
6102995

1x
4624473

4x
0143253

1x
6097619

1x
6213681

4x
6199893

2x
6211603

2x
6345796

1x
6334050

 [LEGO.com/service](https://www.LEGO.com/service)



YOU COULD

WIN



Scan this QR code or go to
LEGO.COM/PRODUCTFEEDBACK
and give us your short feedback
about this LEGO® set for a chance
to win a cool LEGO prize.

Terms and Conditions apply*

DE: Du könntest GEWINNEN. Es gelten die Teilnahmebedingungen* **FR: Tu pourrais GAGNER.** Des conditions s'appliquent* **IT: Potresti VINCERE tu.** Termini e condizioni sono applicabili* **ES: Puedes GANAR.** Aplican términos y condiciones* **PT: Poderá GANHAR.** Aplicam-se termos e condições* **JÁ: プレゼント付き! 利用規約が適用されます*** **ZH: 轻松获奖. 条款和条件适用*** **KO: 상품의 주인이 되어보세요. 소정의 약관이 적용됩니다*** **RU: Вы можете ВЫИГРАТЬ.** Действуют положения и условия* **PL: Szansa na WYGRANĄ.** Obowiązują warunki korzystania* **CS: Máte šanci VYHRÁT.** Platí všeobecné smluvní podmínky* **SK: Máte šancu VYHRÁŤ.** Platia všeobecné zmluvné podmienky* **HU: TE IS NYERHETSZ.** Felhasználási feltételek érvényesek* **RO: Ai putea CÂȘTIGA.** Se aplică termenii și condiții* **BG: Можете да СПЕЧЕЛИТЕ.** Има определени правила и условия* **LV: Tu vari LAIMĒT.** Ir spēkā noteikumi un nosacījumi.* **ET: Sul on võimalus VÕITA.** Kehtivad tingimused* **LT: Jūs galite LAIMĖTI.** Taikomos sąlygos*

*[LEGO.com/productfeedback-terms](https://www.lego.com/productfeedback-terms)

LEGO, the LEGO logo and the FRIENDS logo are trademarks of the/son des marques de commerce du/son marcas registradas de LEGO Group. ©2023 The LEGO Group. All rights reserved./Tous droits réservés./Todos los derechos reservados.