



# Harry Potter



76409





[LEGO.com/sustainable-packaging](https://LEGO.com/sustainable-packaging)



# BUILDER



Apple and the Apple logo are trademarks of Apple Inc., registered in the U.S. and other countries and regions. App Store is a service mark of Apple Inc. Google Play and the Google Play logo are trademarks of Google LLC. Tencent and the Tencent logo are trademarks of Tencent Inc.

Q [LEGO.com/devicecheck](https://www.lego.com/devicecheck)

**EN** Ask parents' permission before going online | **DE** Eltern um Erlaubnis bitten, bevor du online gehst | **FR** Demande l'autorisation d'un parent avant d'aller en ligne | **IT** Chiedi il permesso ai tuoi genitori prima di andare online | **ES** Pídeles permiso a tus papás antes de conectarte a Internet | **PT** Peça autorização aos pais antes de acederes online | **JA** オンラインになる前にほご者の方のきよかもをもらおう | **ZH** 上网前应先征得父母的同意 | **KO** 온라인 접속 전에 보호자 동의가 필요합니다 | **RU** Спроси разрешения у родителей, прежде чем заходить в интернет | **PL** Poproś rodziców o zgodę, zanim wejdiesz do Internetu | **CS** Než půjdeš na internet, požádej rodiče o svolení | **SK** Skôr než pôjdeš na internet, vypýtaj si povolenie od rodičov | **HU** Kérj szülői engedélyt, mielőtt online csatlakoznál! | **RO** Cere permisiunea părinților înainte de a te conecta online | **BG** Поискайте разрешение от родител, преди да влезете онлайн | **LV** Pirms došanās tiešsaistē palūdz atļauju vecākiem | **ET** Enne Interneti kasutamist küsi vanematelt luba | **LT** Prieš prisijungdami prie interneto, atsiklauskite tėvų

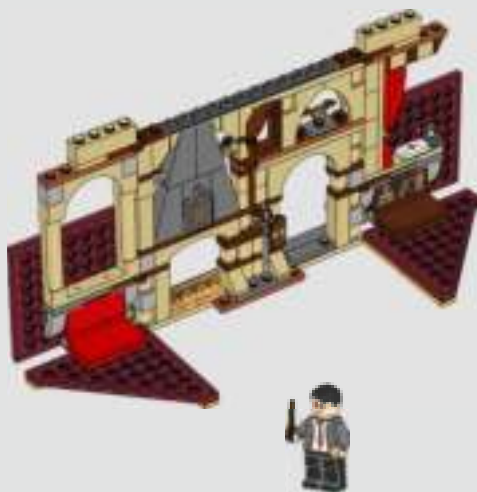

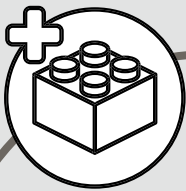

2x

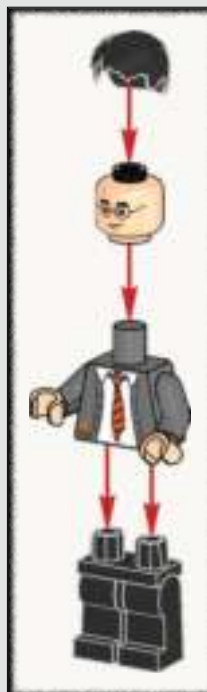

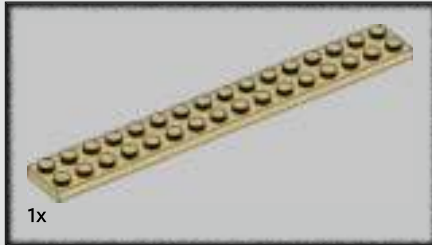

1

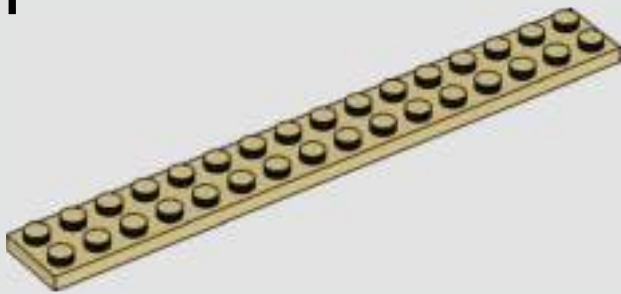

6

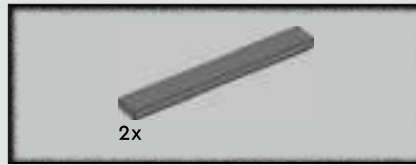

2

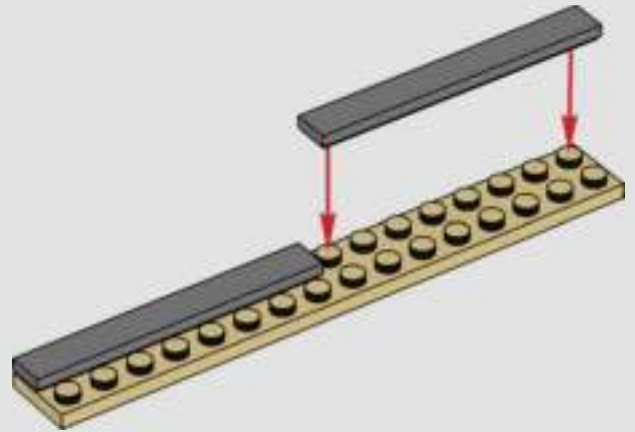



3

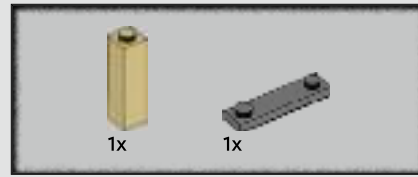
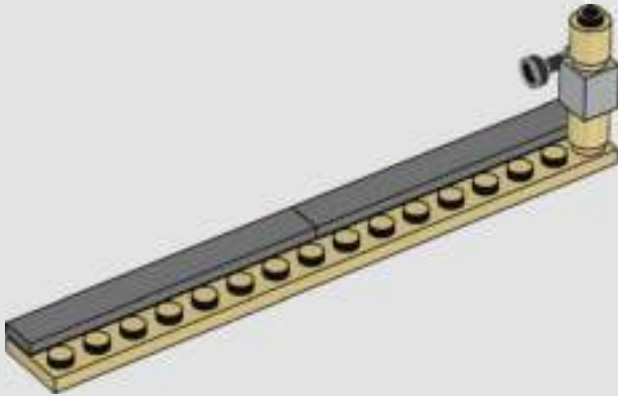
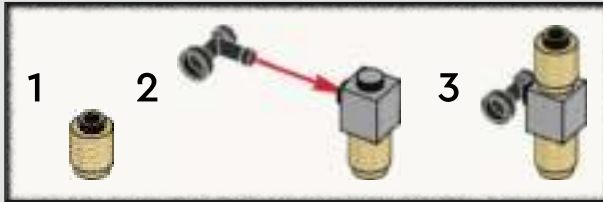

4

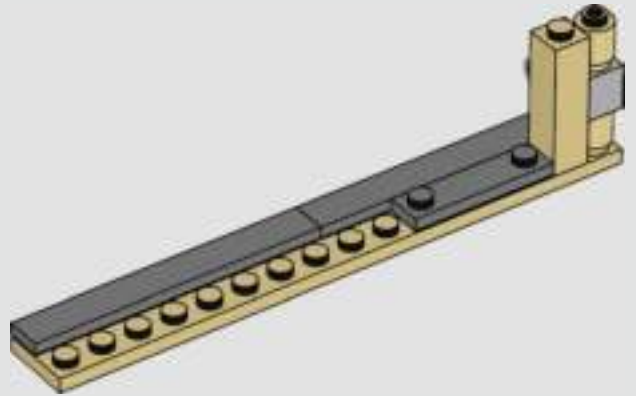



5

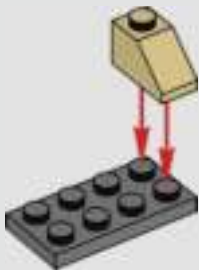

6

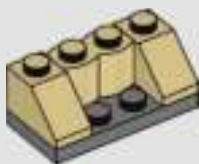

7



8

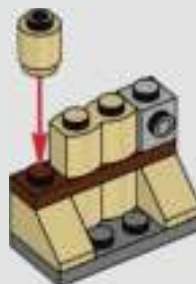





9

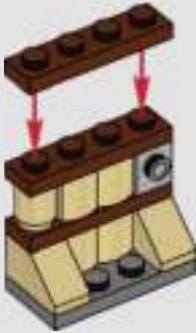

10



11



12

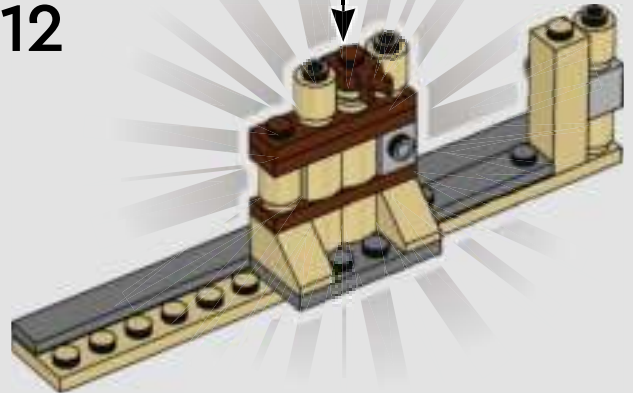

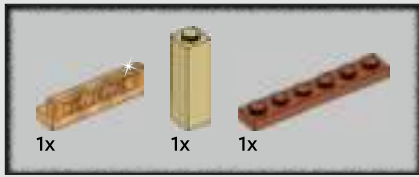

13

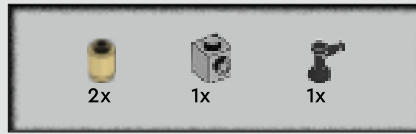
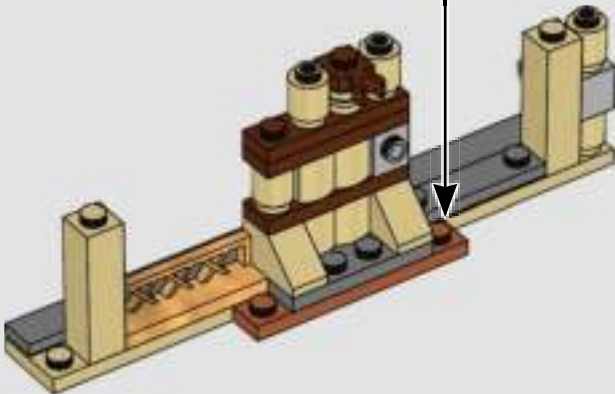
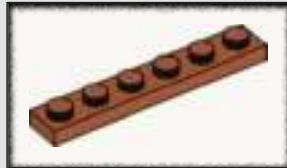

14

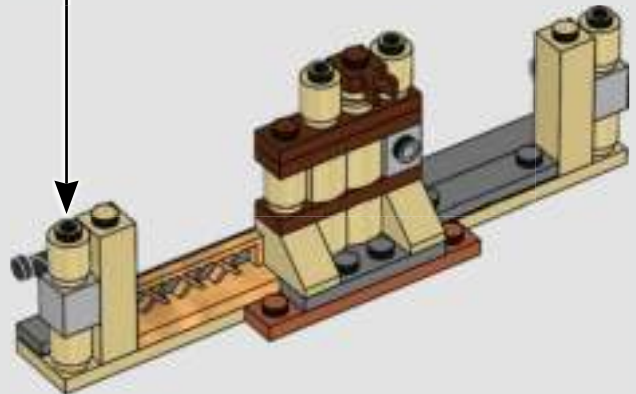
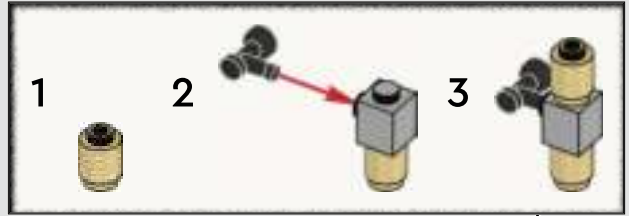

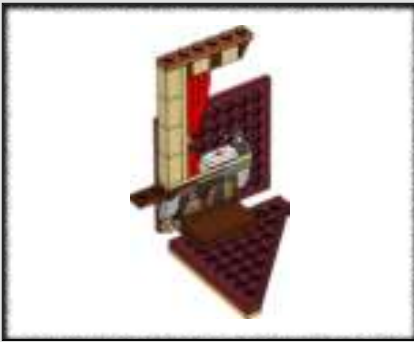

15



16



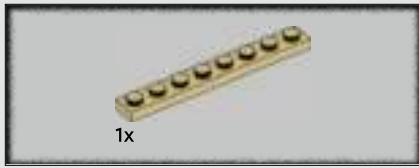

17

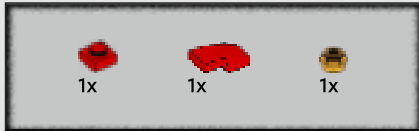
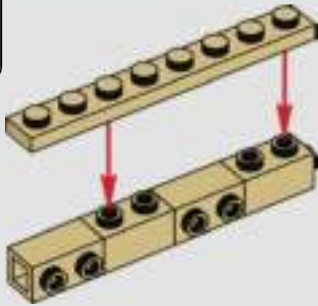

18

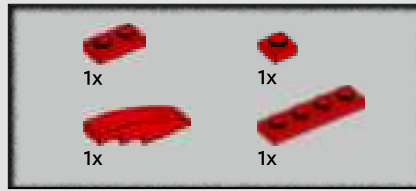

19

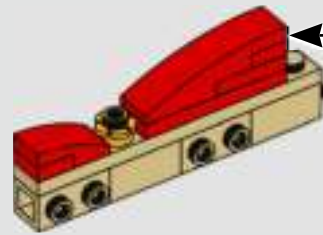
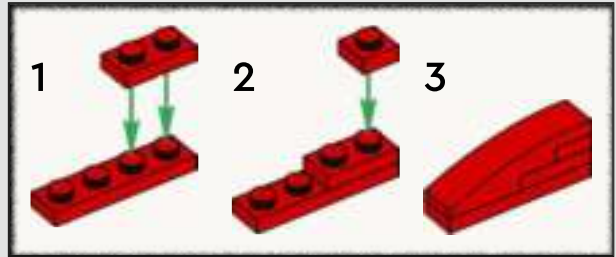

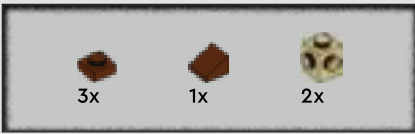

20

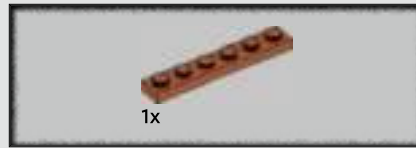
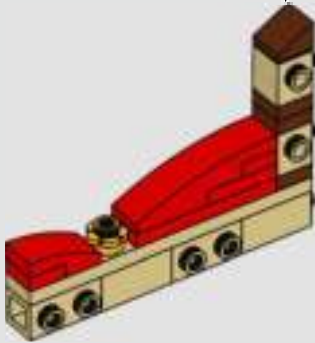
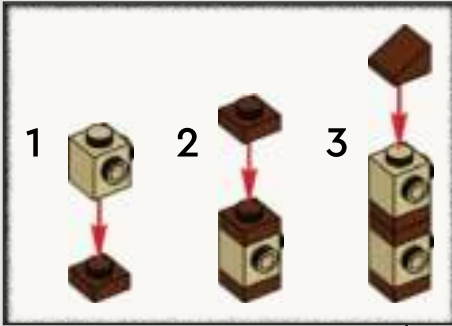

21

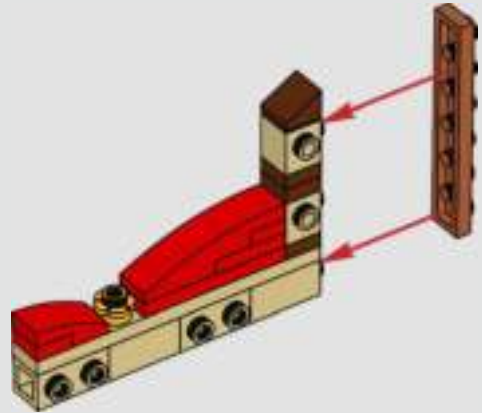

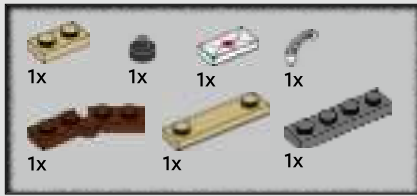

22

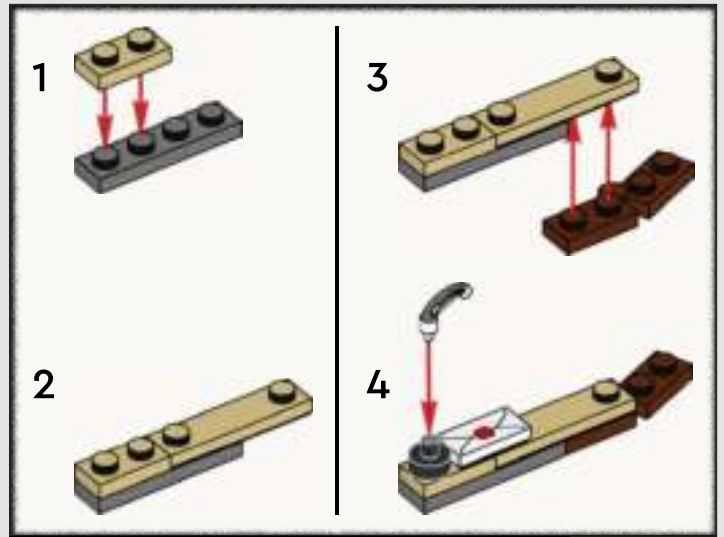



23

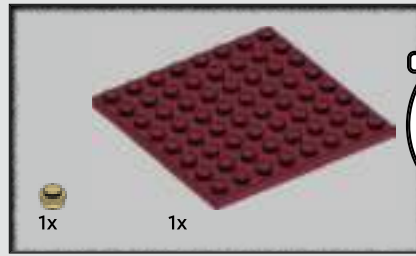
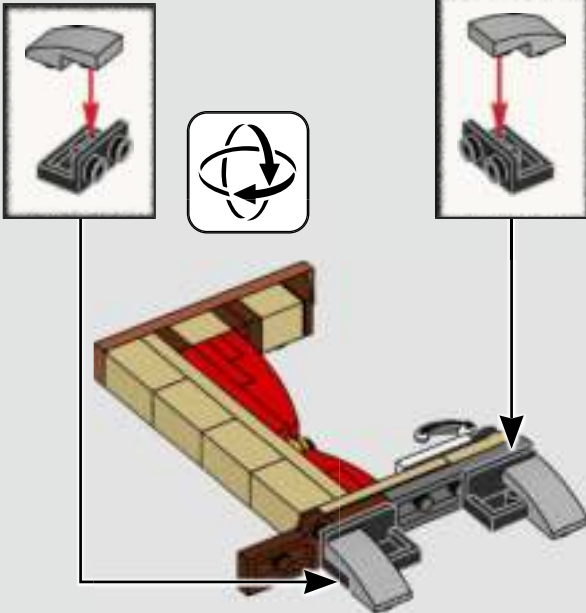

24

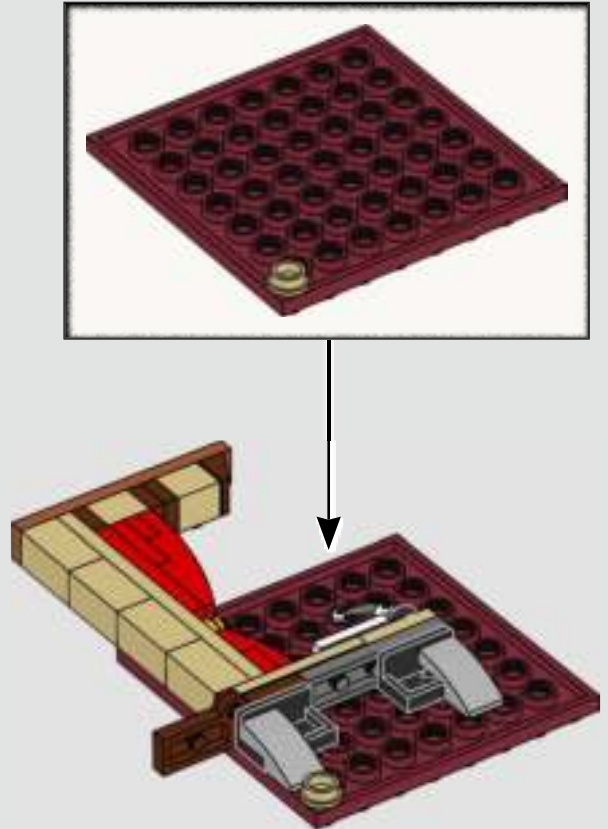



25

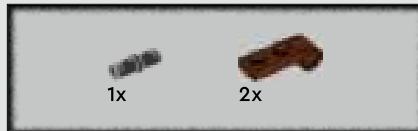
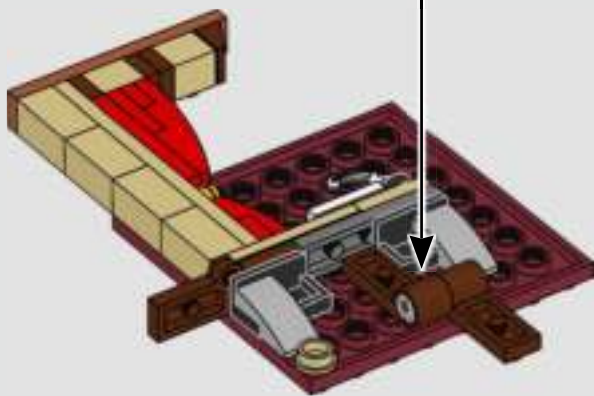
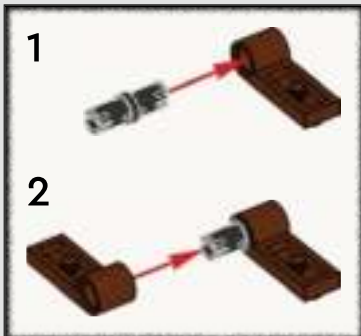

26

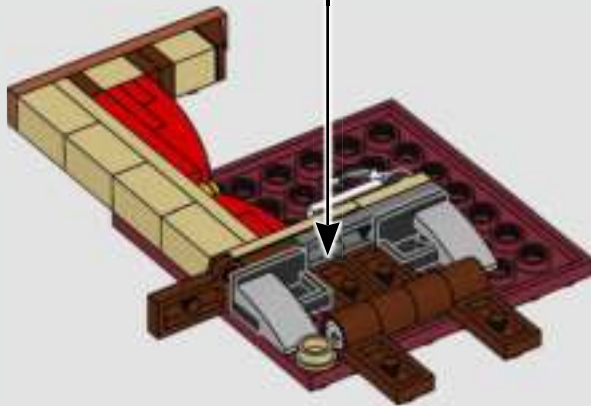
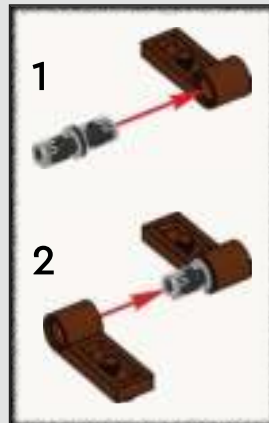





27

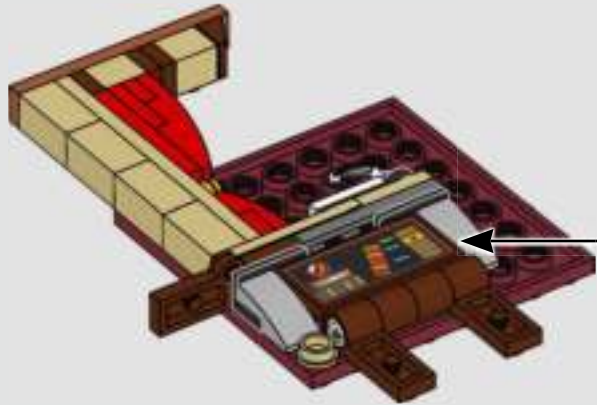

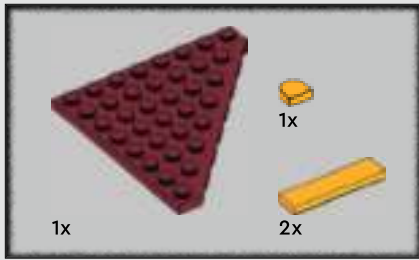

28

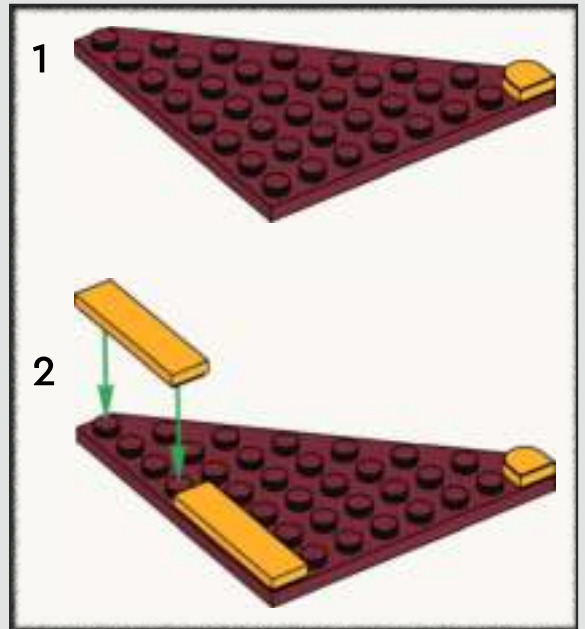
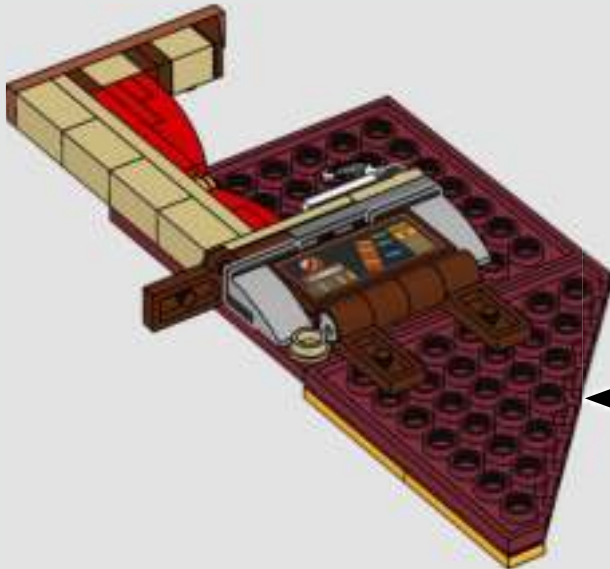



29

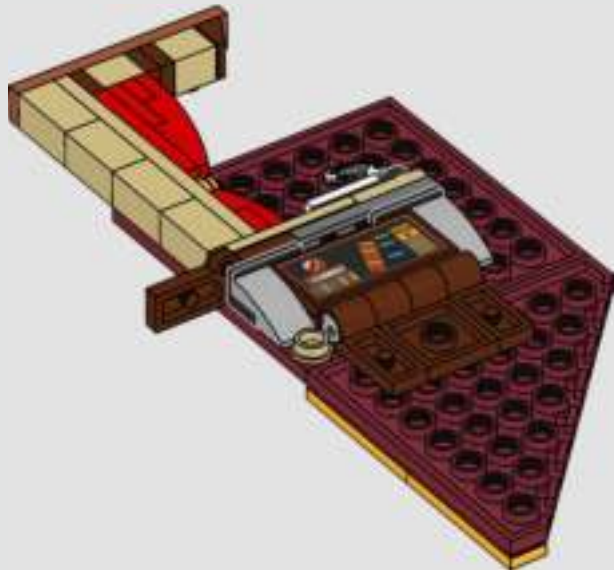

30





32

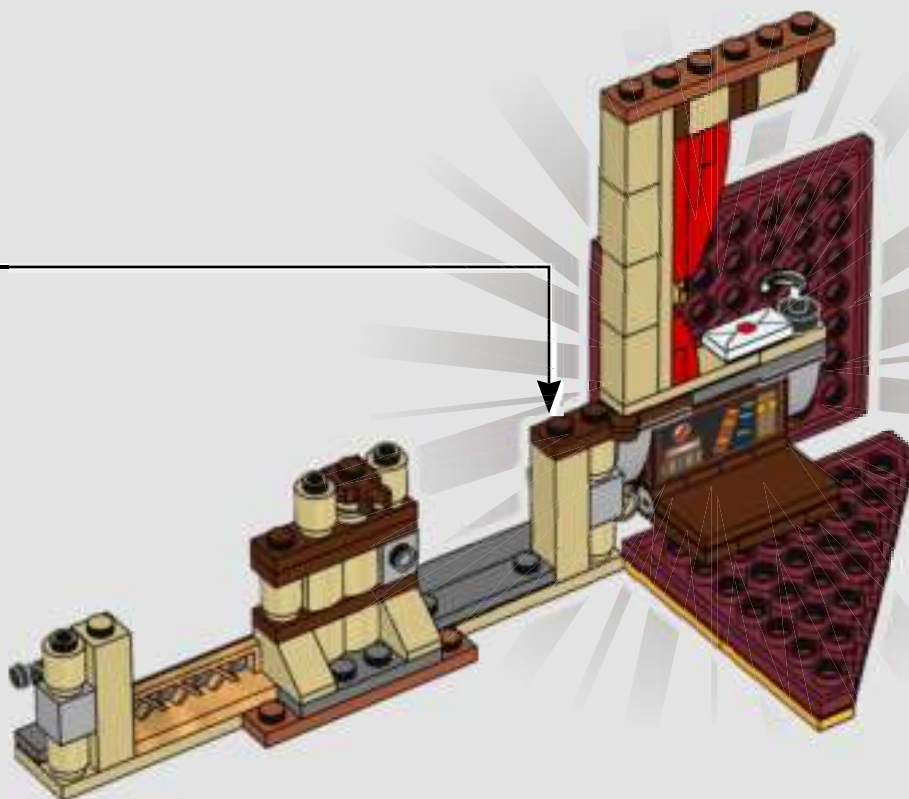

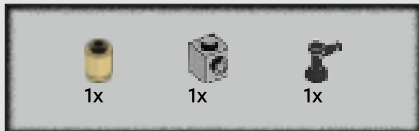

33

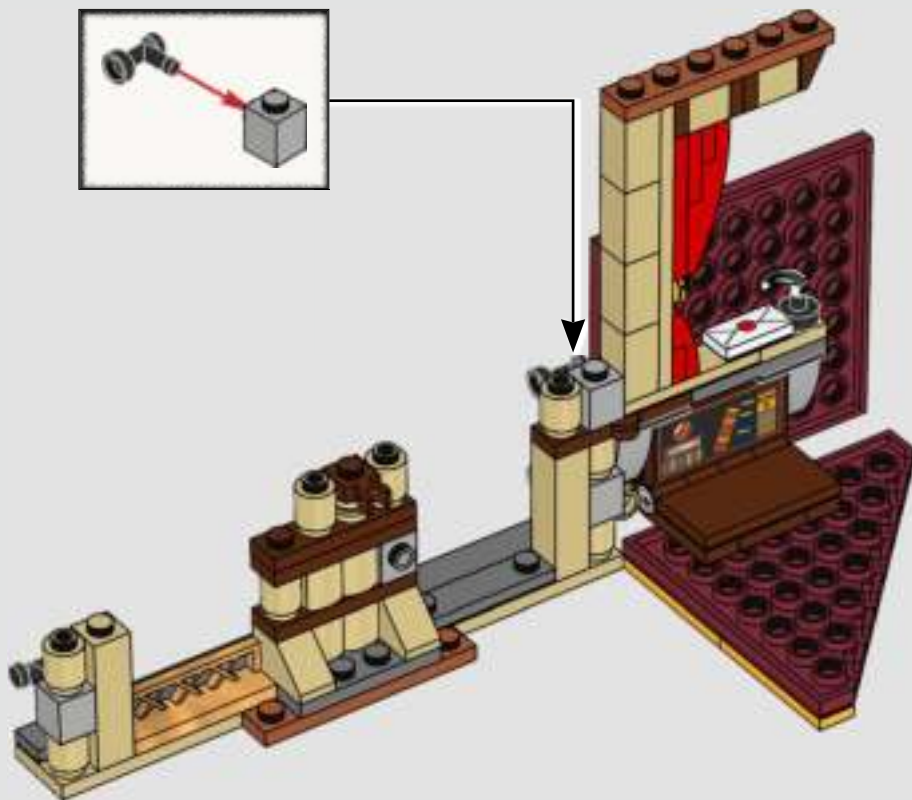

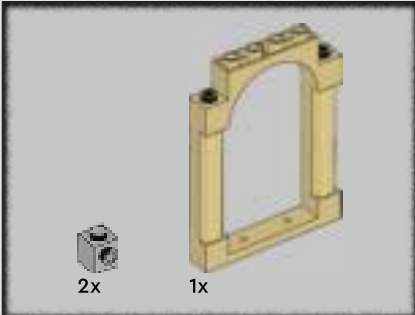
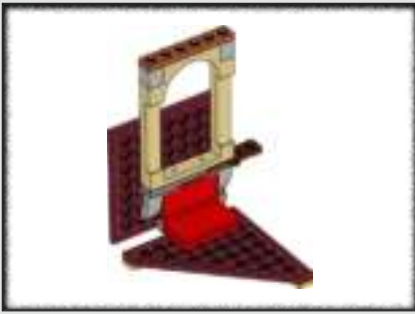

34

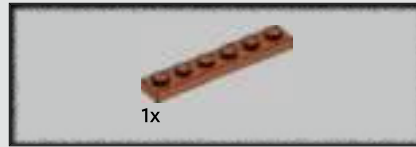
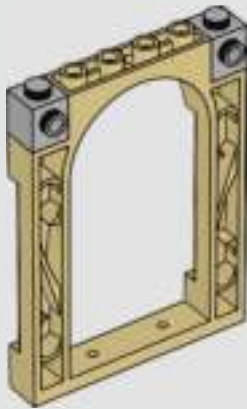

35

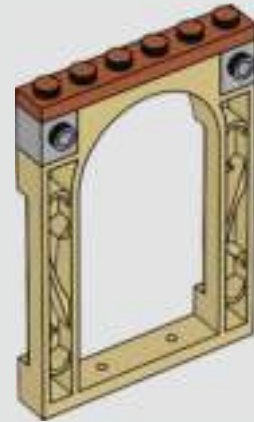

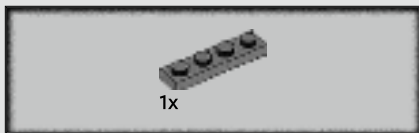

36

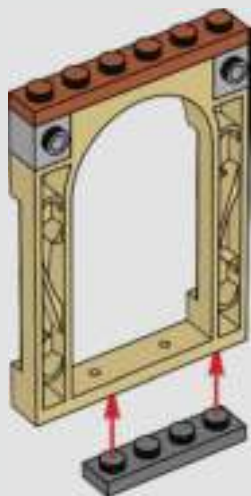

37

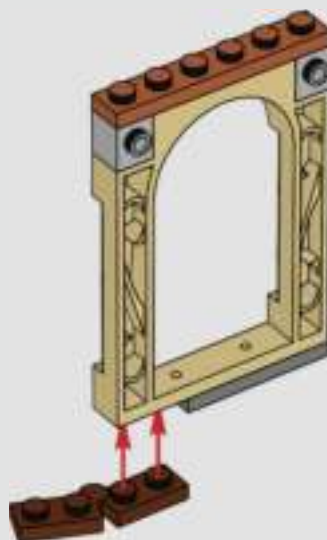





38

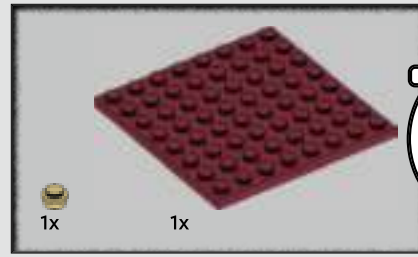
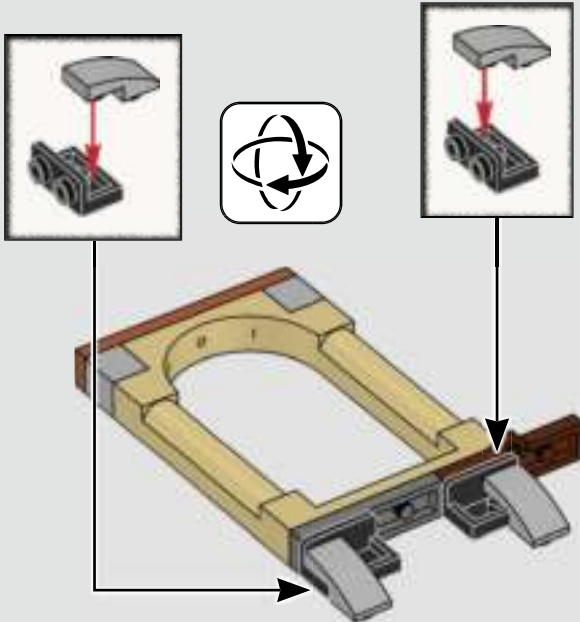

39

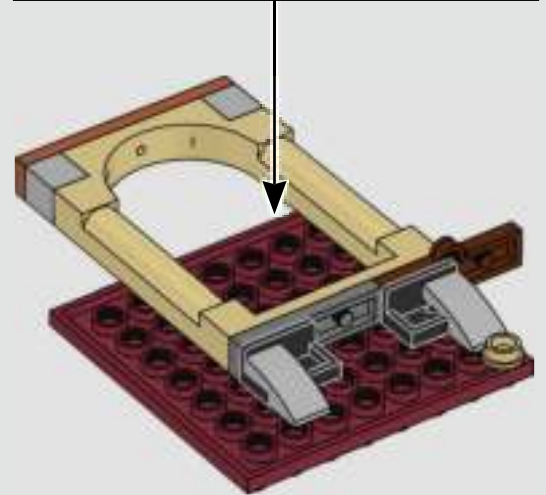
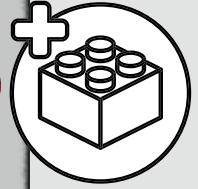

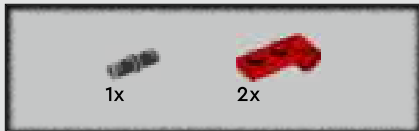

40

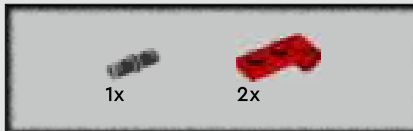
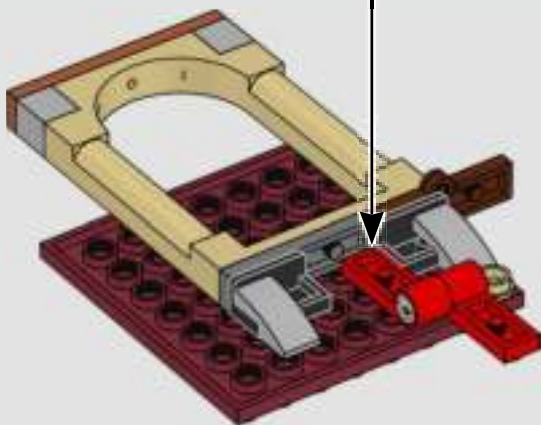
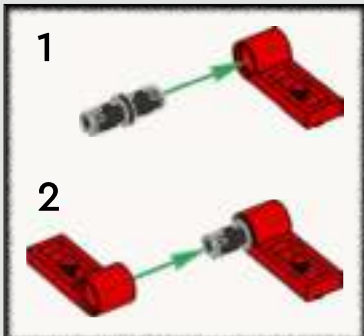

41

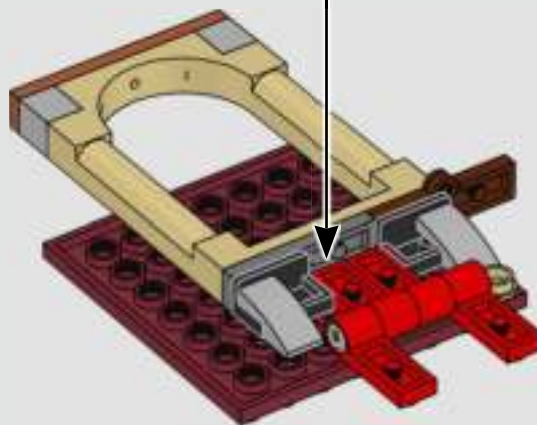
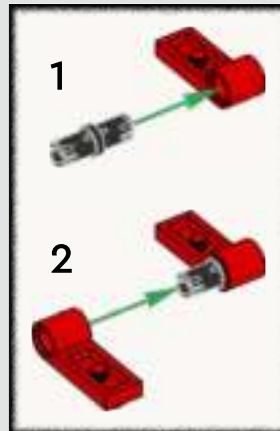

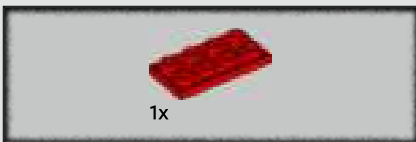

42

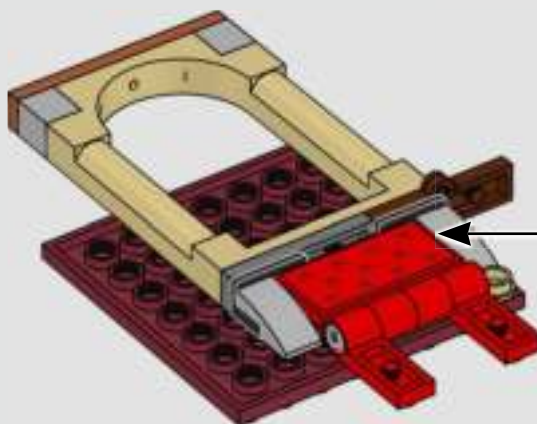
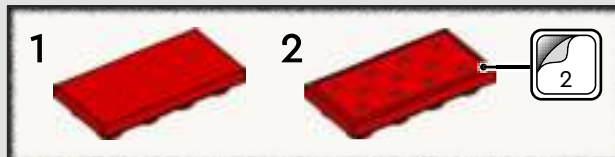

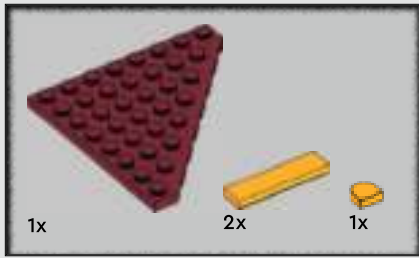

43

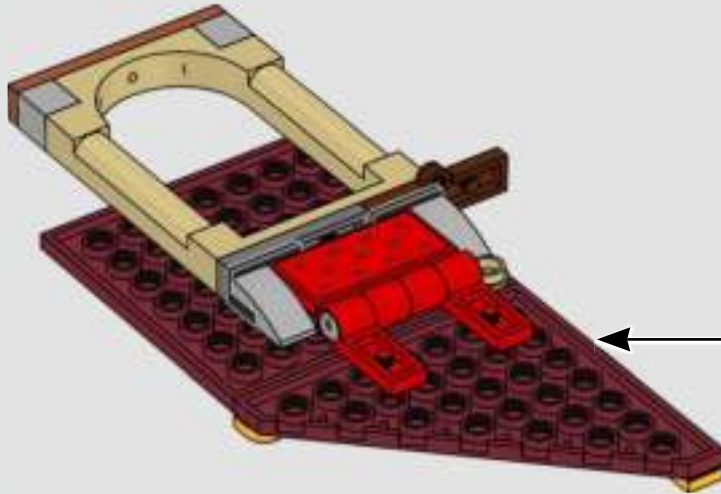
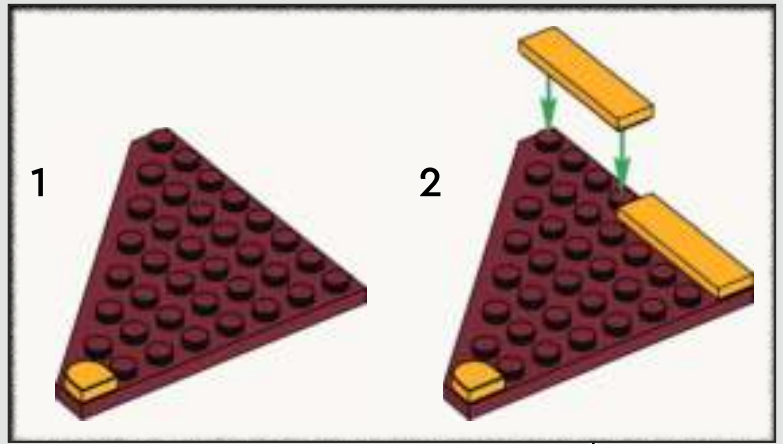



44

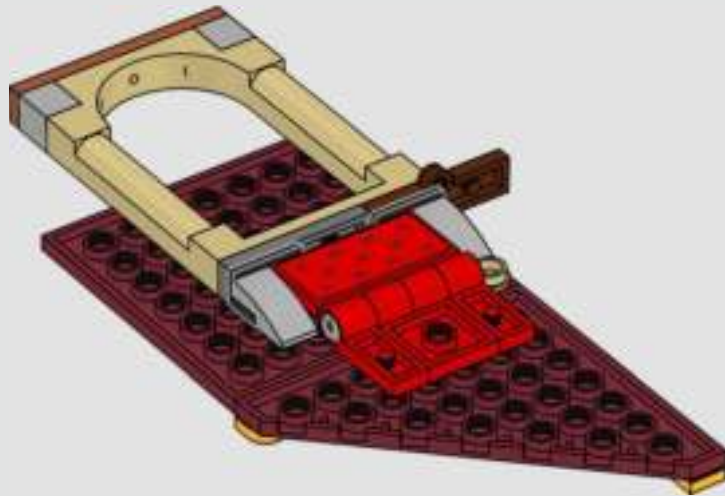

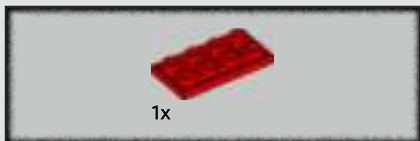

45

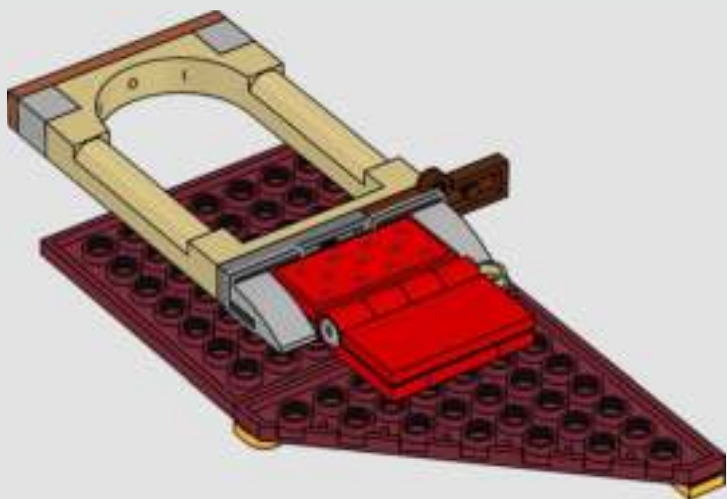

46

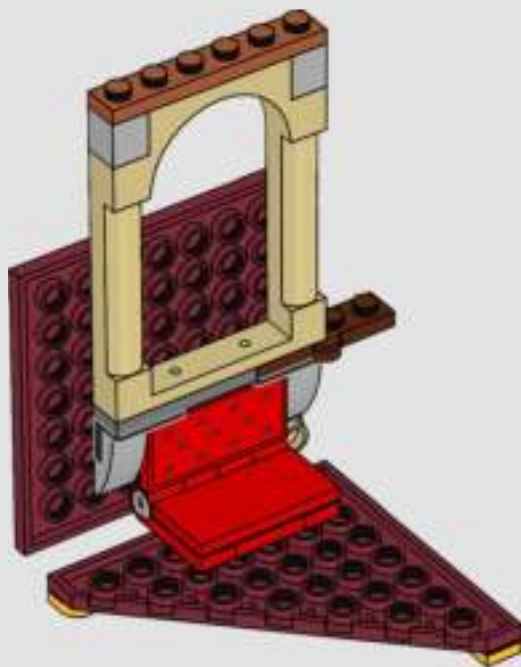

47

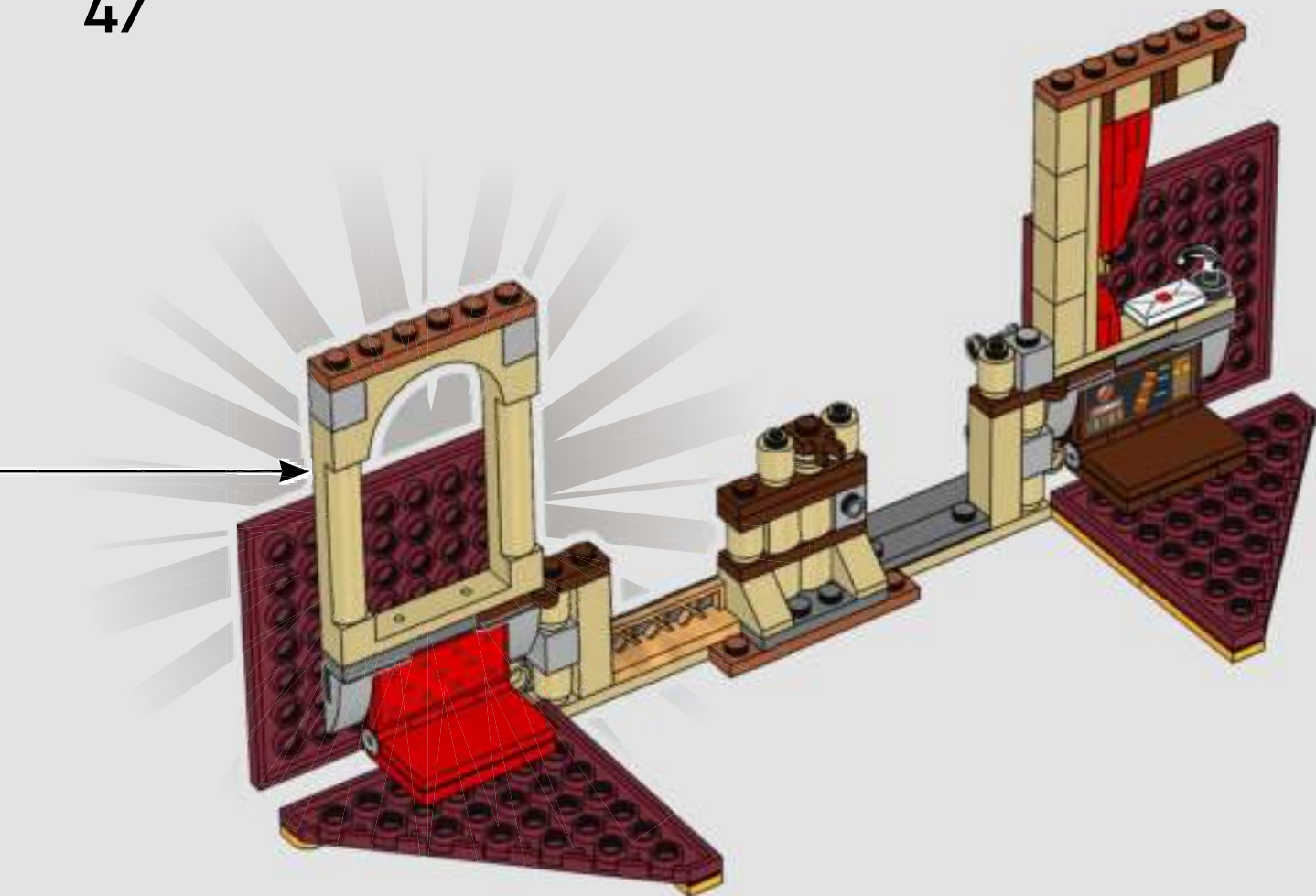

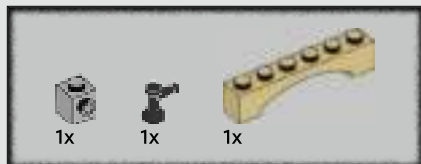

48

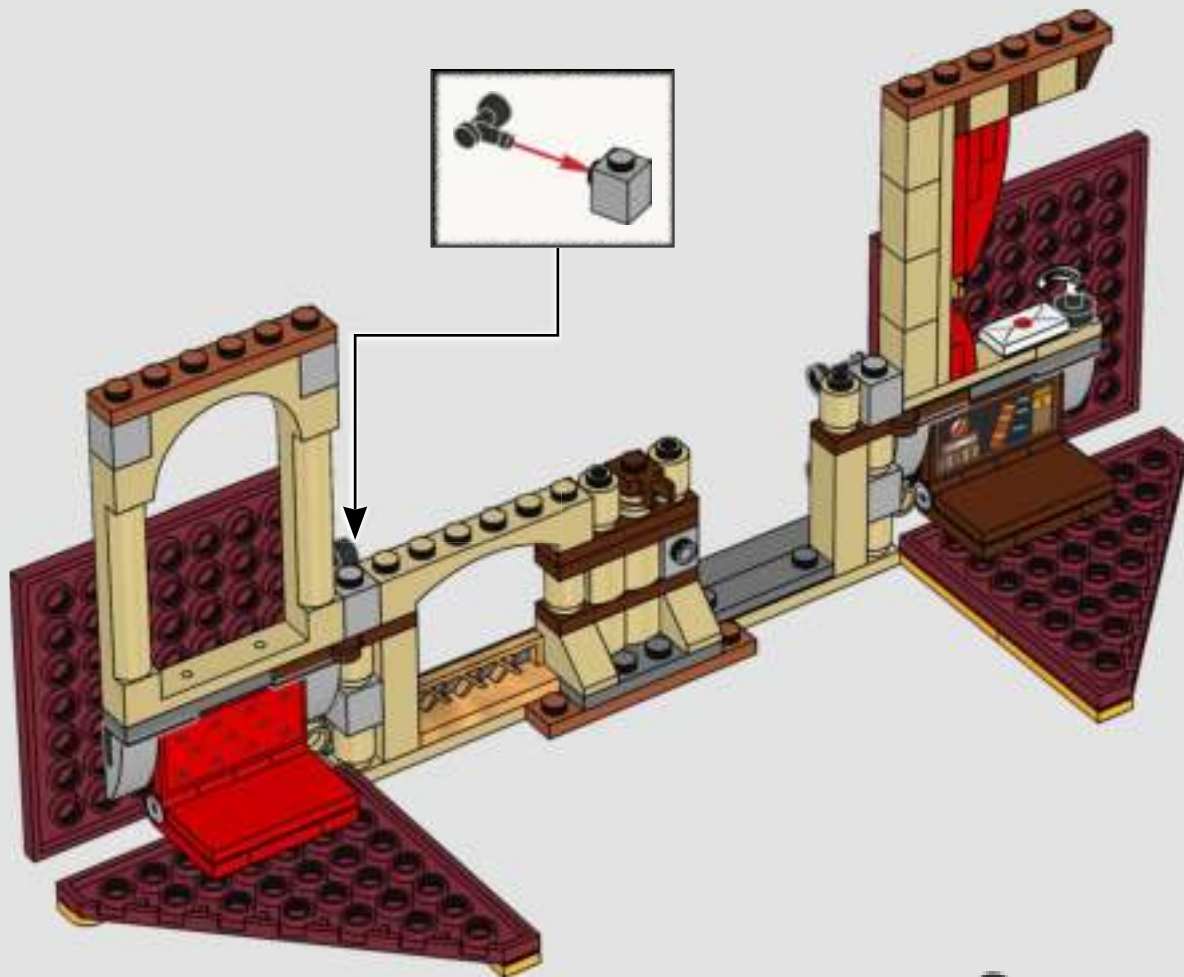
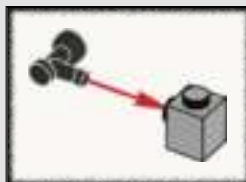



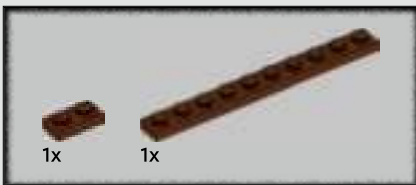

49

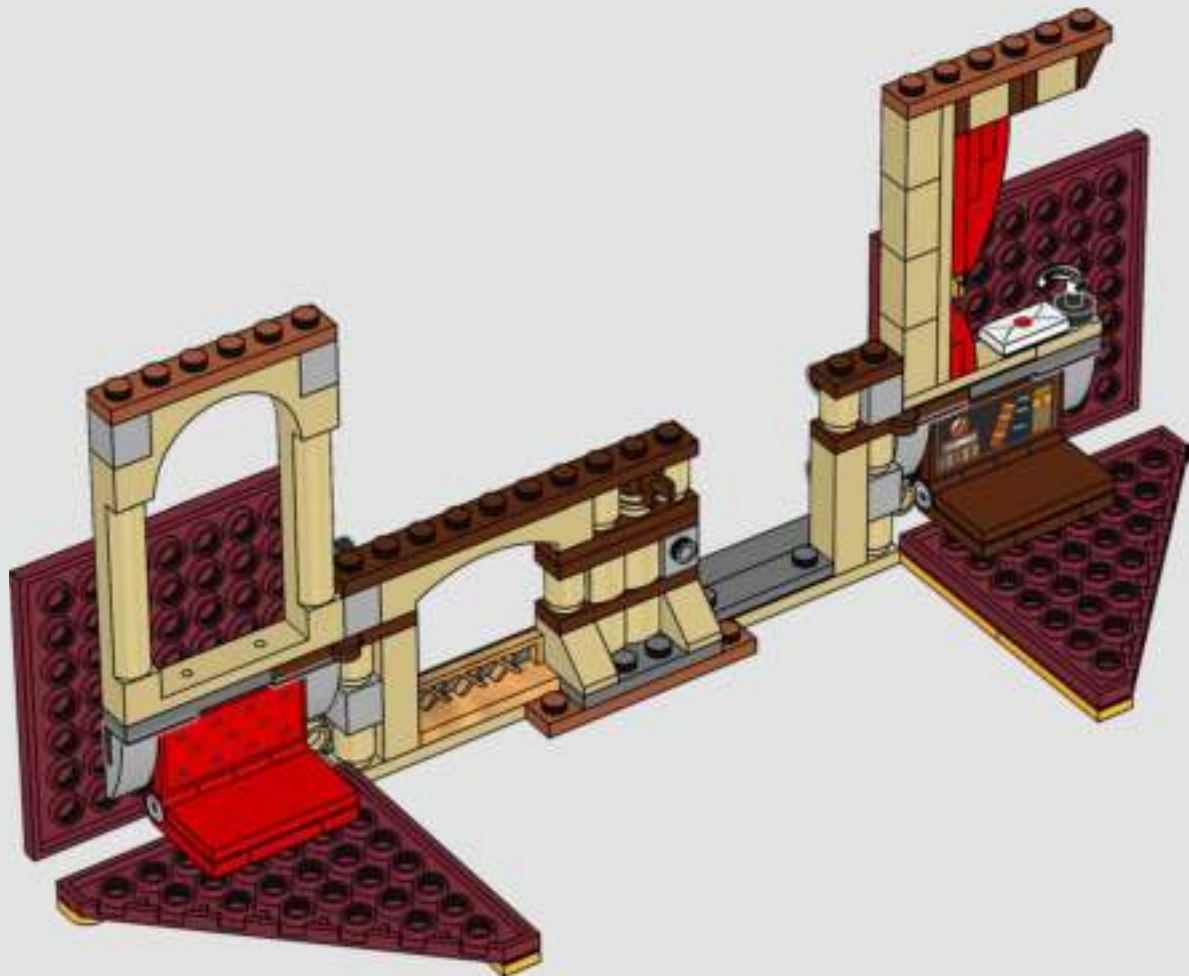

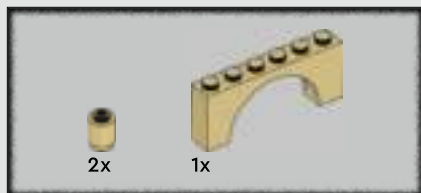

50

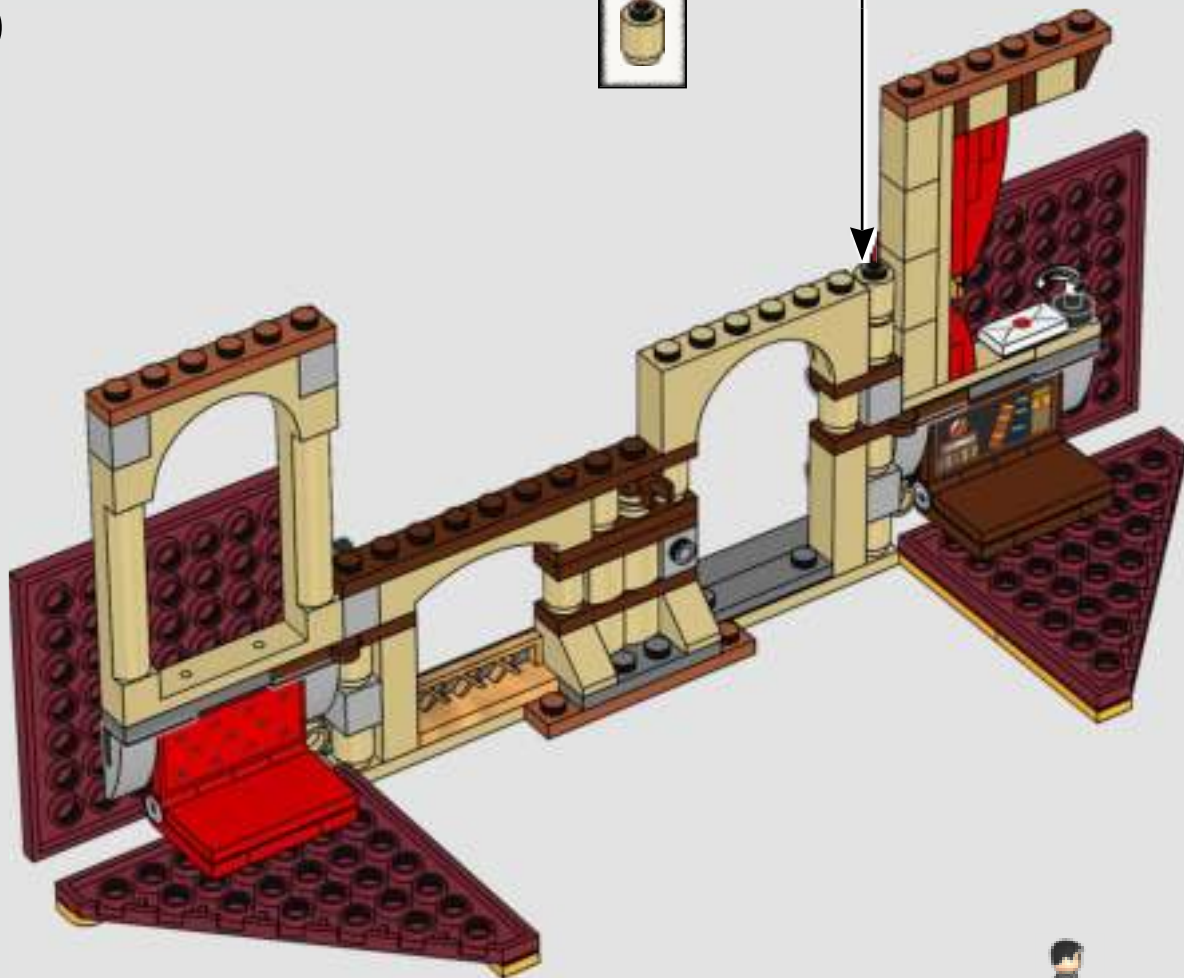



51

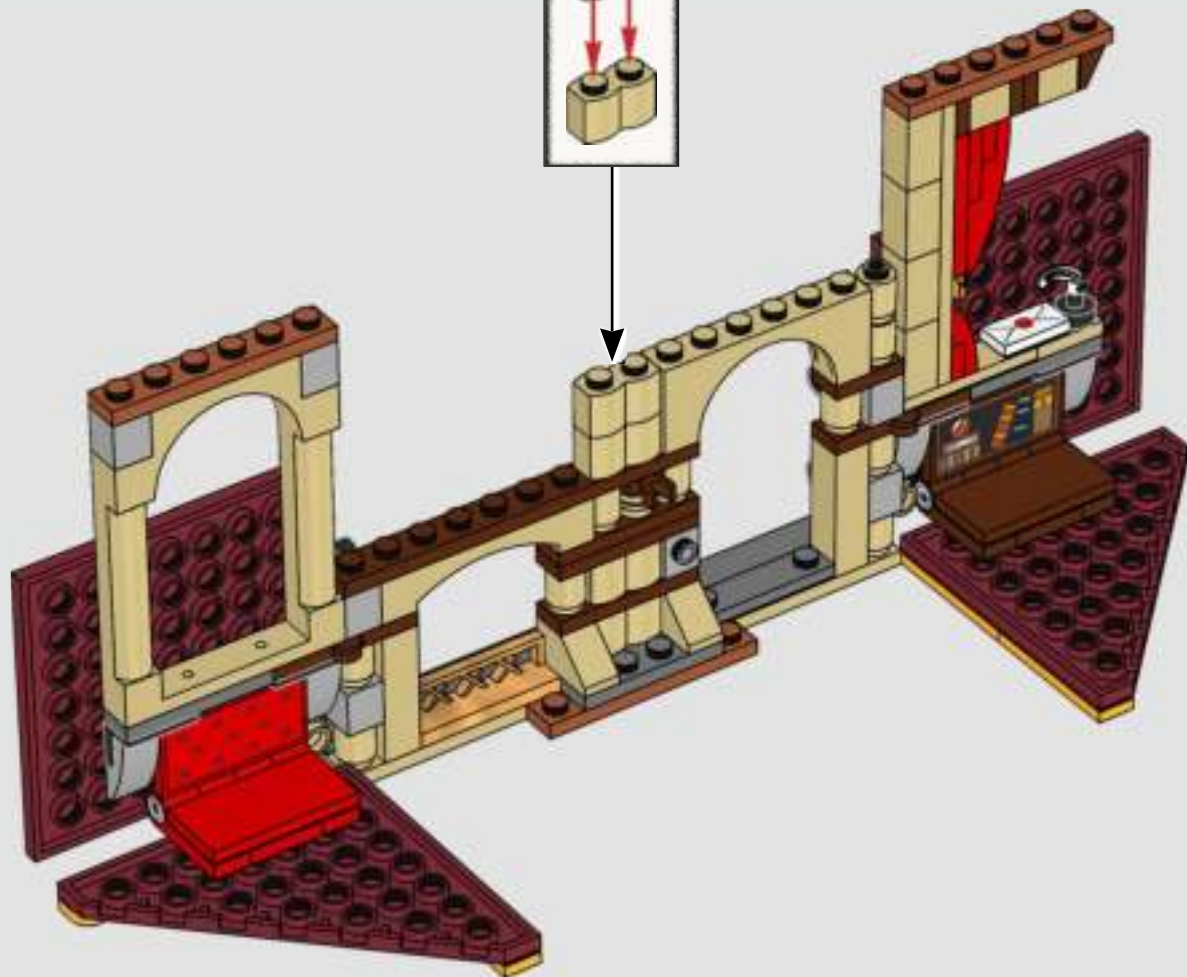
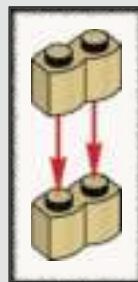

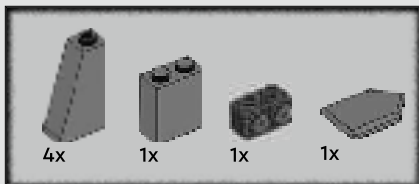

52

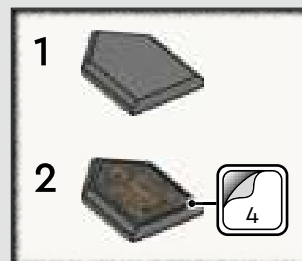
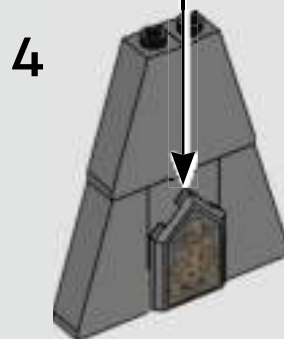
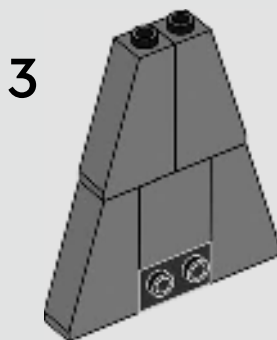
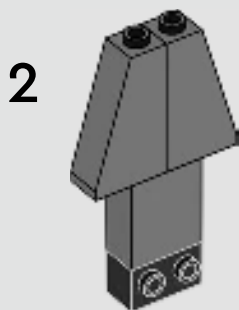
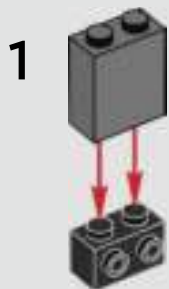

53

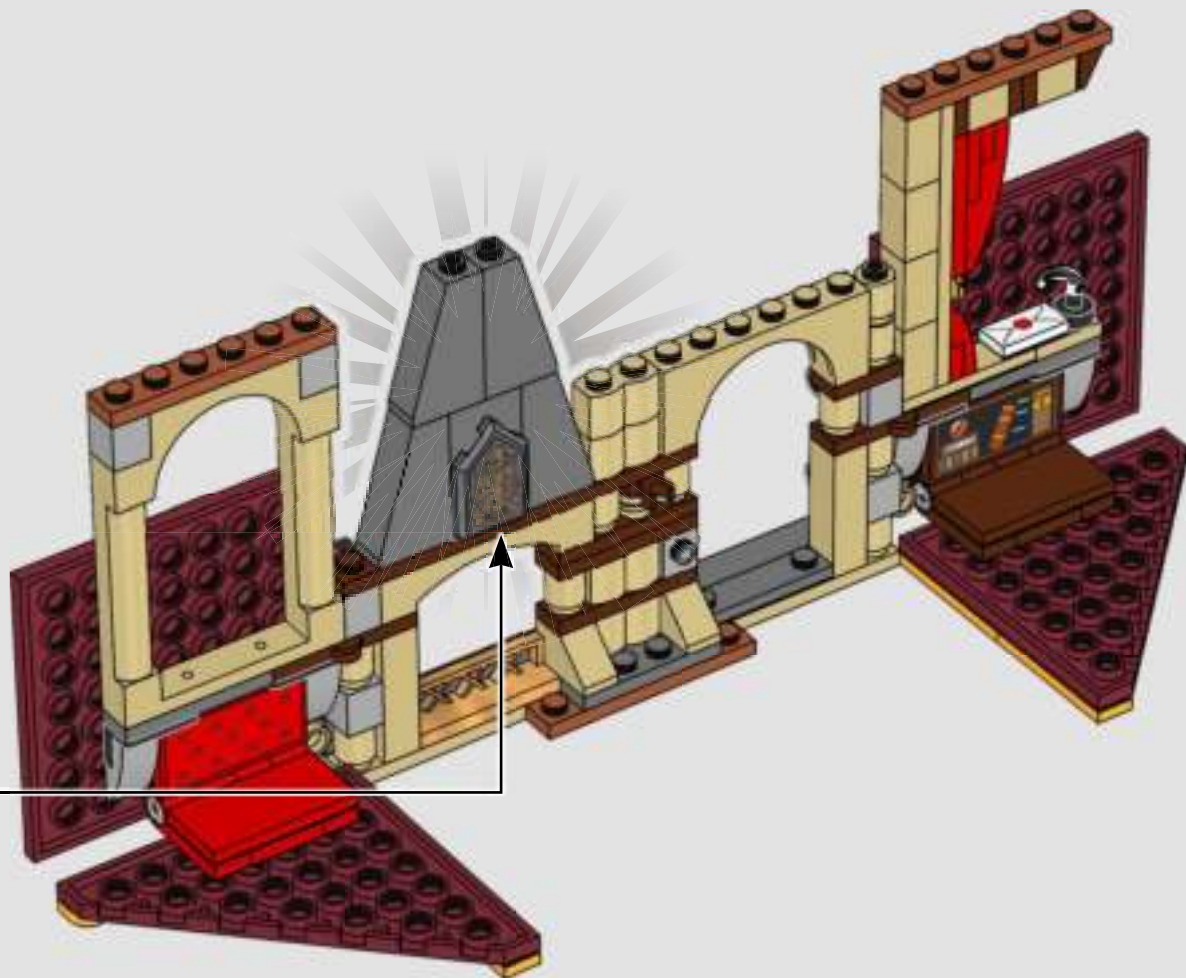



54

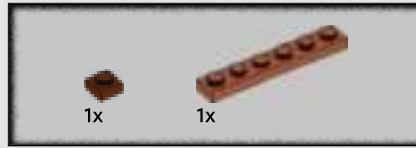
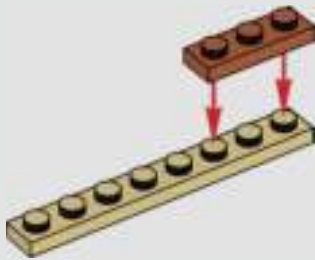

55

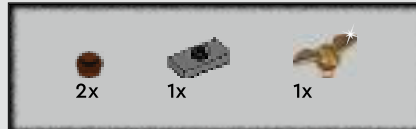
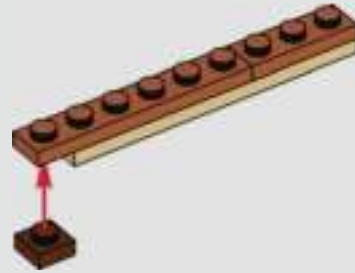

56



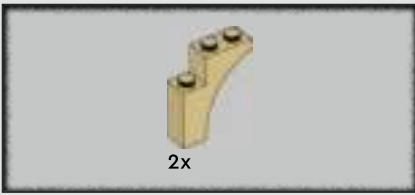

57

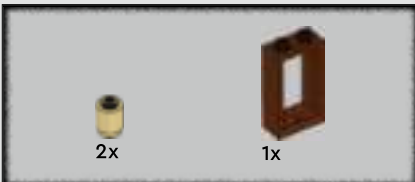
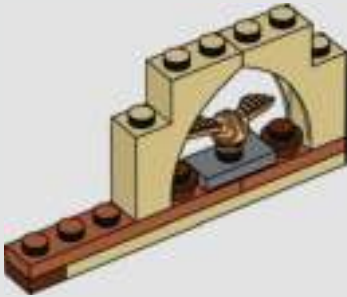

58

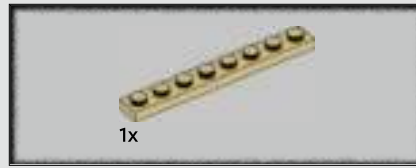
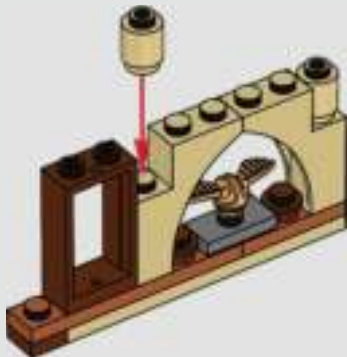

59



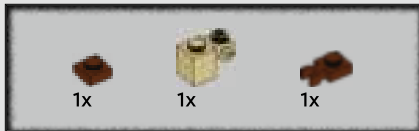

60

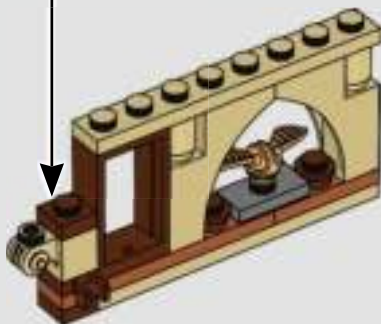
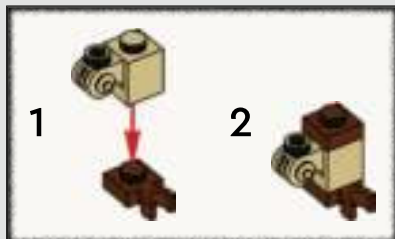

61

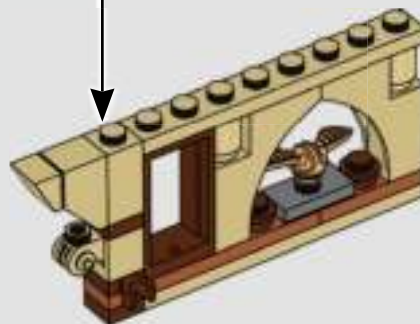
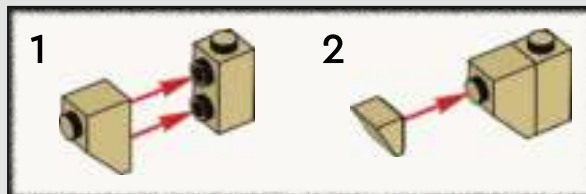



62

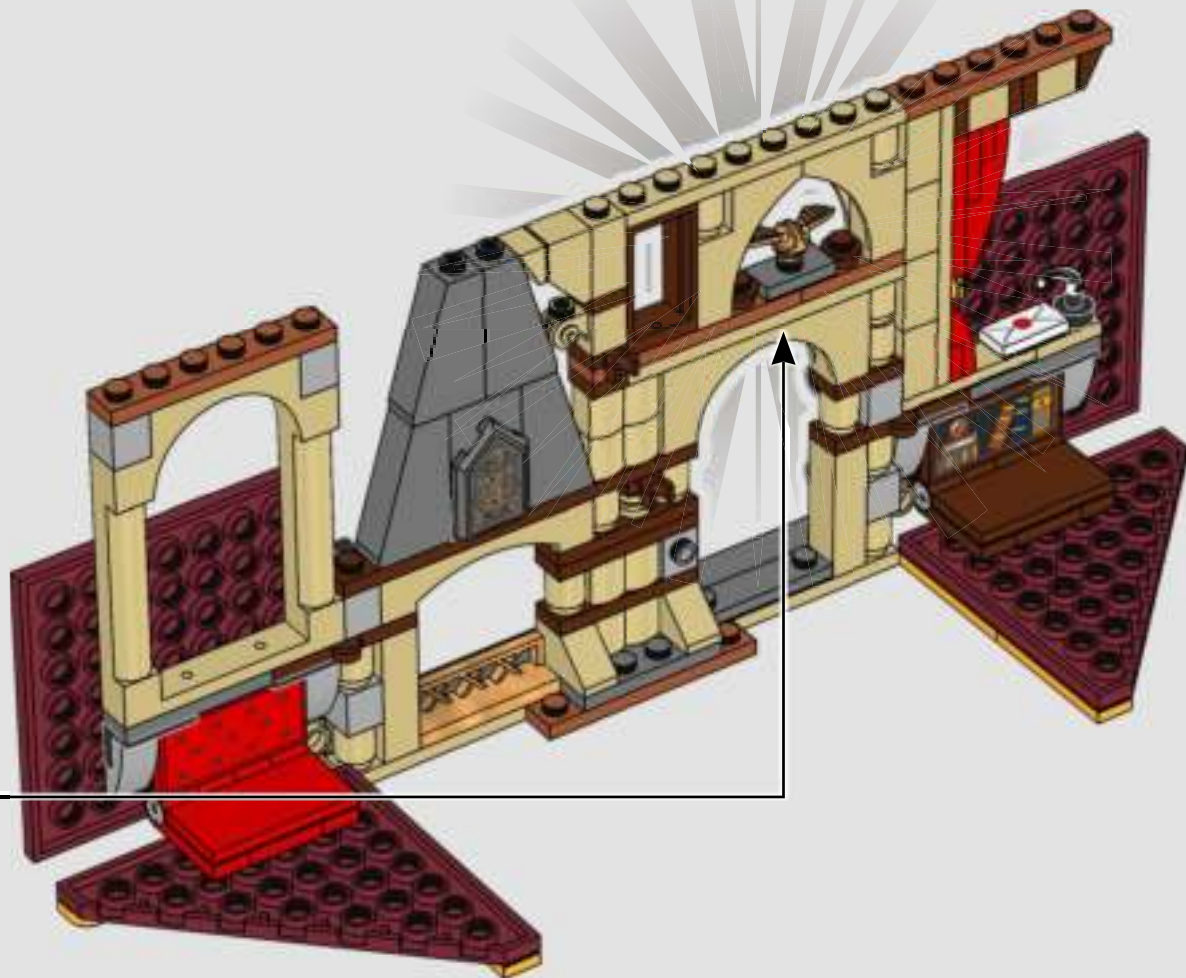



63

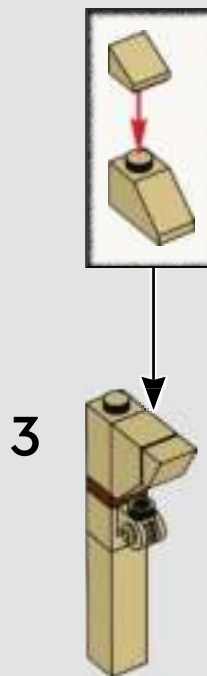

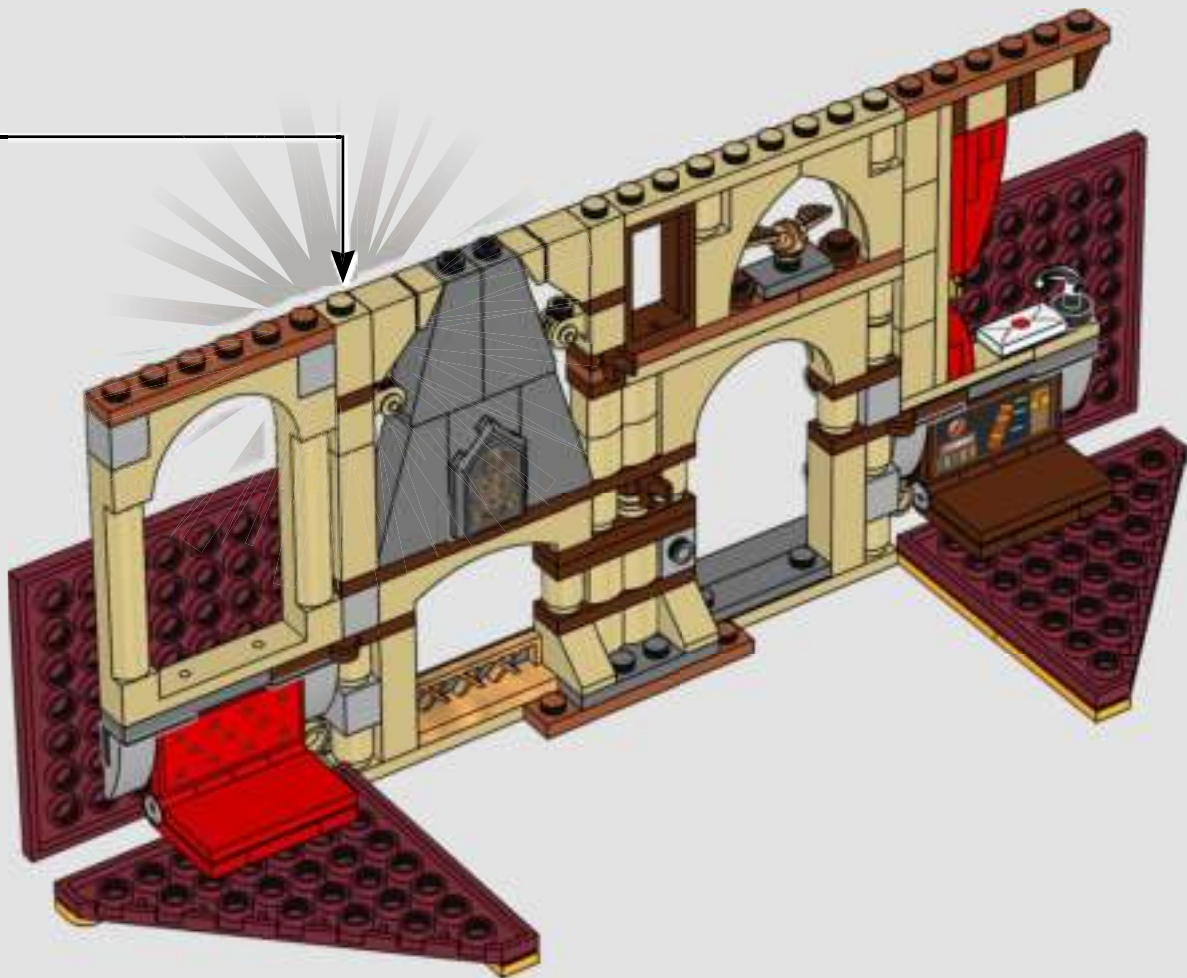



64

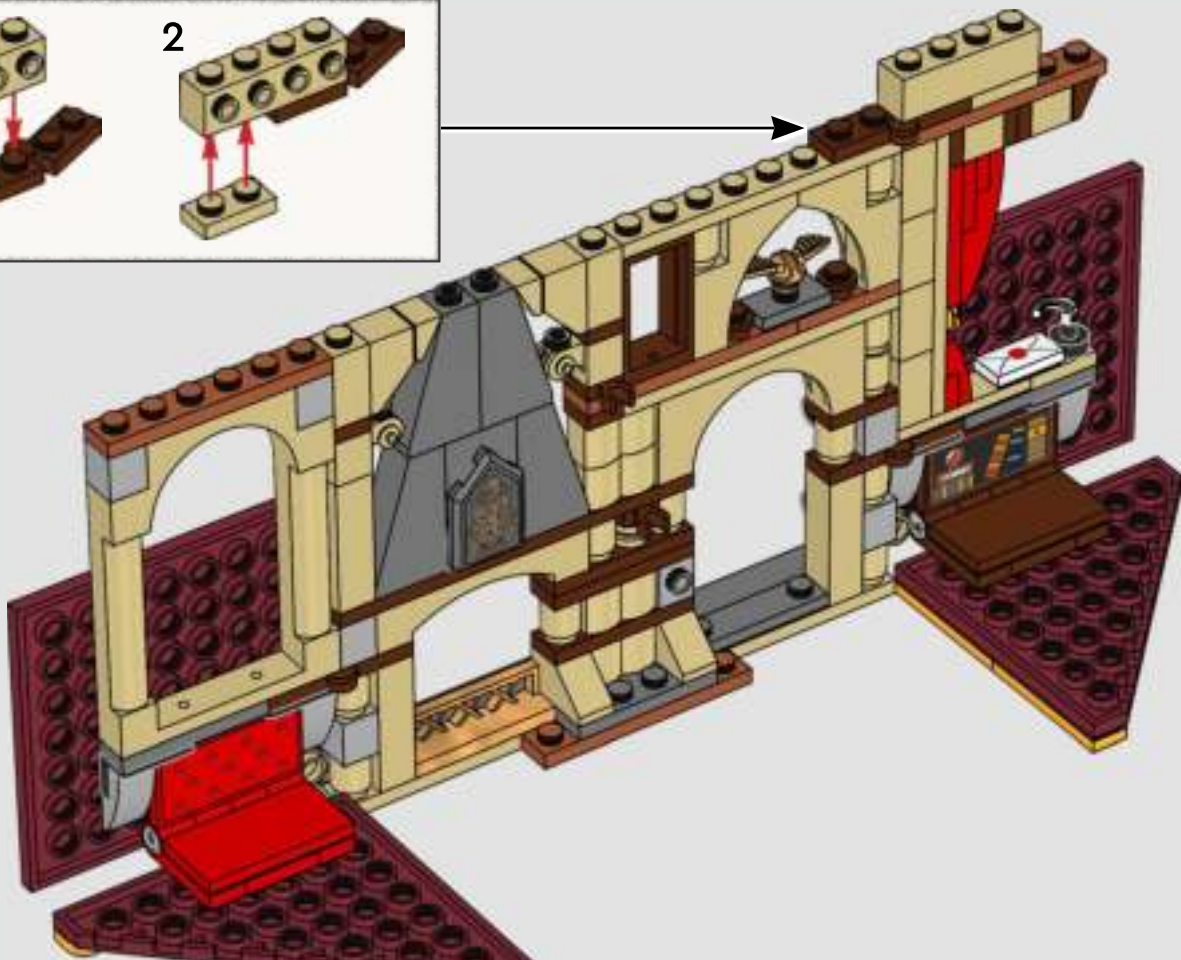
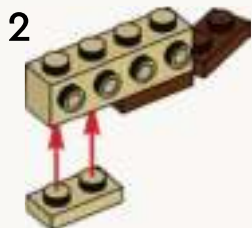
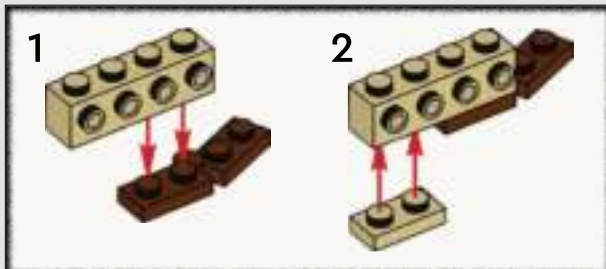



65

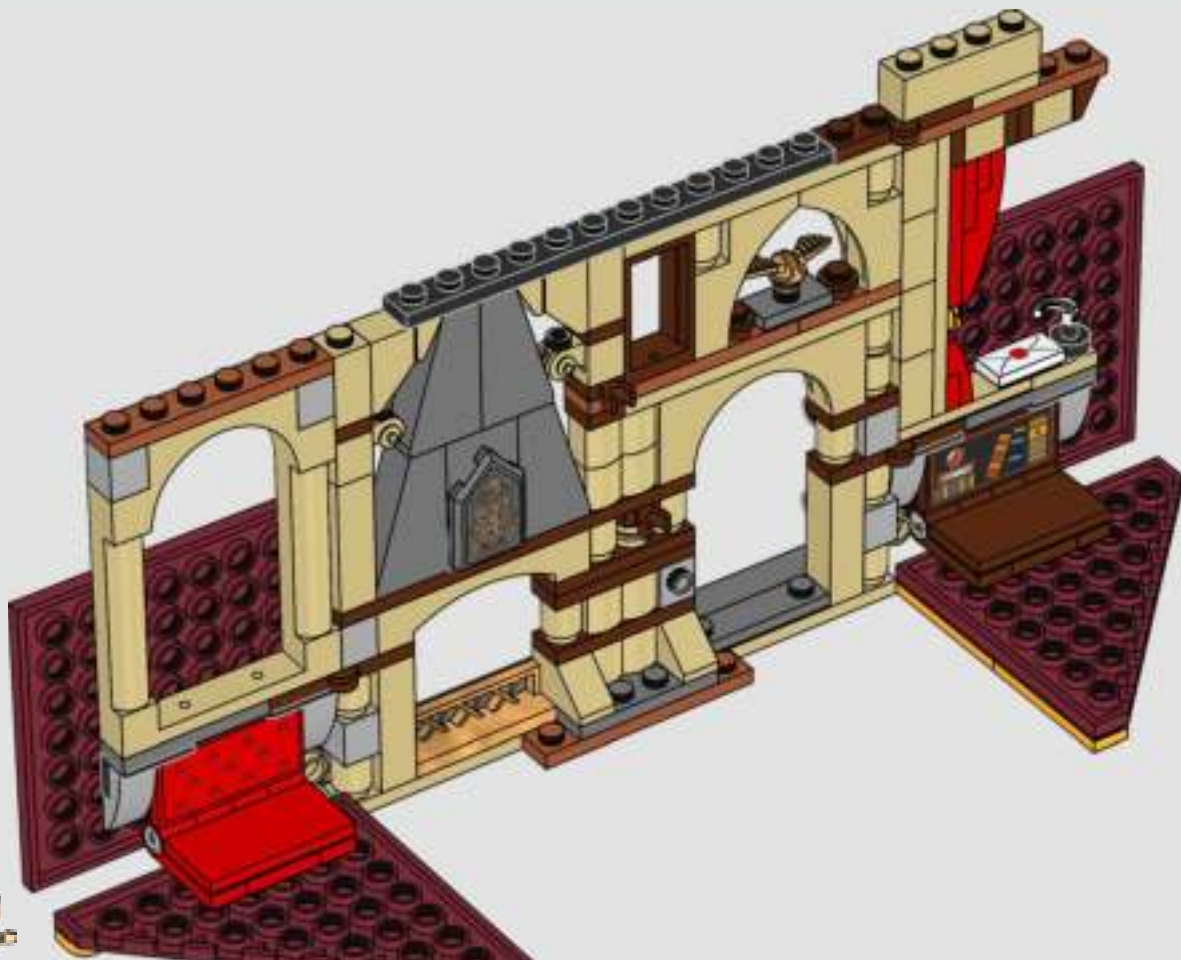



66

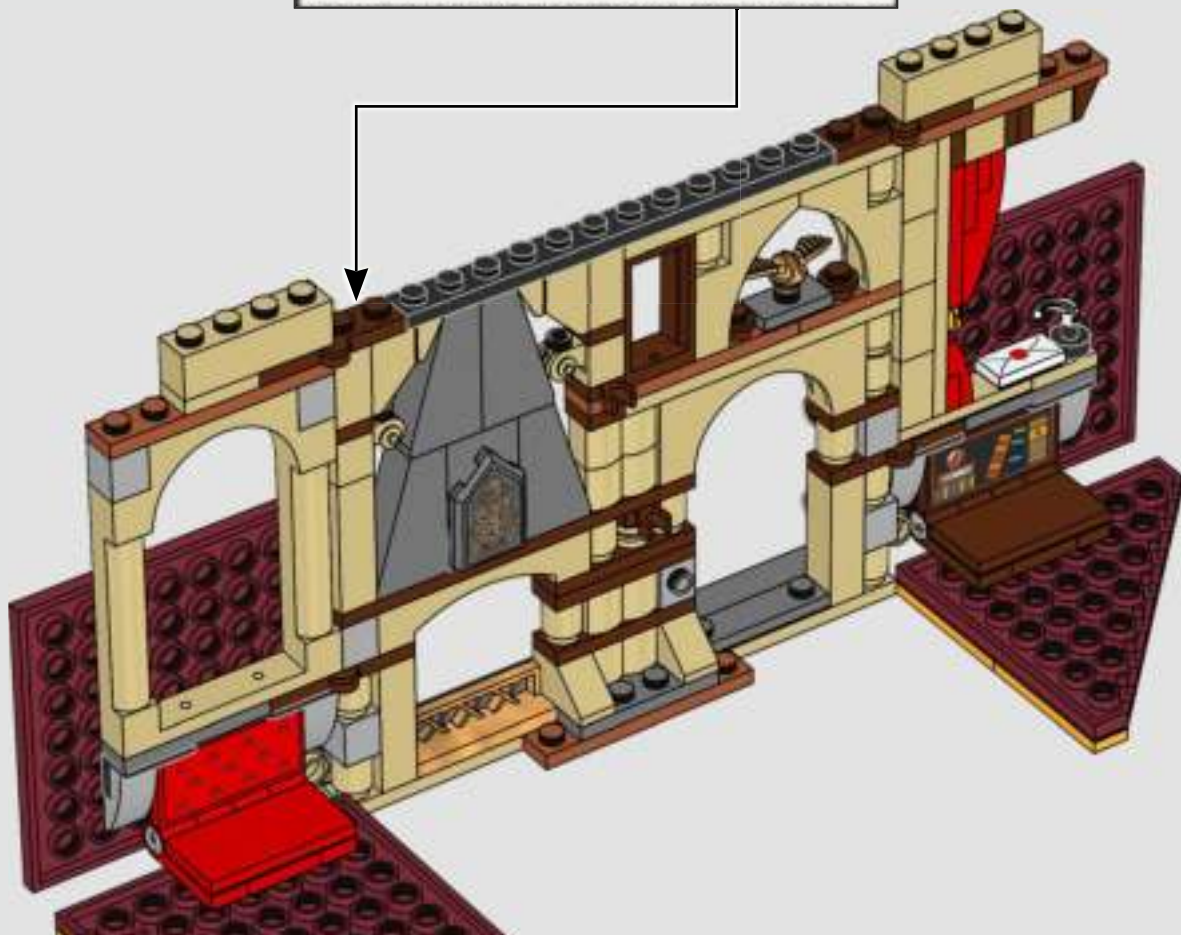
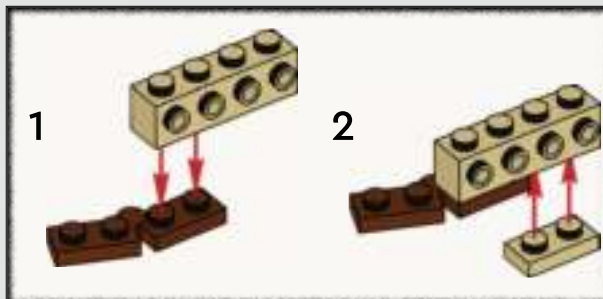



67

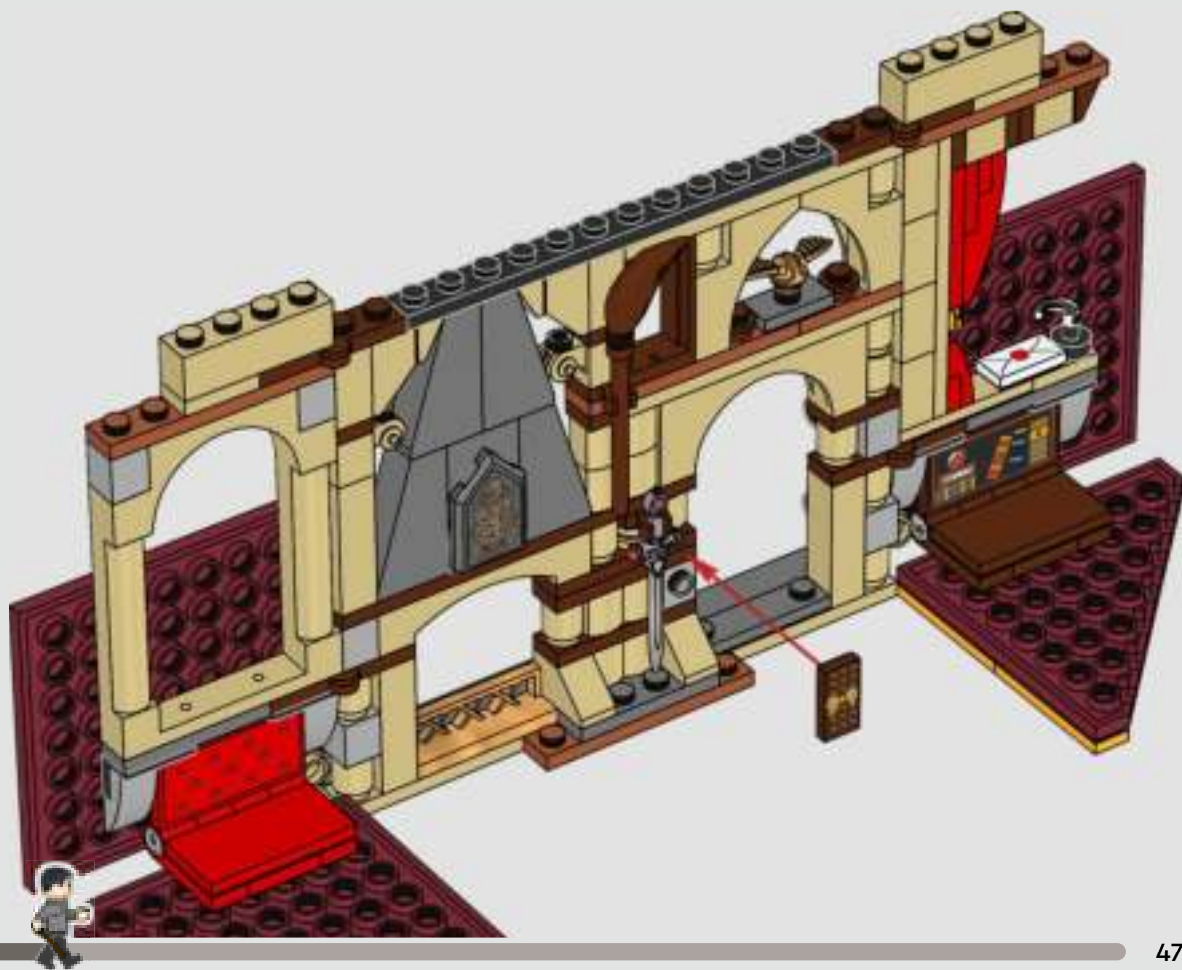

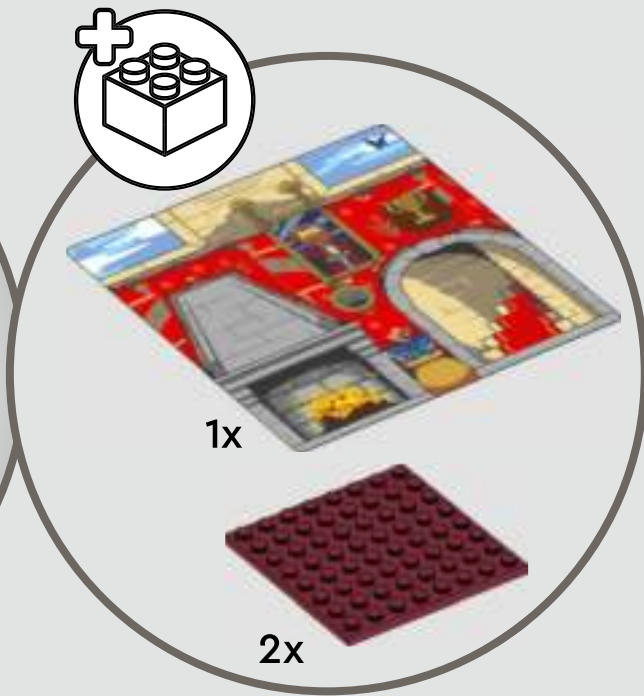



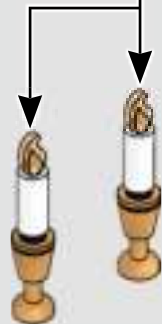
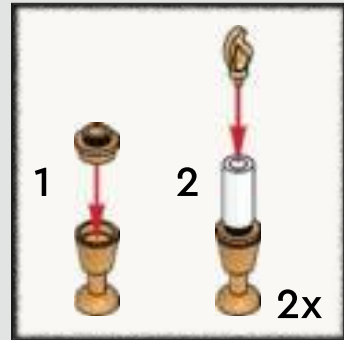

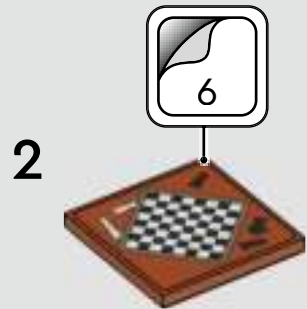
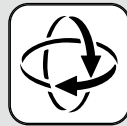
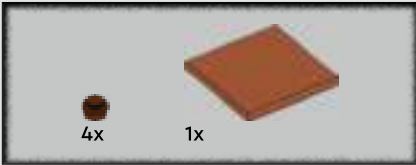
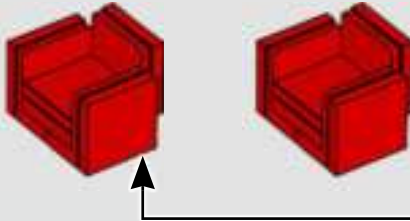
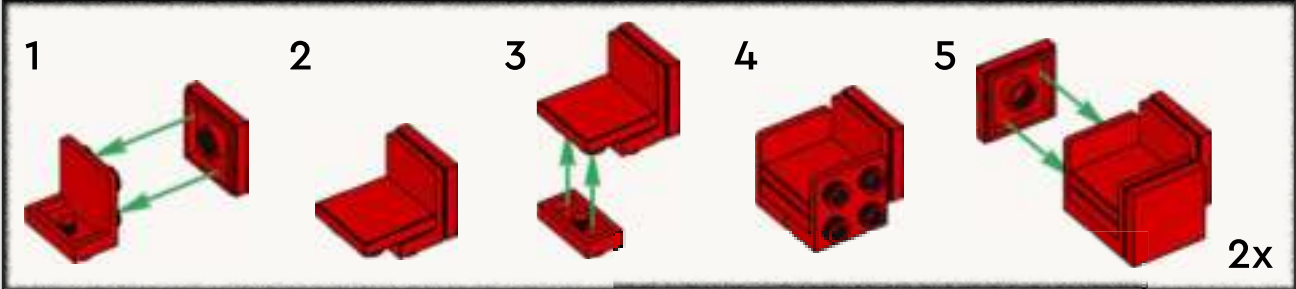
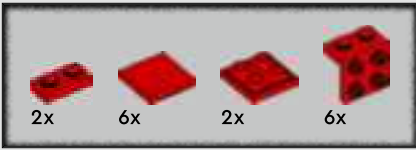

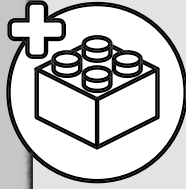

68

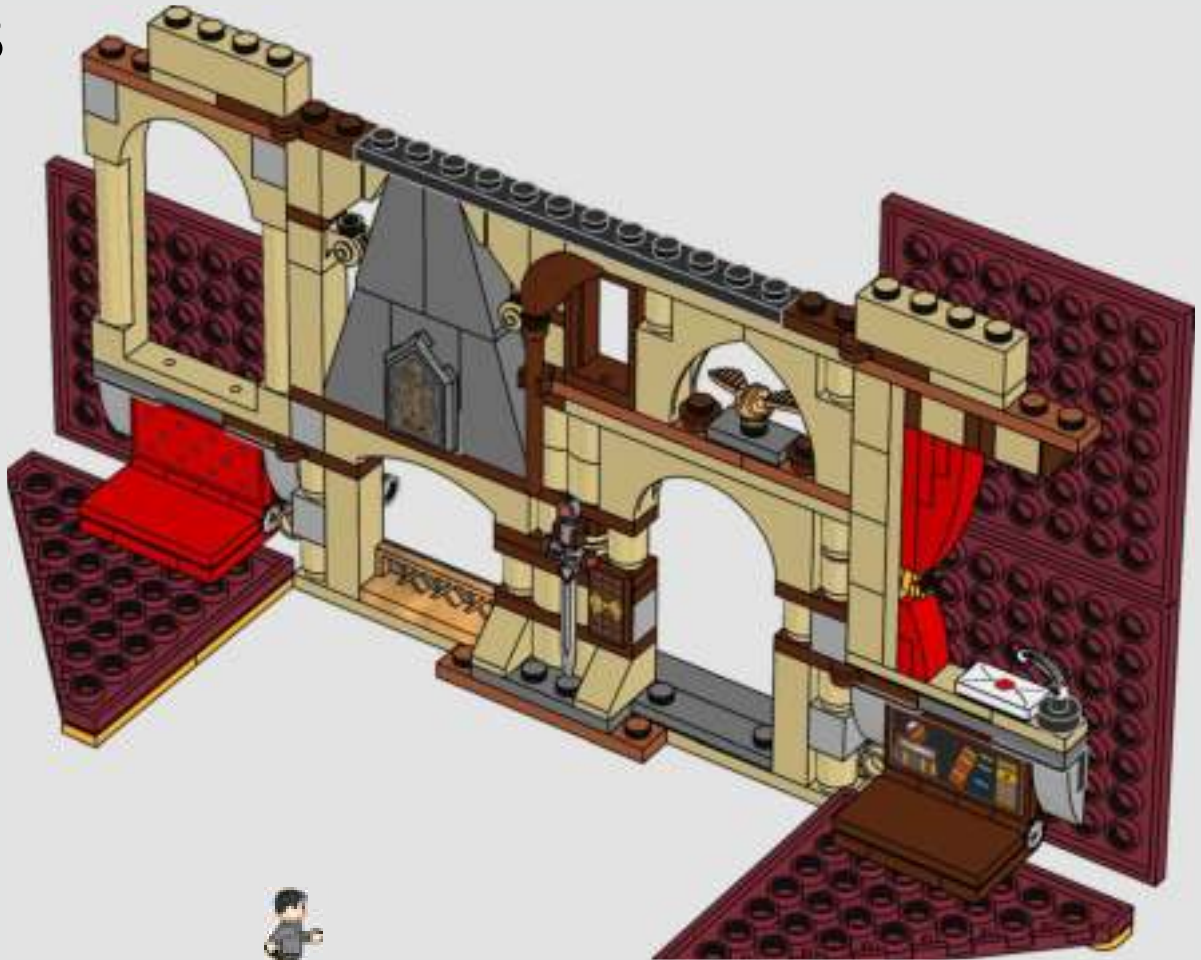



69

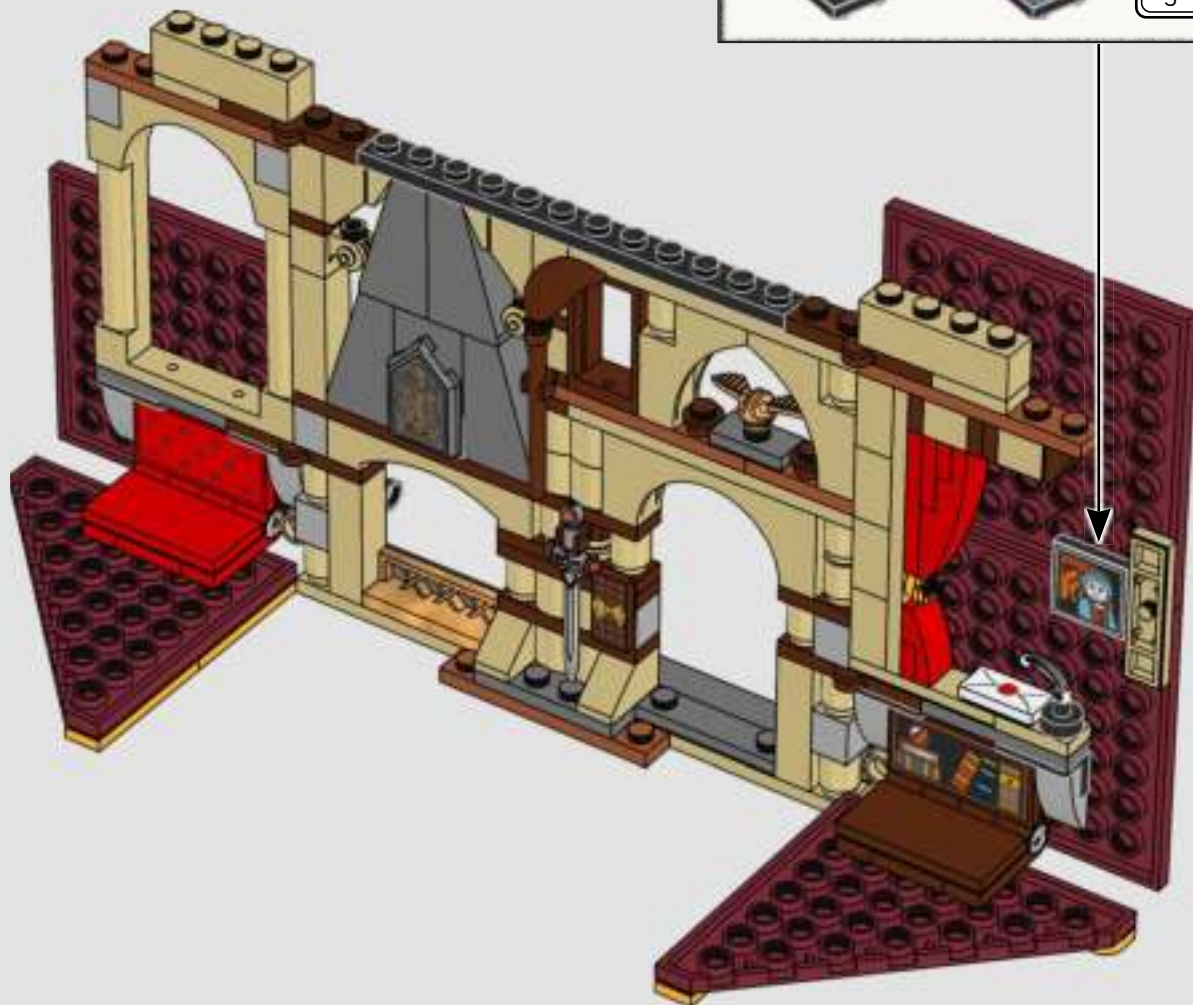



70



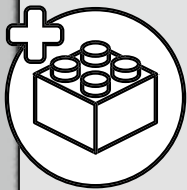
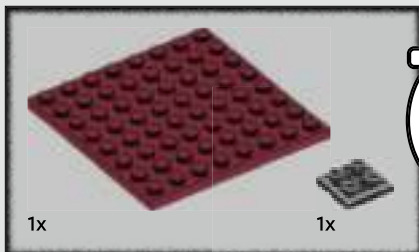

71

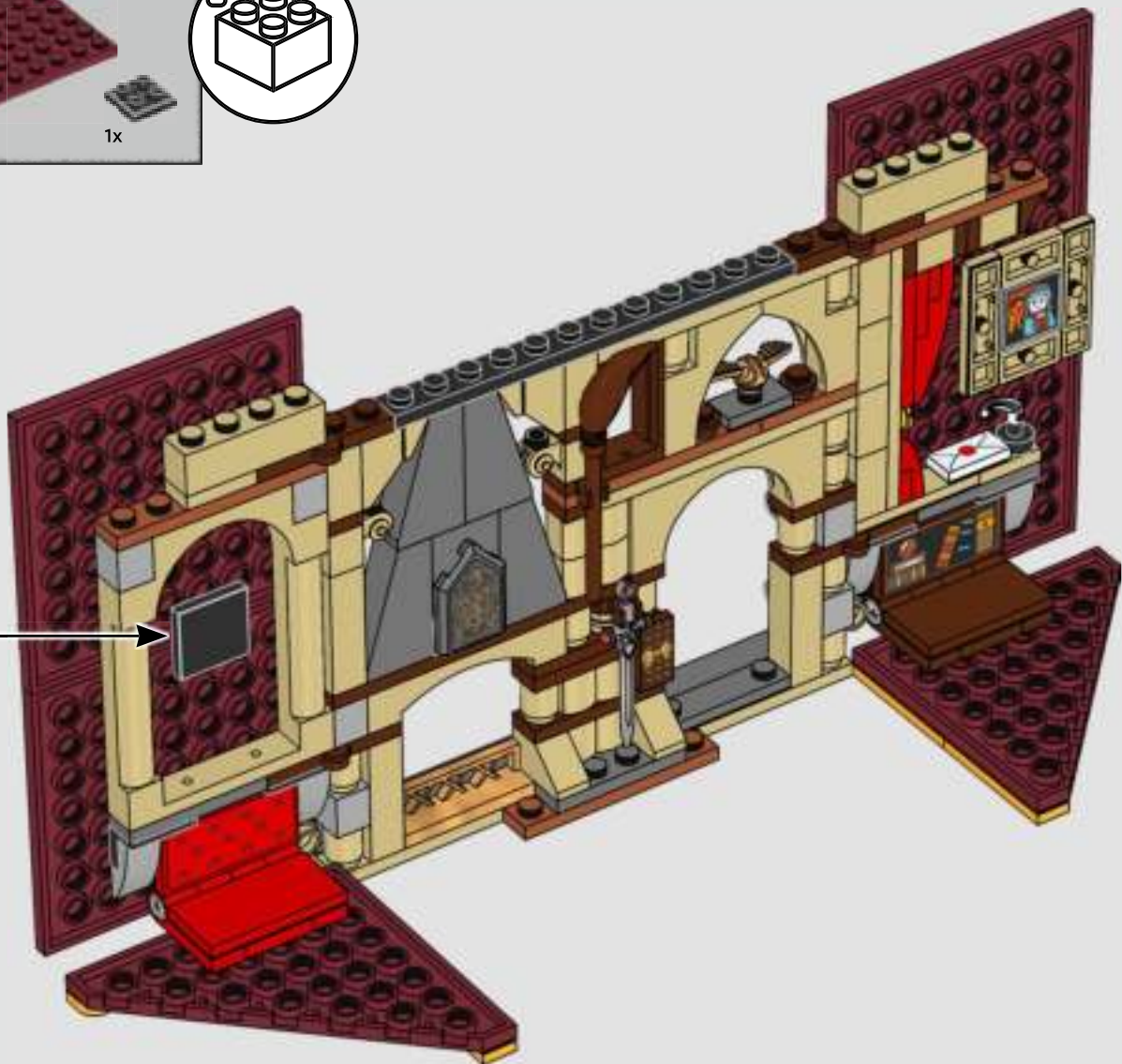

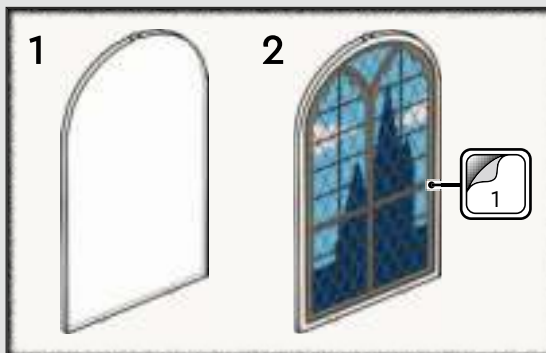

72

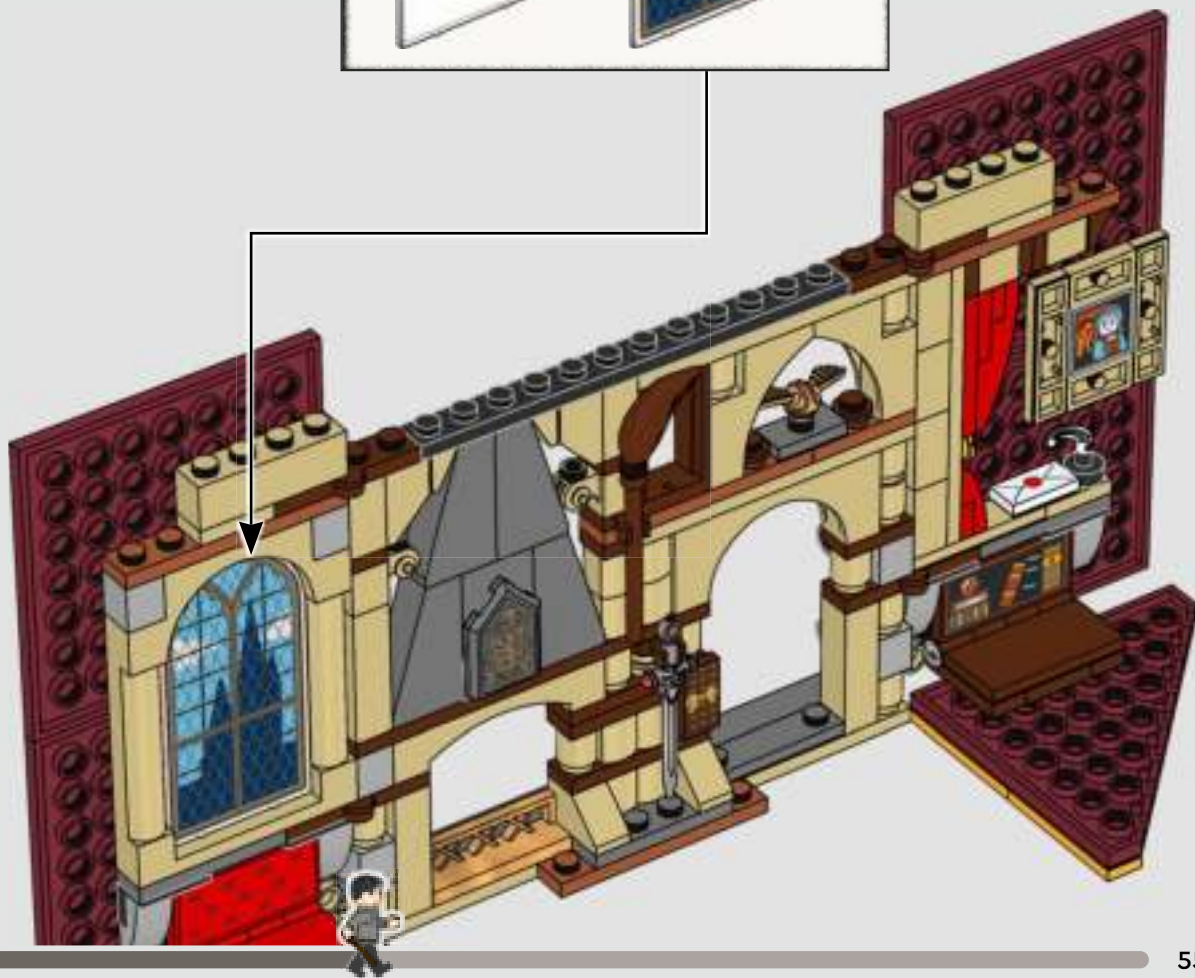



73

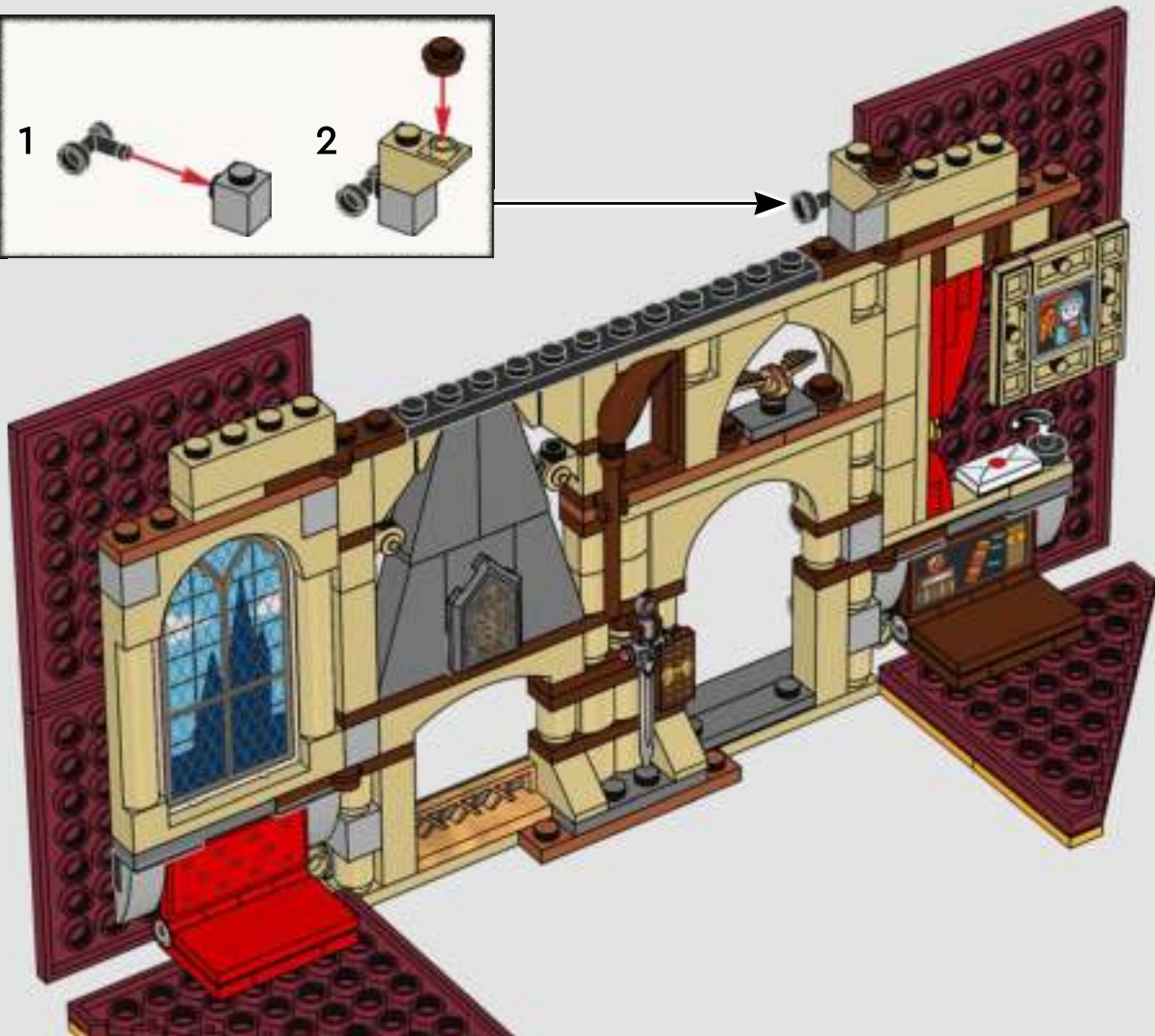
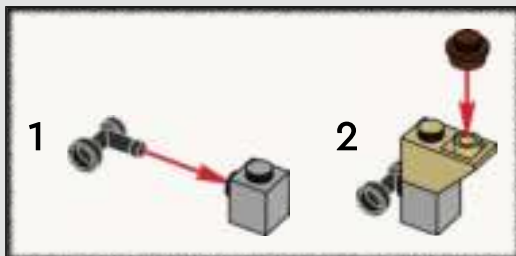





74

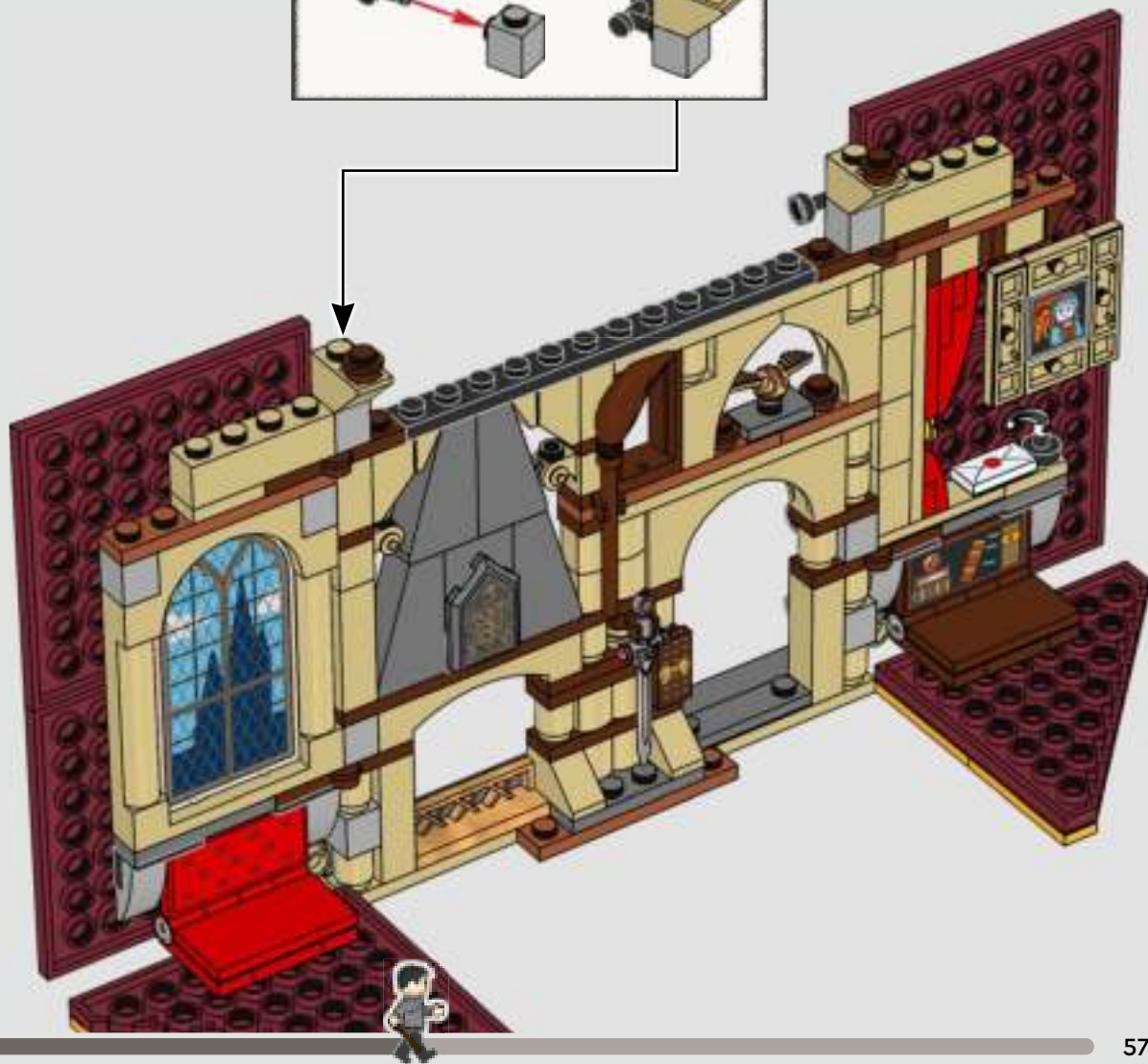
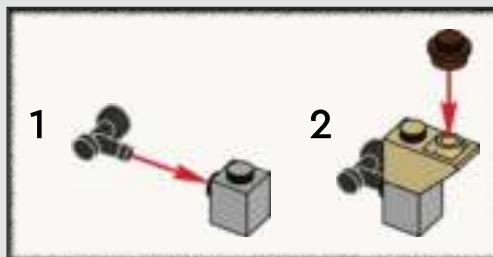



75

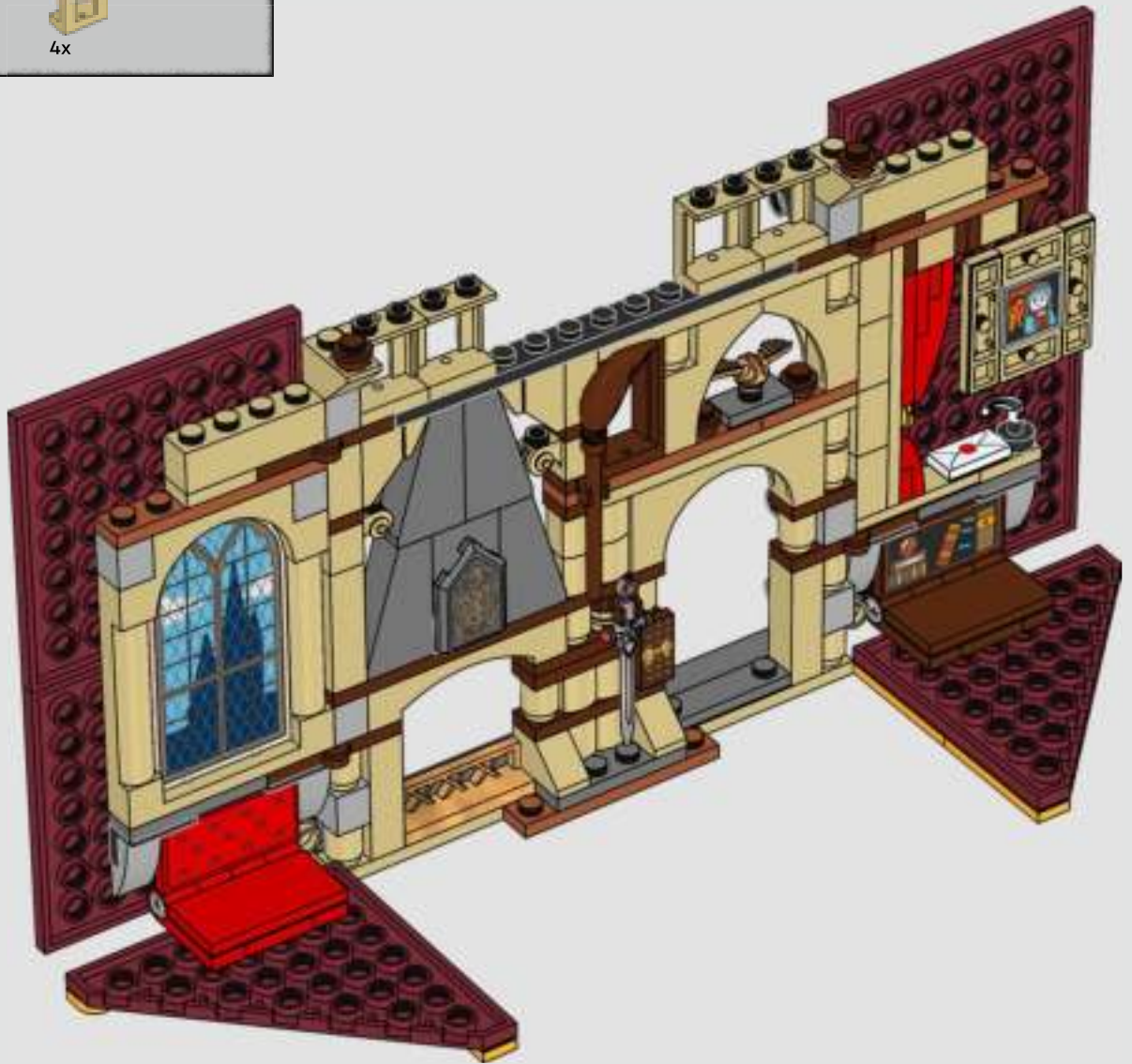

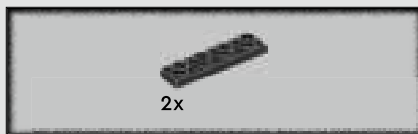

76

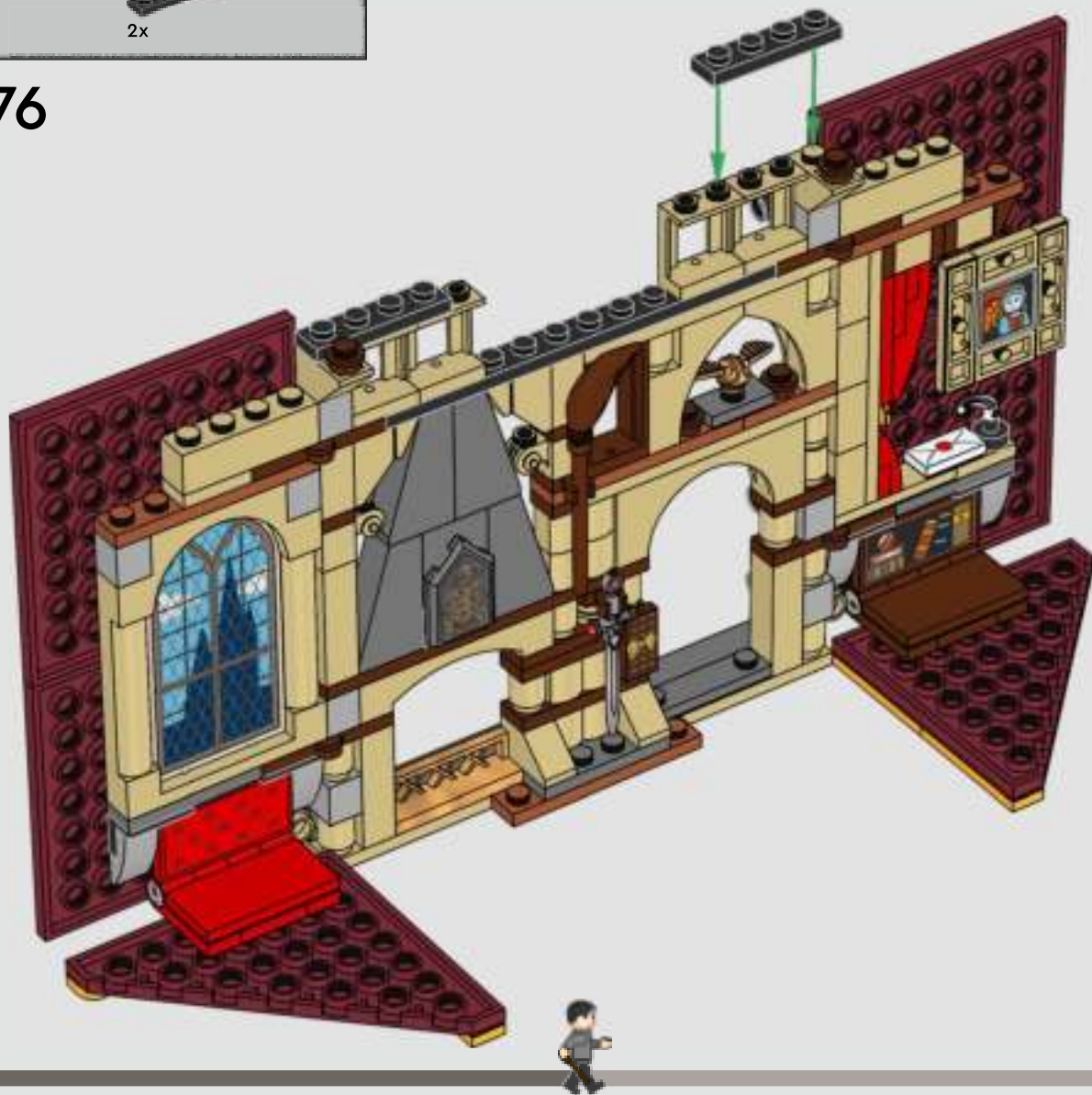

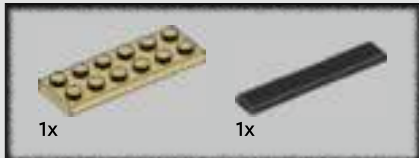

77

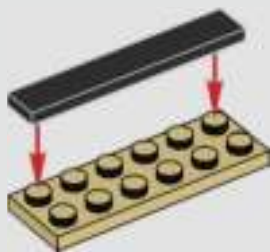

78



79

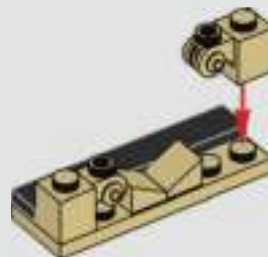

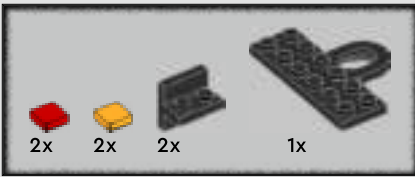

80

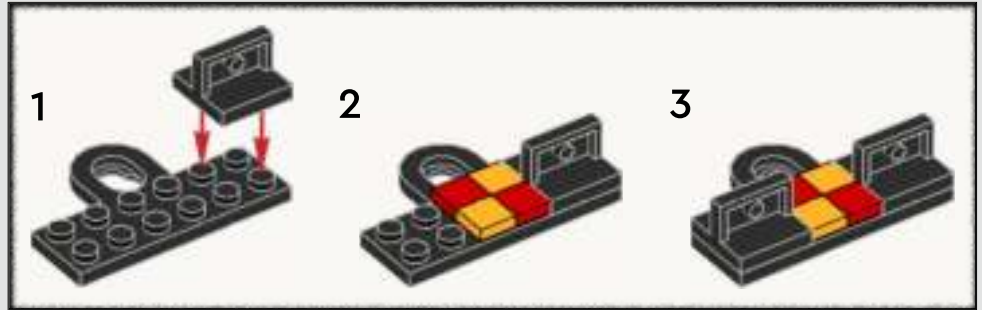

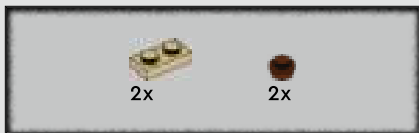

81

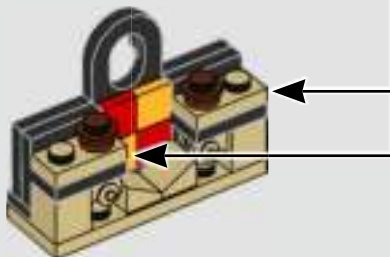

82

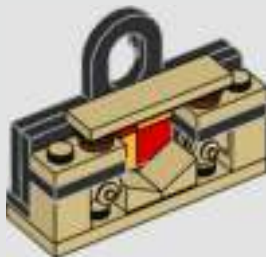

83

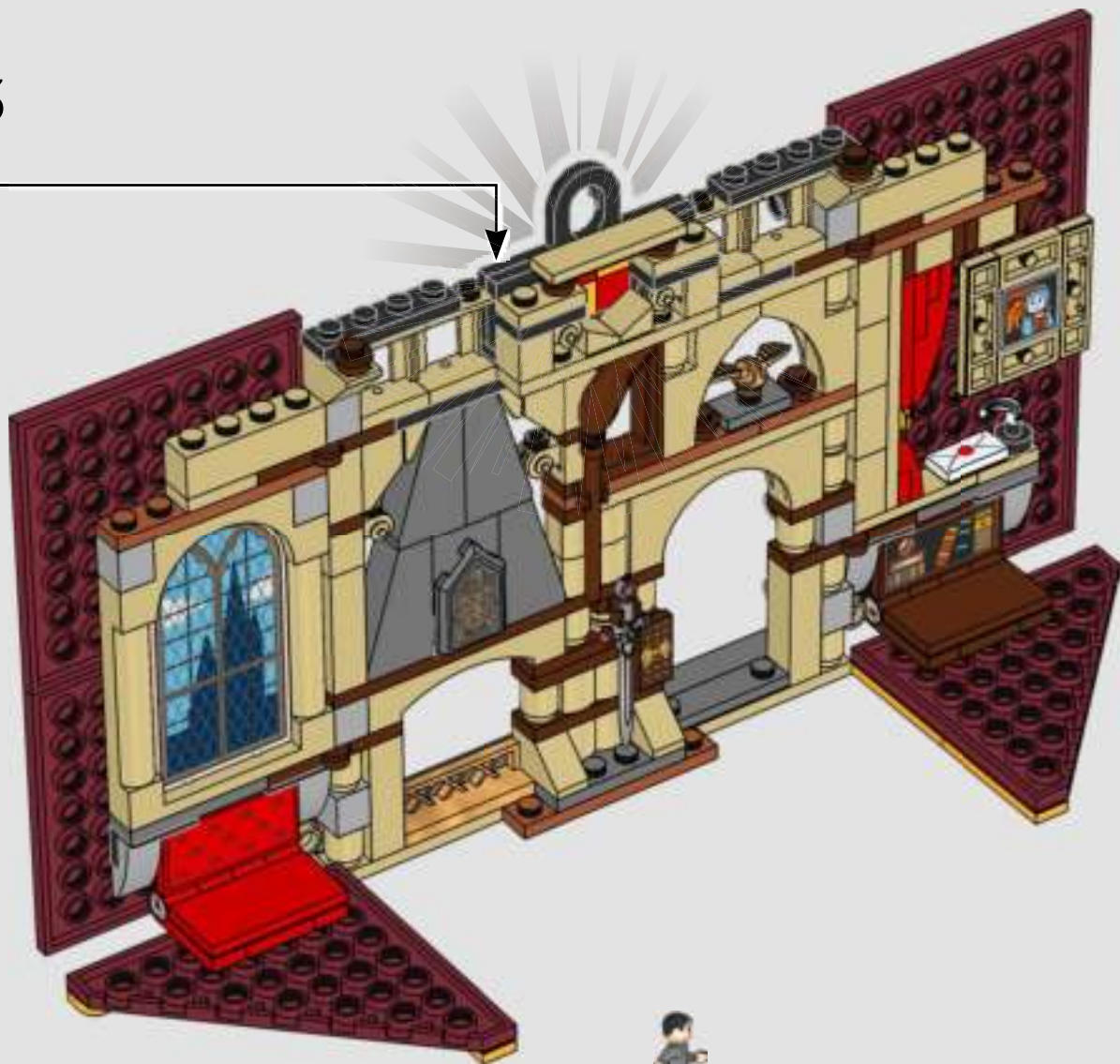



2x

84

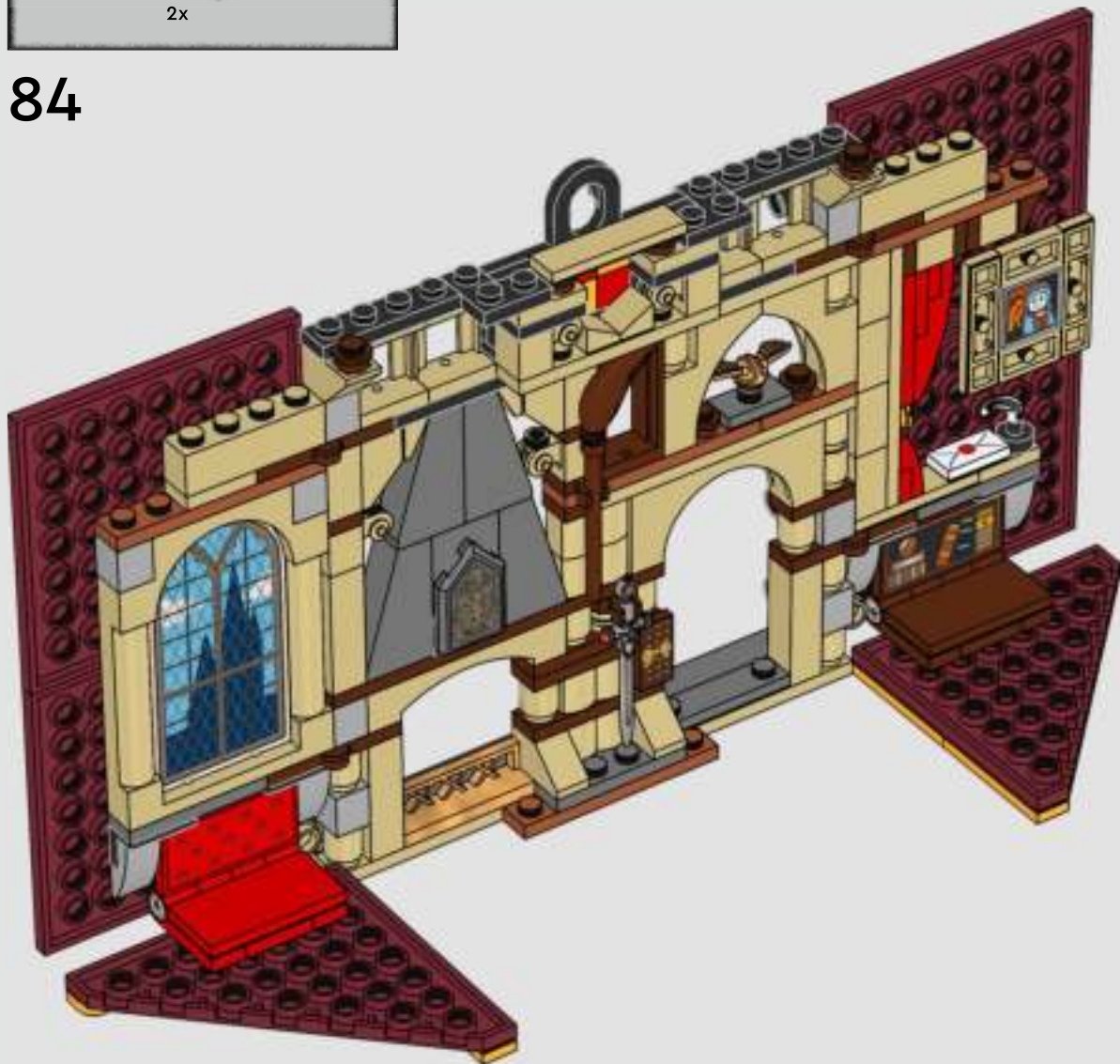



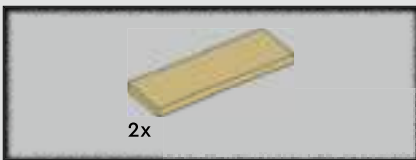

85

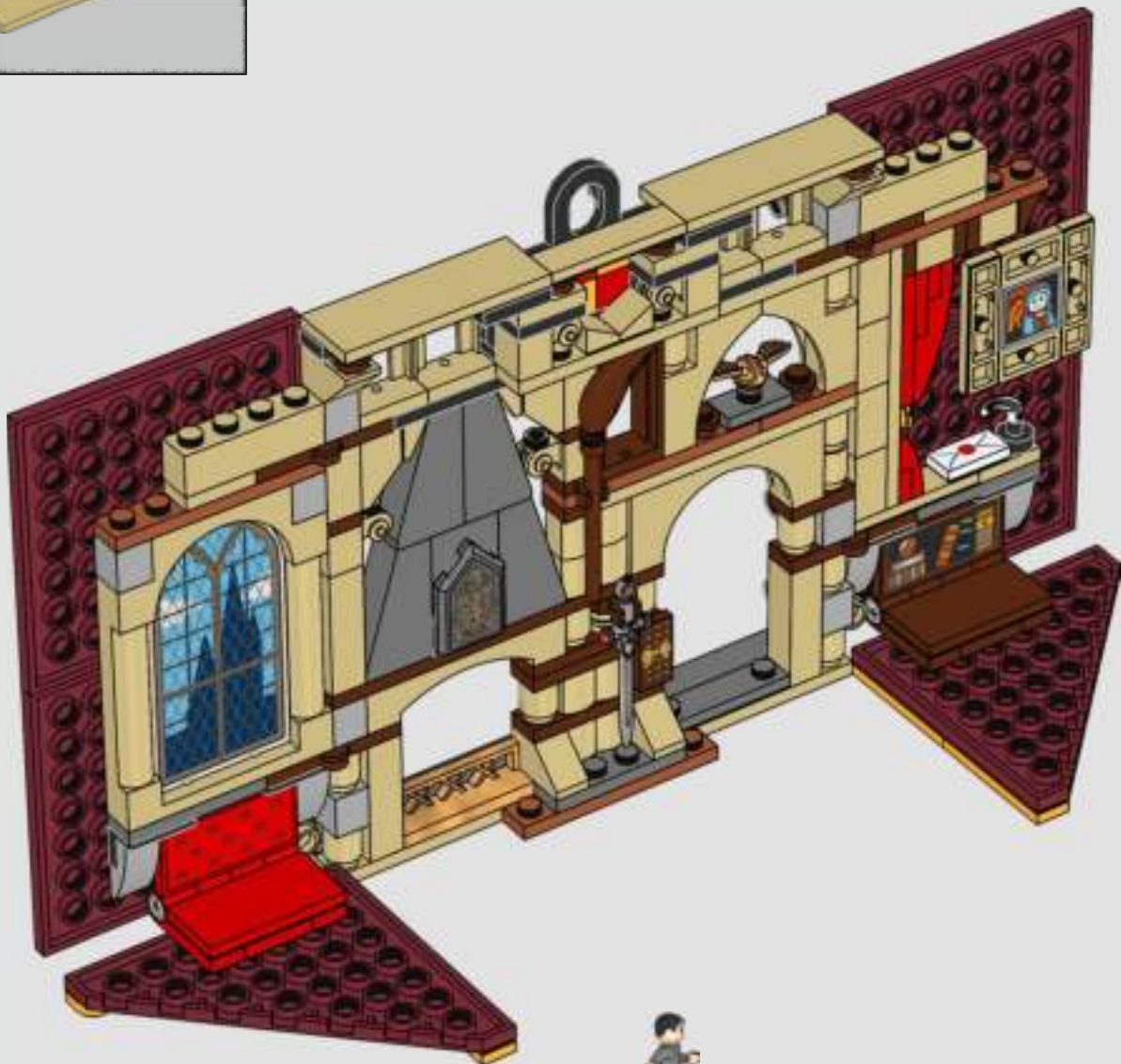

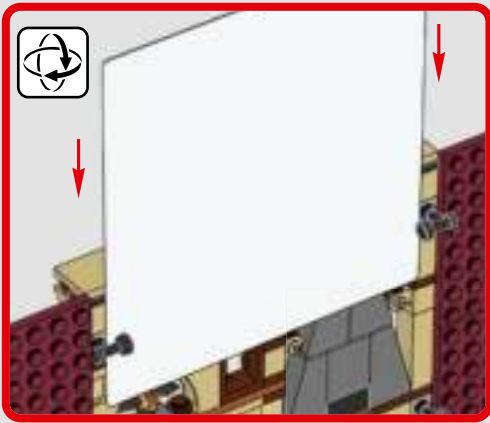

86

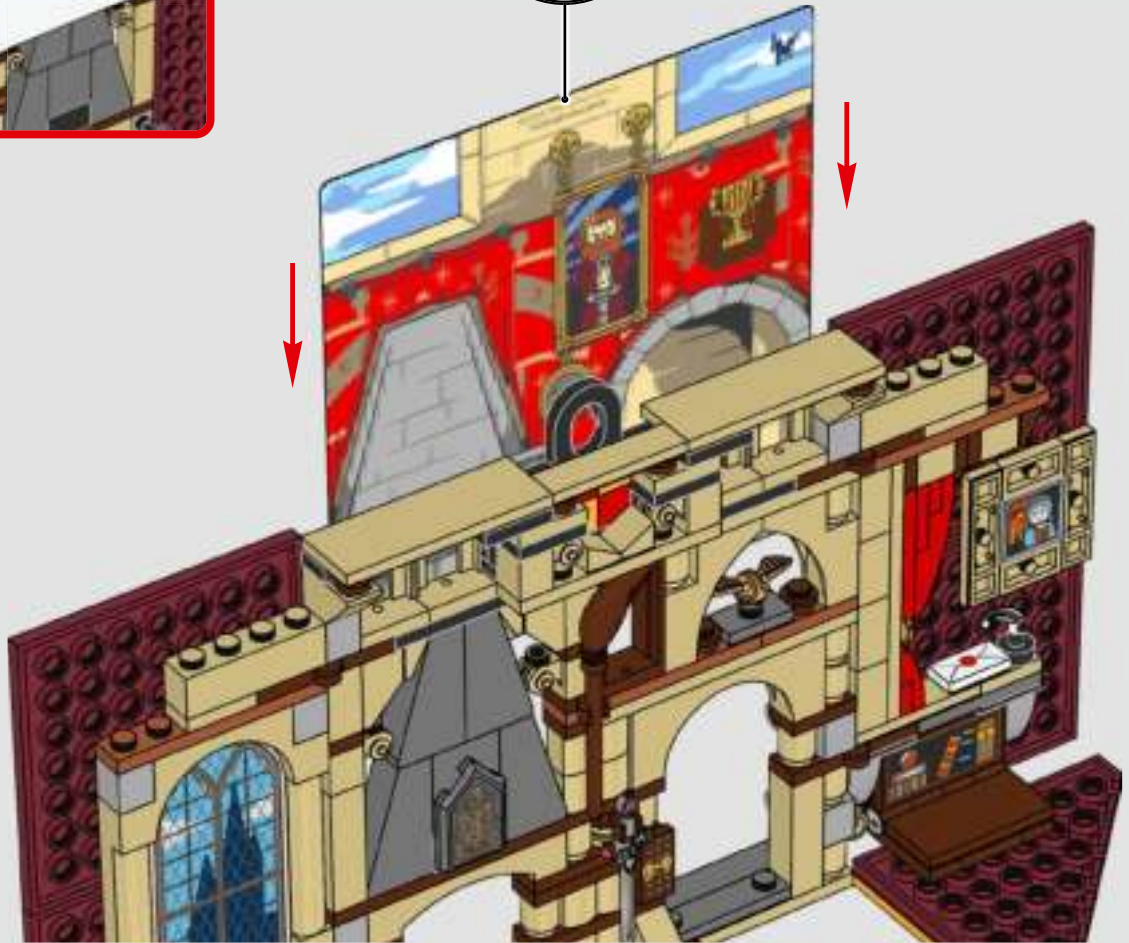
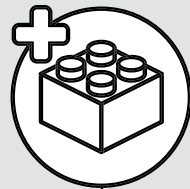

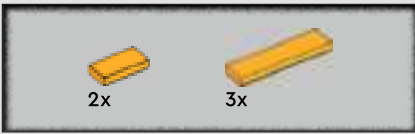

87

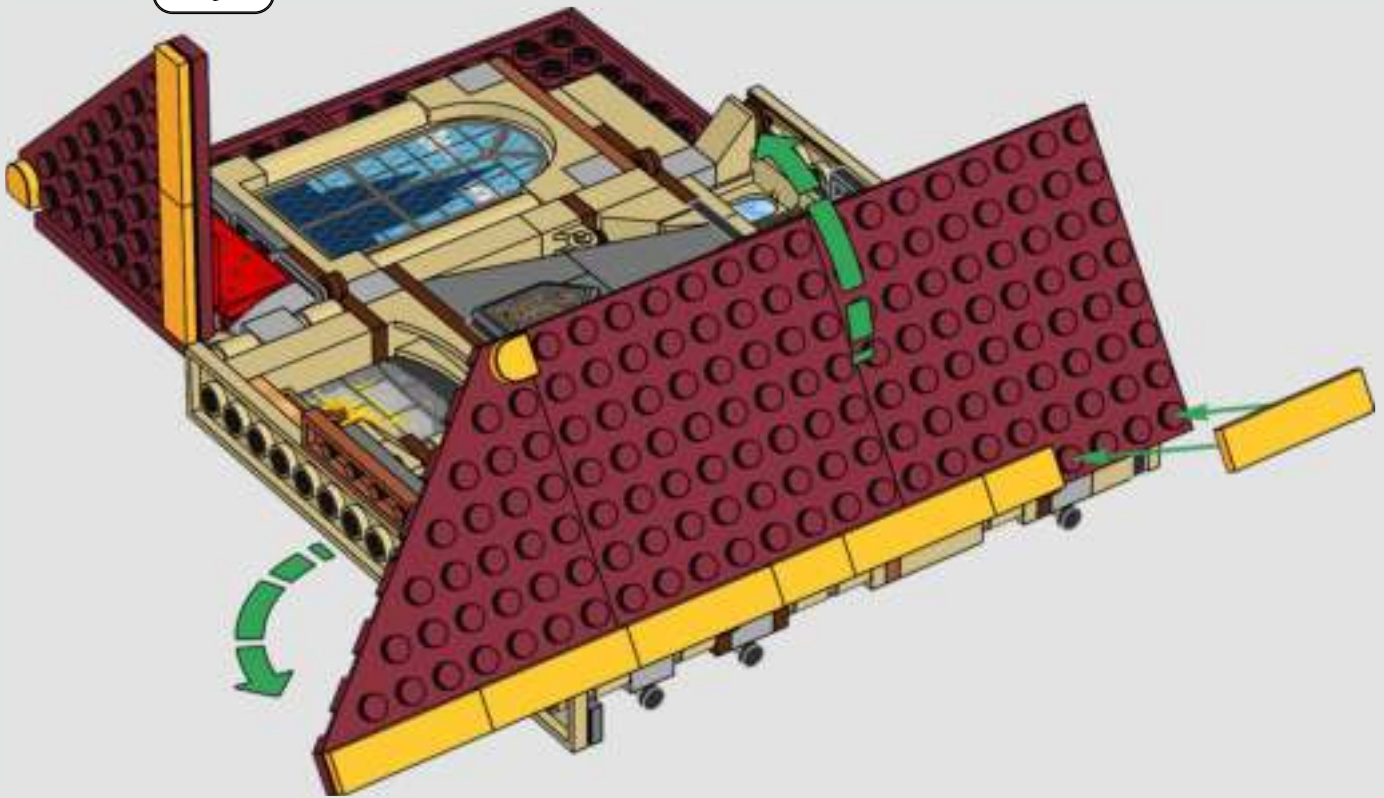

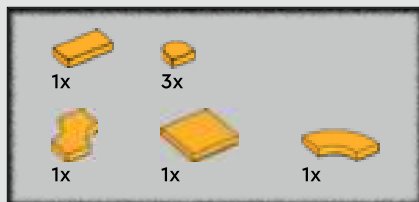

88

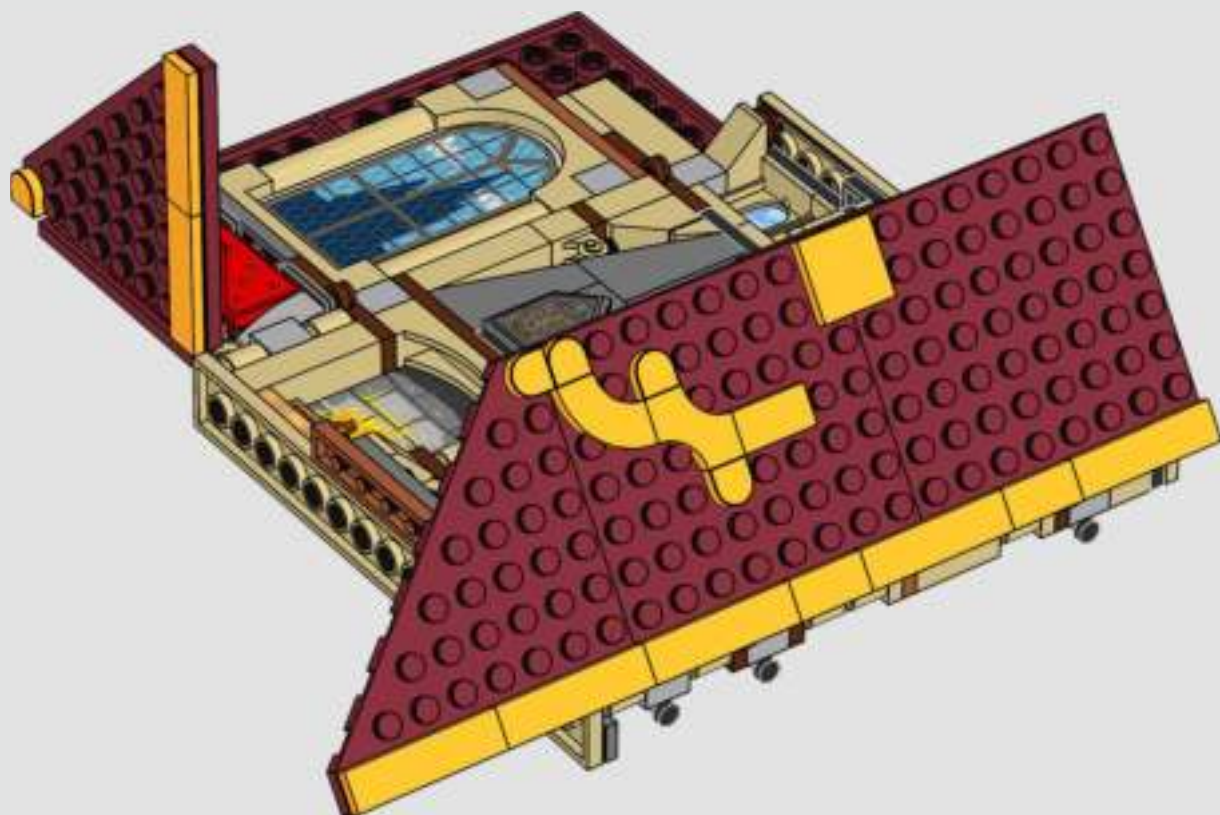

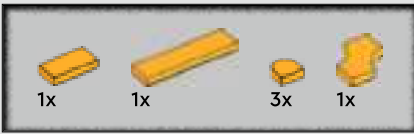

89

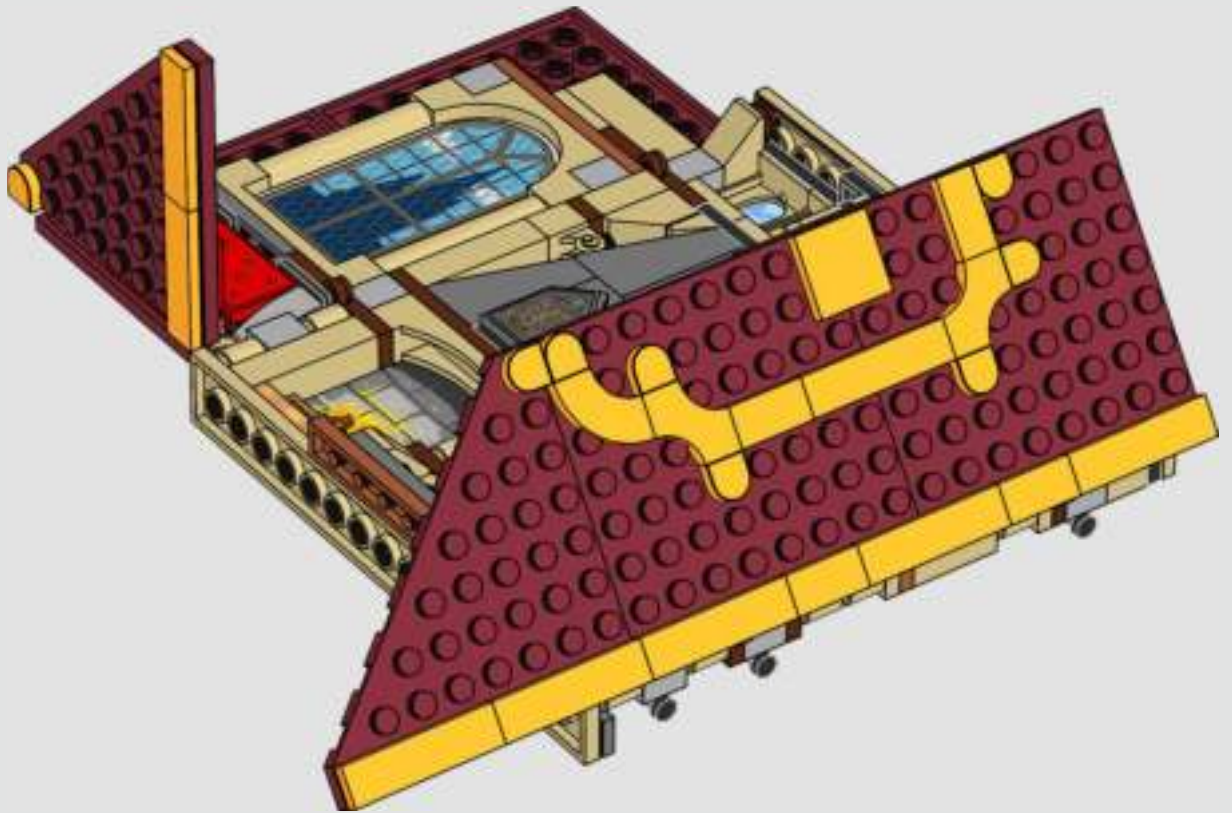



90

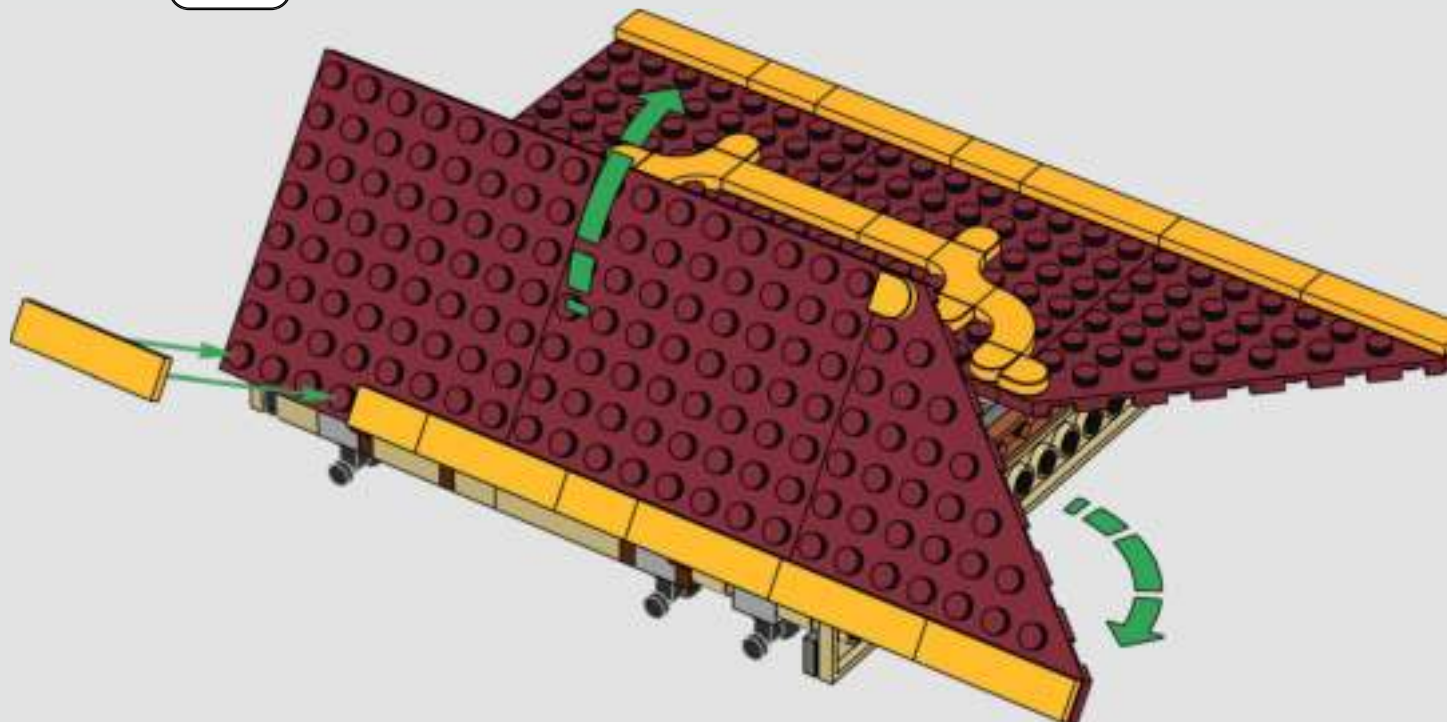

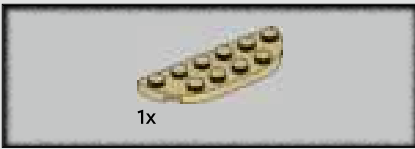

91

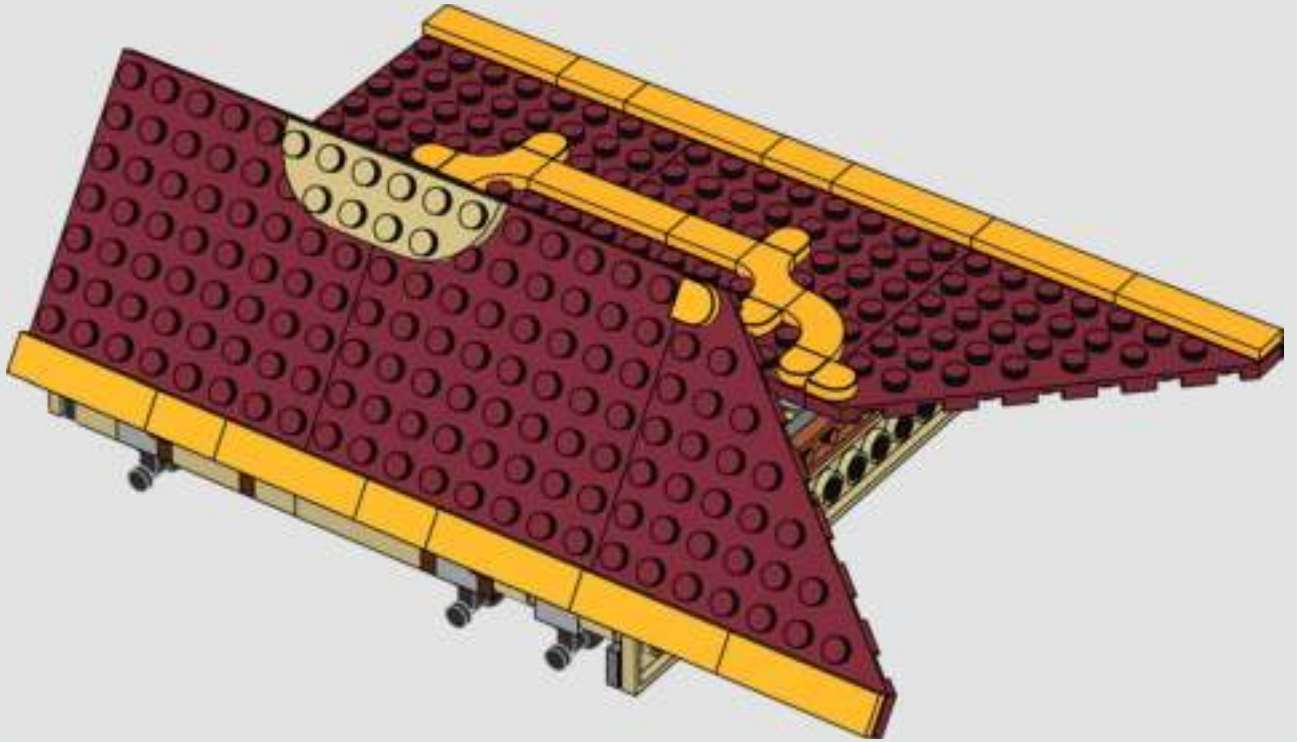

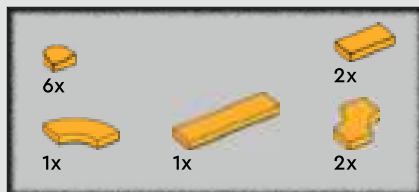

92

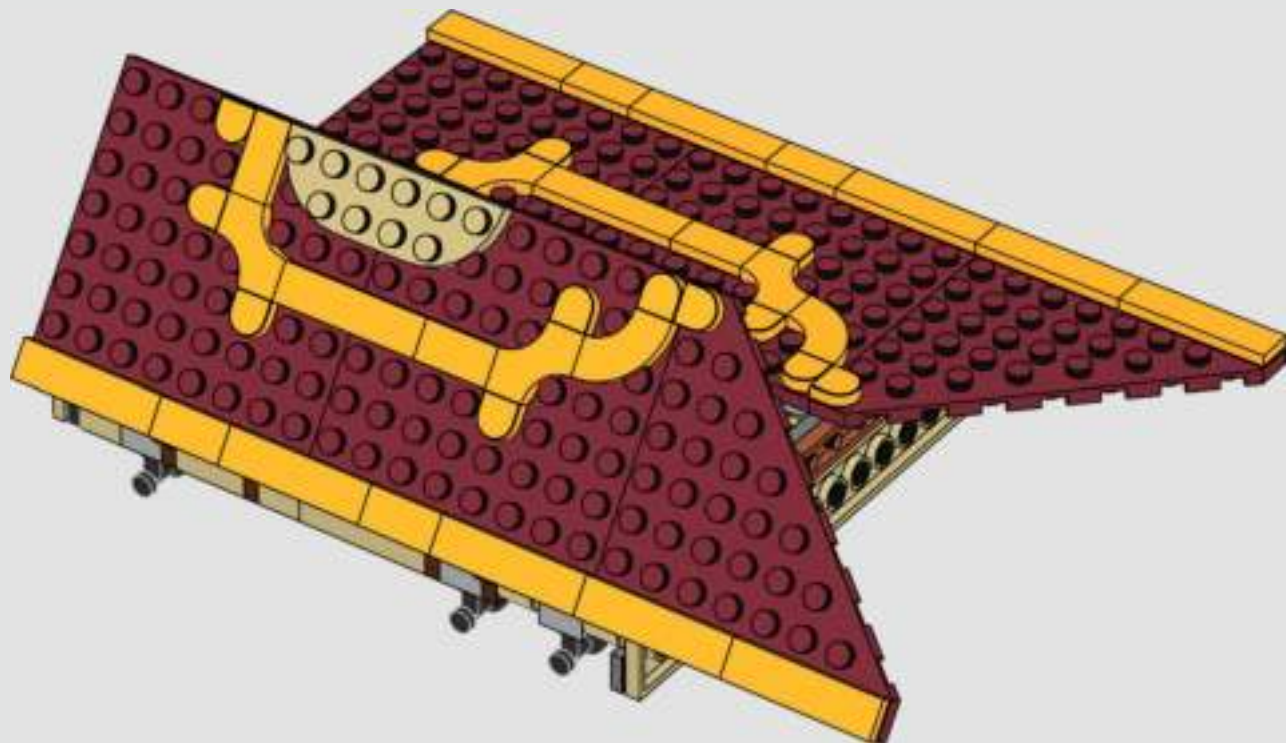





93

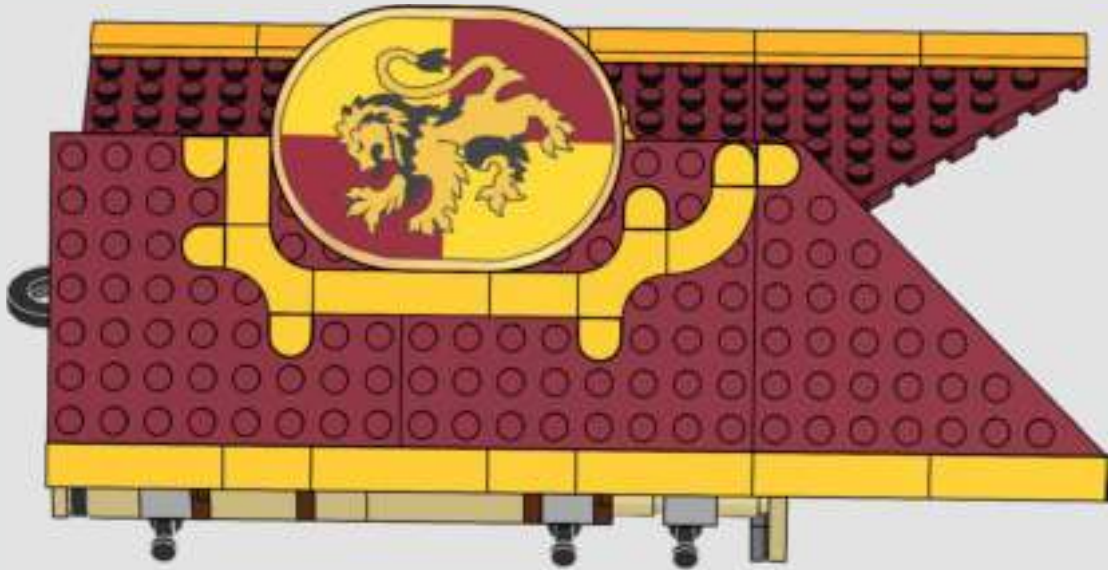

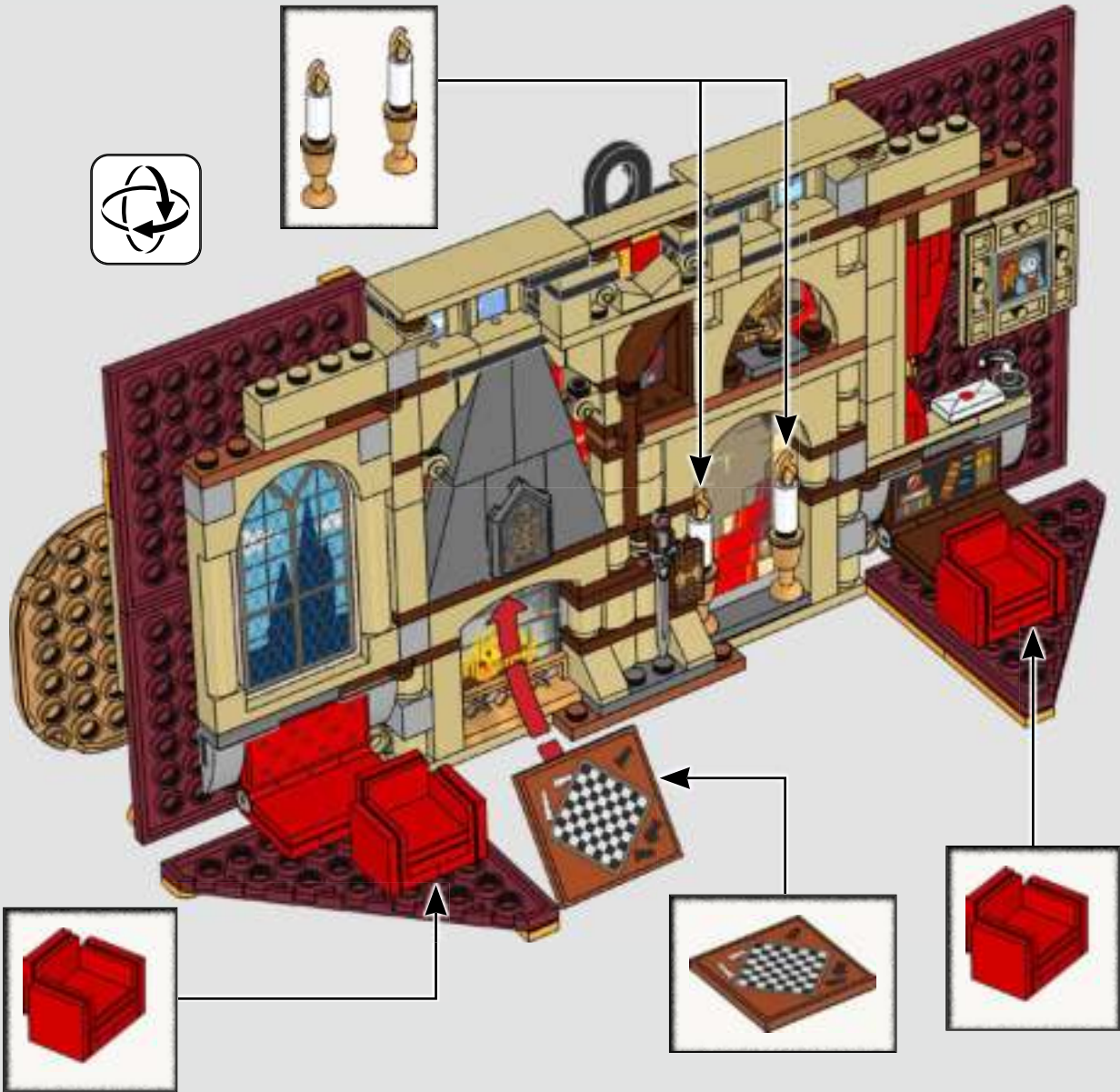

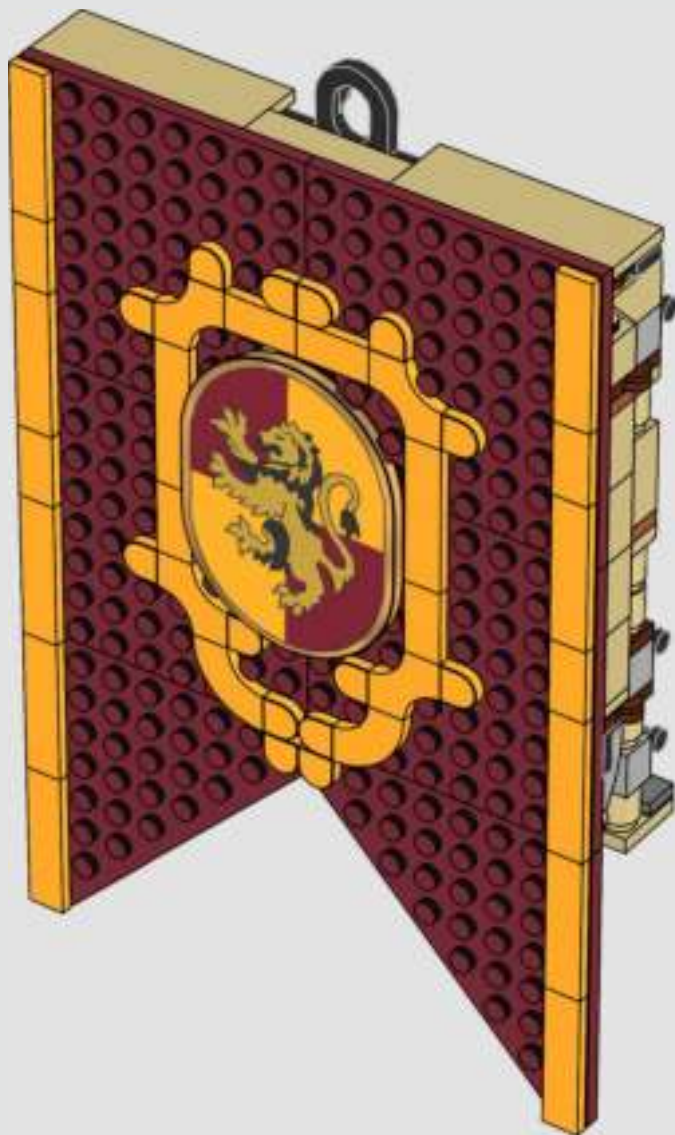







2x  
6234807



1x  
6406415



1x  
6299836



12x  
4117070



4x  
4161734



4x  
4516055



6x  
6232135



3x  
6057517



2x  
6175968



4x  
4218749



4x  
6114992



1x  
4107623



4x  
4642933



4x  
4121972



2x  
4159196



7x  
4113917



2x  
6058093



1x  
4550324



3x  
6257600



2x  
4201062



1x  
6210759



1x  
4618876



1x  
6106187



1x  
6273864



1x  
4113993



2x  
6331158



3x  
4114324



1x  
6030980



2x  
307021



2x  
302421



1x  
6029946



3x  
302321



6x  
6117974



1x  
302221



6x  
306821



2x  
6013868



4x  
6433069



1x  
371021



1x  
6045937



2x  
6433945



1x  
6186675



6x  
459926



1x  
4526110



1x  
4515122



4x  
6279875



2x  
9339



1x  
6138173



4x  
6016172



2x  
6250020



2x  
242026



2x  
6013867



1x  
6353176



2x  
371026



1x  
6429020



1x  
663626



1x  
4514845



1x  
6186007



4x  
6253418



1x  
6408240



1x  
6278080



1x  
6270031



1x  
6435051



2x  
6429024



4x  
6249819



2x  
6357747



1x  
6209681



14x  
6313554



2x  
6065504



4x  
6433937



8x  
4622062



2x  
6334203



1x  
6020147



12x  
6072668



1x  
4211150



1x  
6139435



10x  
4216581



1x  
6435952



6x  
4221744



1x  
4504376



2x  
6337003



1x  
6268855



1x  
6270028



1x  
6058084



1x  
4216695



4x  
6415991



3x  
4211190



4x  
6416695



2x  
6433946



1x  
4223683



9x  
4558953



4x  
6144138



1x  
4210978



4x  
4221745



1x  
6092572



1x  
6435038



1x  
6335316



1x  
6257592



2x  
4211001



1x  
4211065



2x  
4211008



1x  
6299870



1x  
6265371



1x  
4536675



2x  
4505990



2x  
6190252



1x  
6342678



1x  
6432014



1x  
6420340



1x  
6270032



1x  
4535553



1x  
6306750



 [LEGO.com/service](https://www.LEGO.com/service)

YOU COULD

WIN



Scan this QR code or go to  
**LEGO.COM/PRODUCTFEEDBACK** and give us  
your short feedback about this LEGO® set for a  
chance to win a cool LEGO prize.

Terms and Conditions apply\*

**DE: Du könntest GEWINNEN.** Es gelten die Teilnahmebedingungen\* **FR: Tu pourrais GAGNER.** Des conditions s'appliquent\* **IT: Potresti VINCERE tu.** Termini e condizioni sono applicabili\* **ES: Puedes GANAR.** Aplican términos y condiciones\* **PT: Poderá GANHAR.** Aplicam-se termos e condições\* **JA: プレゼント付き! 利用規約が適用されます\*** **ZH: 轻松获奖. 条款和条件适用\*** **KO: 상품의 주인이 되어보세요. 소정의 약관이 적용됩니다\*** **RU: Вы можете ВЫИГРАТЬ.** Действуют положения и условия\* **PL: Szansa na WYGRANĄ.** Obowiązują warunki korzystania\* **CS: Máte šanci VYHRÁT.** Platí všeobecné smluvní podmínky\* **SK: Máte šancu VYHRAŤ.** Platia všeobecné zmluvné podmienky\* **HU: TE IS NYERHETSZ.** Felhasználási feltételek érvényesek\* **RO: Ai putea CÂȘTIGA.** Se aplică termeni și condiții\* **BG: Можете да СПЕЧЕЛИТЕ.** Има определени правила и условия\* **LV: Tu vari LAIMĒT.** Ir spēkā noteikumi un nosacījumi.\* **ET: Sul on võimalus VÕITA.** Kehtivad tingimused\* **LT: Jūs galite LAIMĖTI.** Taikomos sąlygos\*  
\*LEGO.com/productfeedback-terms

LEGO and the LEGO logo are trademarks of the LEGO Group. ©2023 The LEGO Group.

WIZARDING WORLD and all related trademarks, characters, names, and indicia are © & ™ Warner Bros. Entertainment Inc.  
Publishing Rights © JKR. (s23)