



# Harry Potter



76410





[LEGO.com/sustainable-packaging](https://LEGO.com/sustainable-packaging)



# BUILDER



Apple and the Apple logo are trademarks of Apple Inc., registered in the U.S. and other countries and regions. App Store is a service mark of Apple Inc. Google Play and the Google Play logo are trademarks of Google LLC. Tencent and the Tencent logo are trademarks of Tencent Inc.

Q [LEGO.com/devicecheck](https://www.lego.com/devicecheck)

EN Ask parents' permission before going online | DE Eltern um Erlaubnis bitten, bevor du online gehst | FR Demande l'autorisation d'un parent avant d'aller en ligne | IT Chiedi il permesso ai tuoi genitori prima di andare online | ES Pídeles permiso a tus papás antes de conectarte a Internet | PT Peça autorização aos pais antes de acederes online | JA オンラインになる前にほご者の方のきよかをもらおう | ZH 上网前应先征得父母的同意 | KO 온라인 접속 전에 보호자 동의가 필요합니다 | RU Спроси разрешения у родителей, прежде чем заходить в интернет | PL Poproś rodziców o zgodę, zanim wejdiesz do Internetu | CS Než půjdeš na internet, požádej rodiče o svolení | SK Skôr než pôjdeš na internet, vypýtaj si povolenie od rodičov | HU Kérj szülői engedélyt, mielőtt online csatlakoznál! | RO Cere permisiunea părinților înainte de a te conecta online | BG Поискайте разрешение от родител, преди да влезете онлайн | LV Pirms došanās tiešsaistē palūdz atļauju vecākiem | ET Enne Interneti kasutamist küsi vanematelt luba | LT Prieš prisijungdami prie interneto, atsiklauskite tėvų

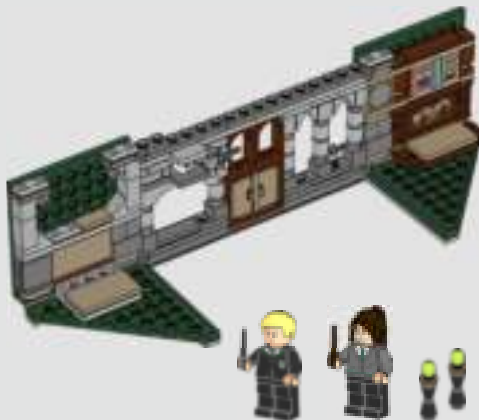

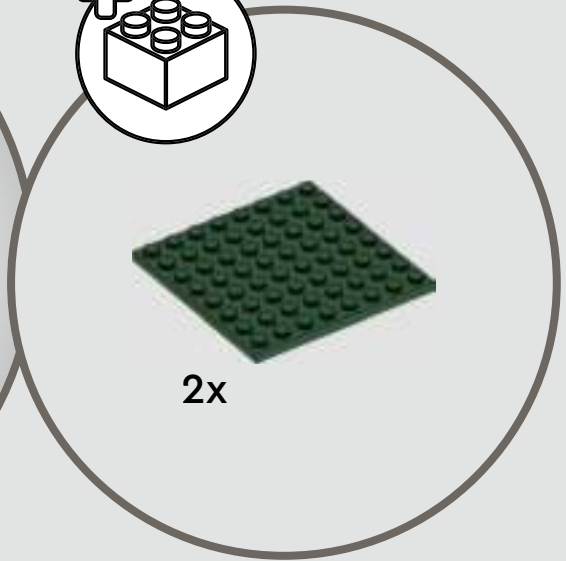
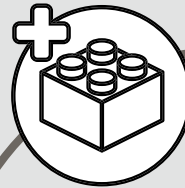



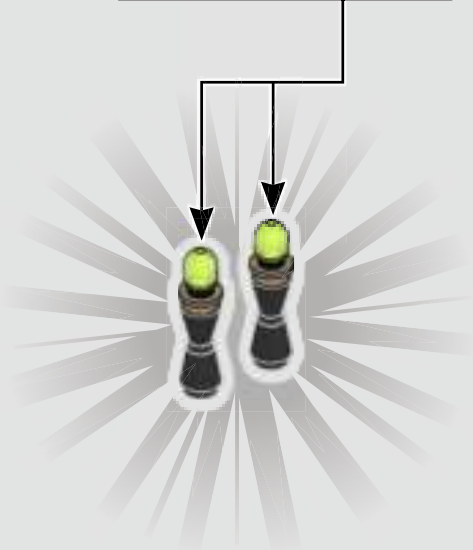

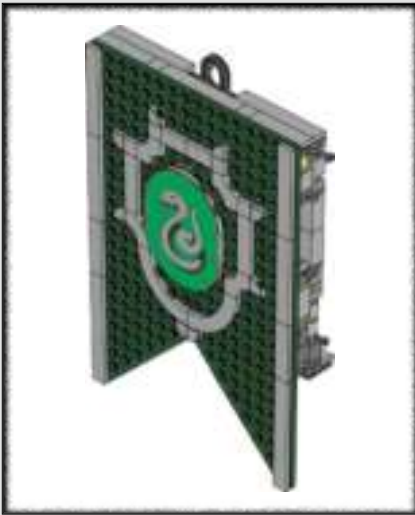

1

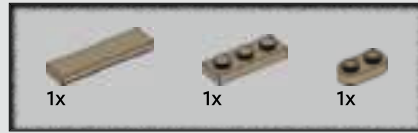

2

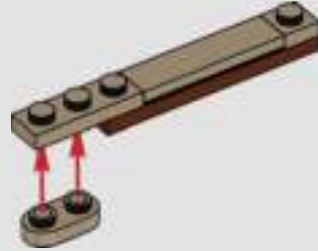

3

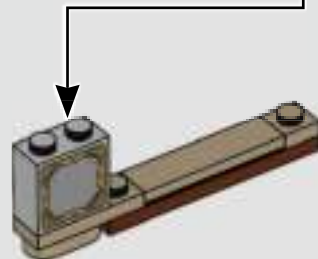
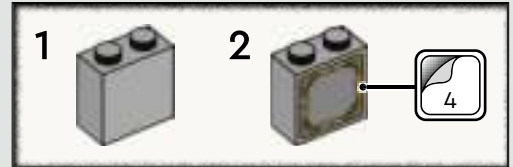



4

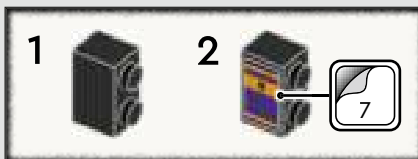





5



6



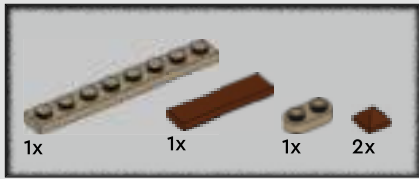

7

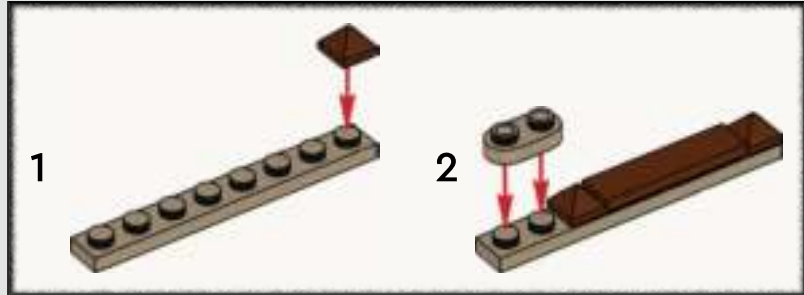



8

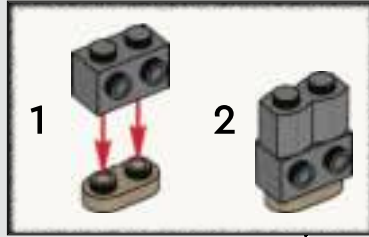

9

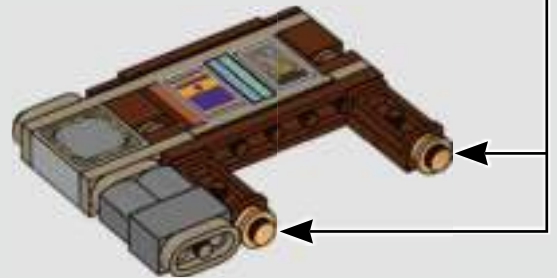
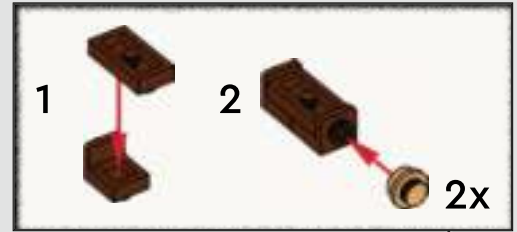



10



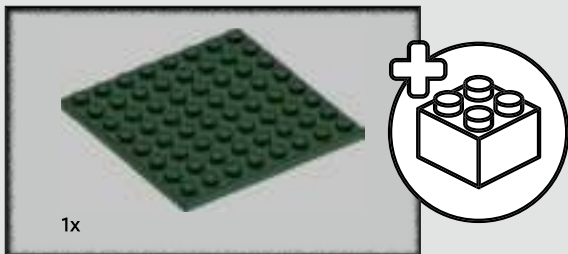

11



12

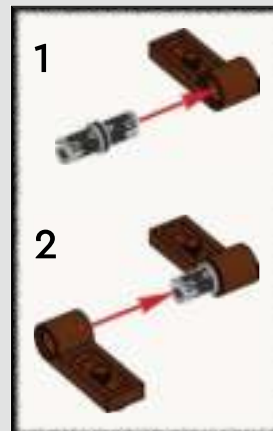



13

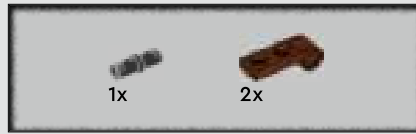
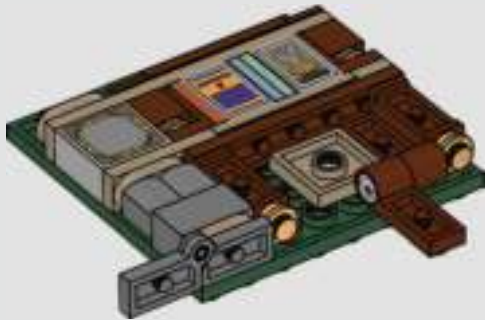

14

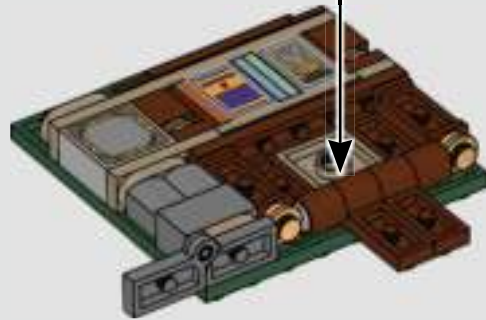
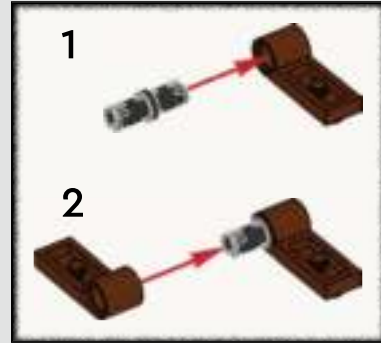





15

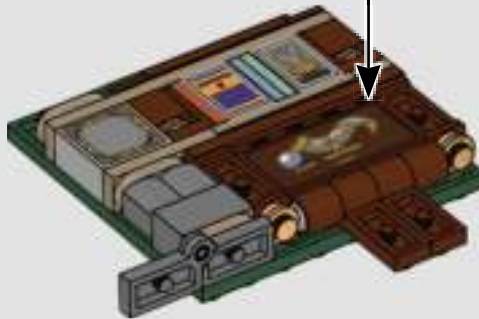

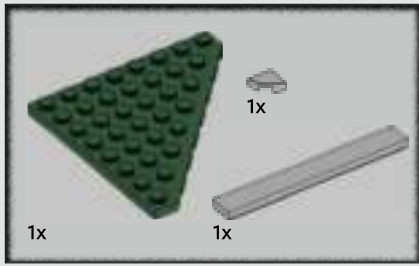

16

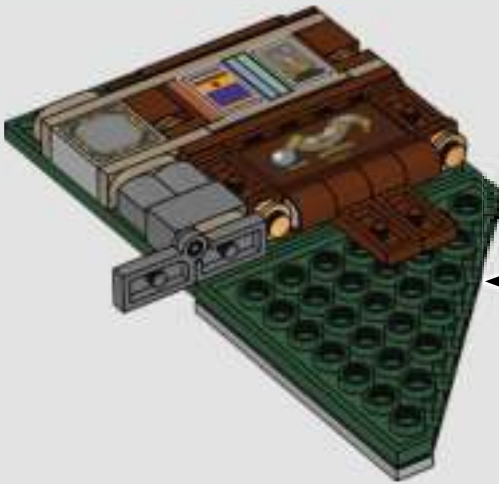
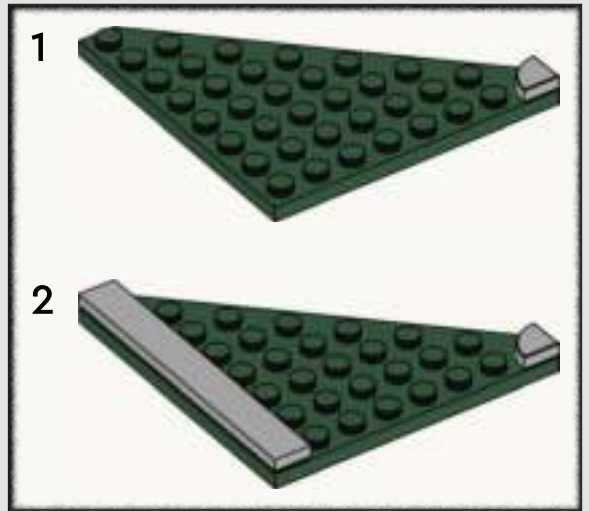

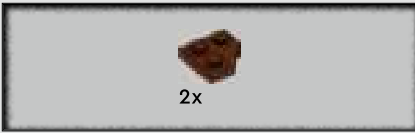

17

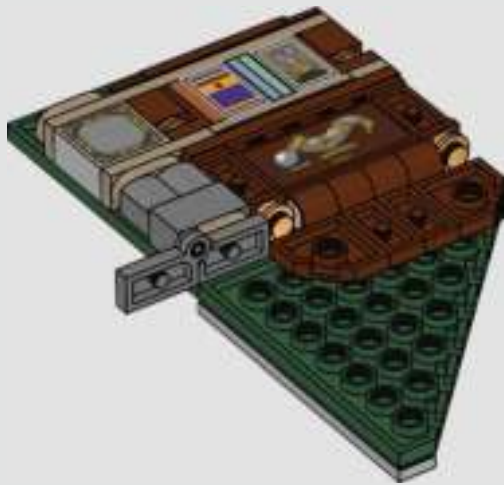



18

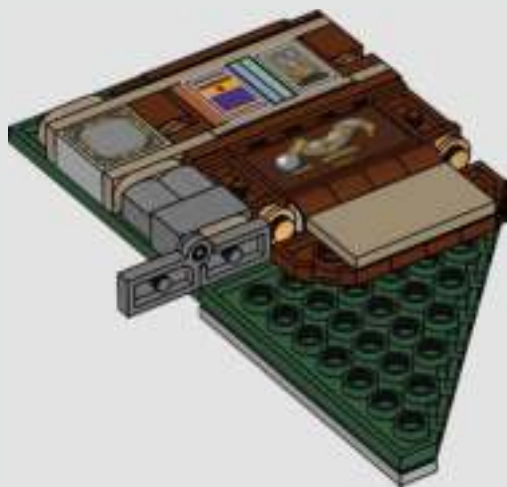

19



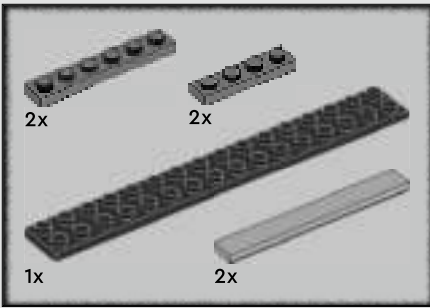

20

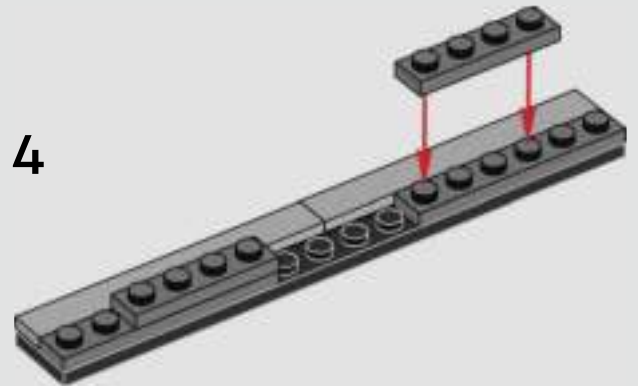
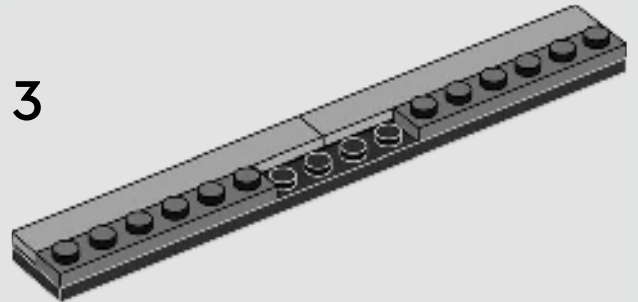
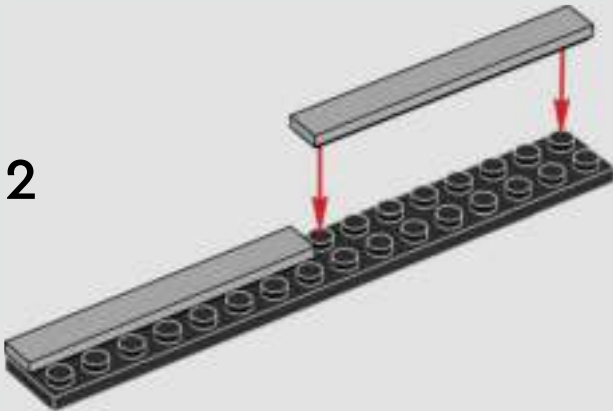
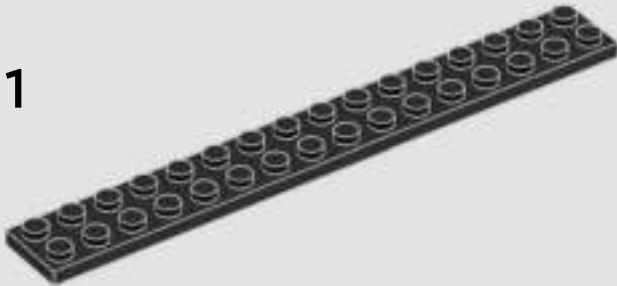

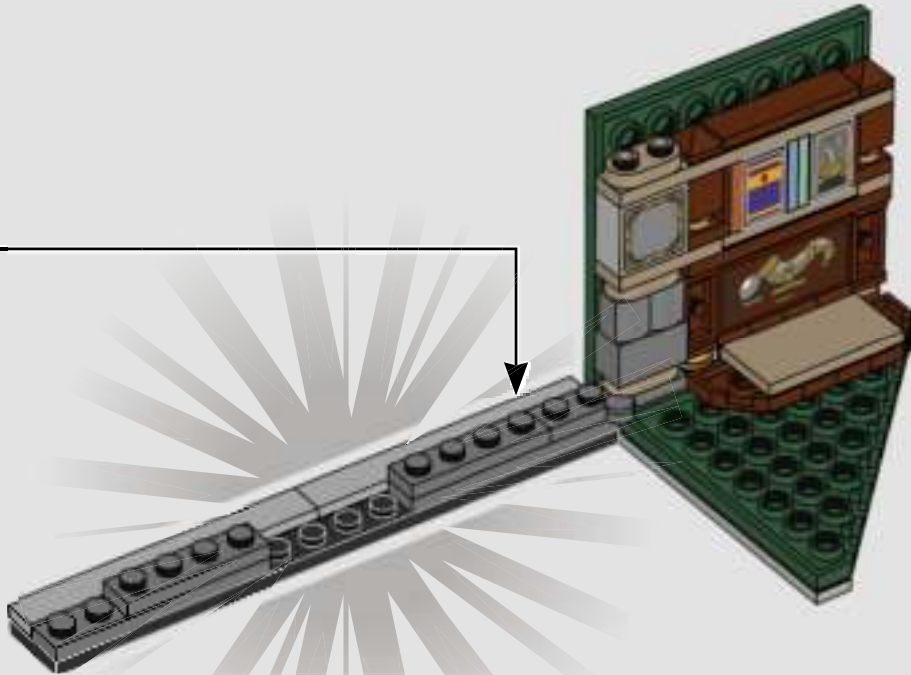



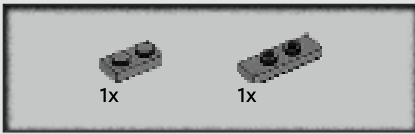

22

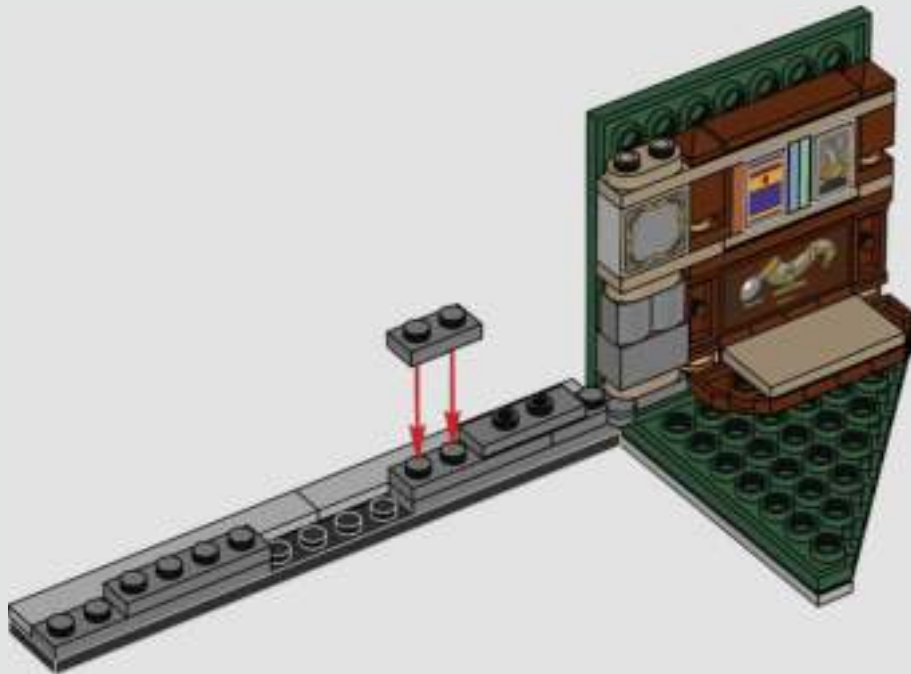

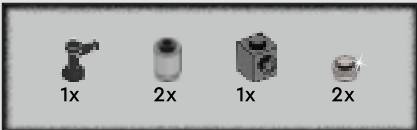

# 23

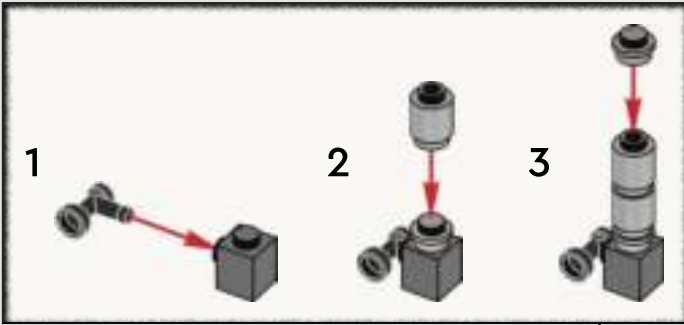



24

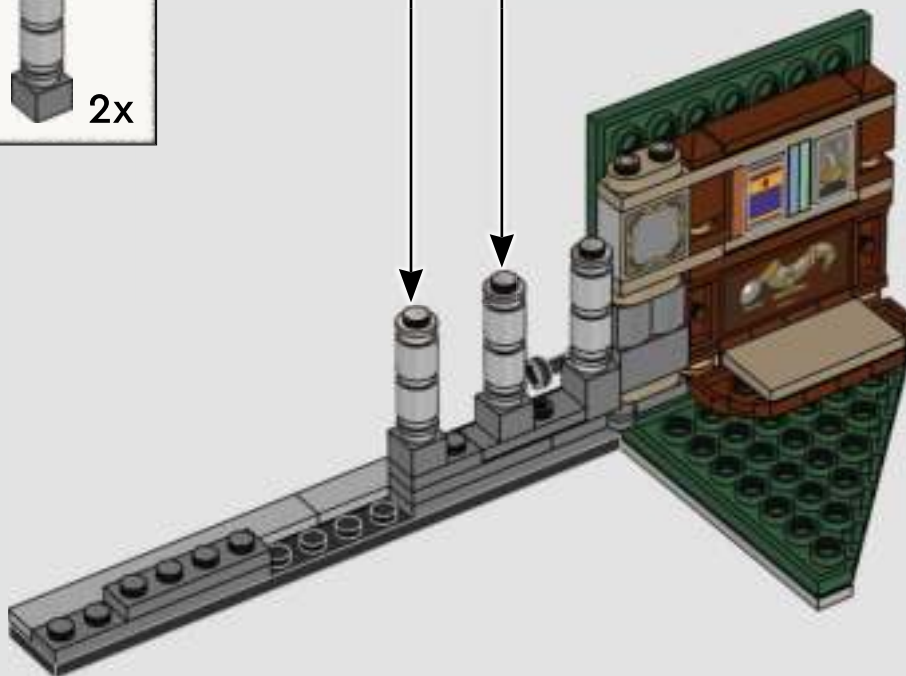
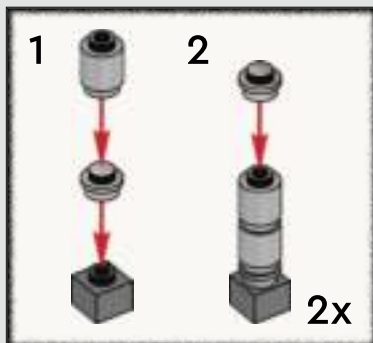

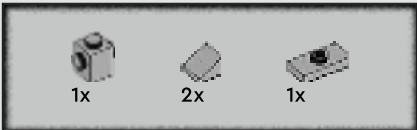

# 25

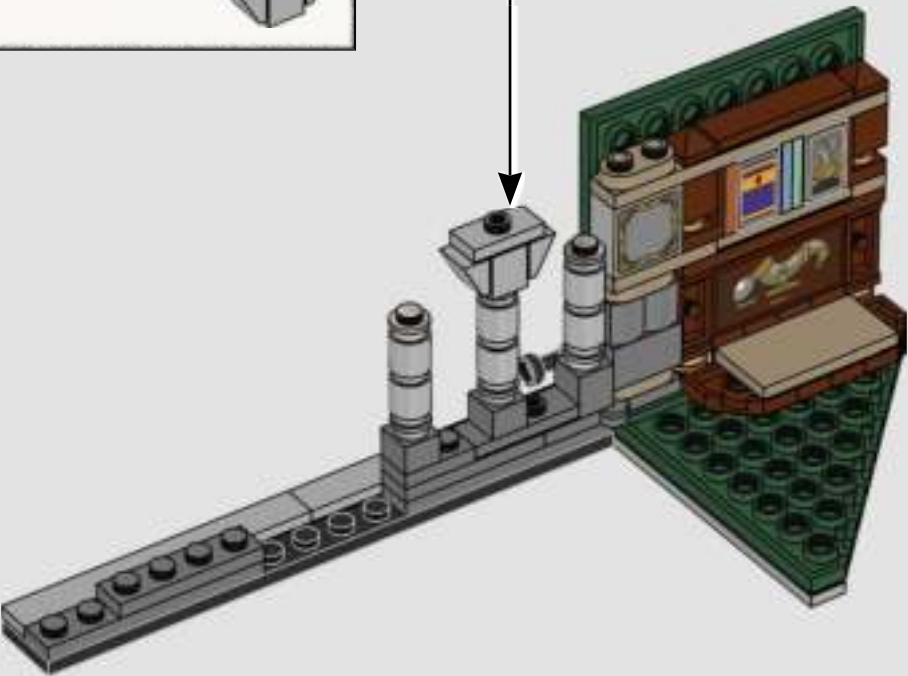
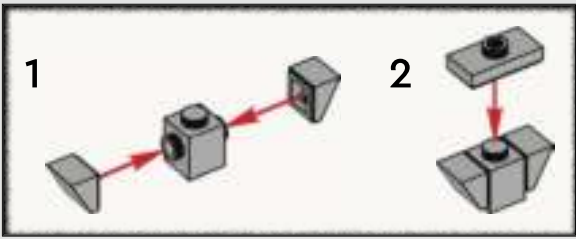

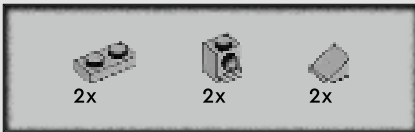

26

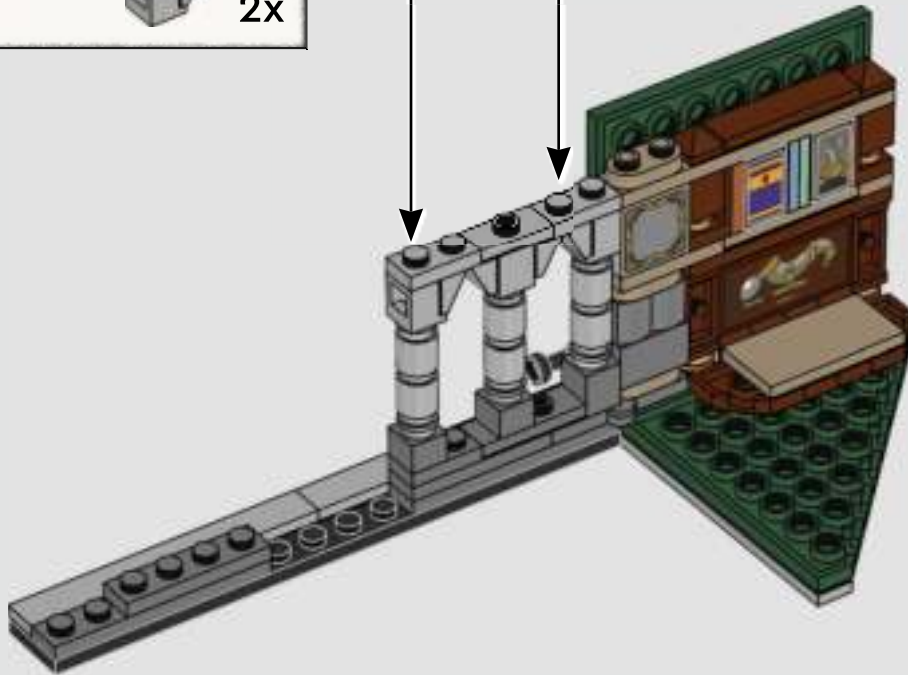
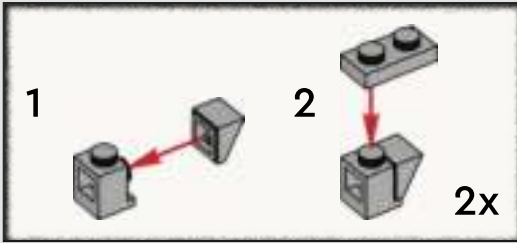

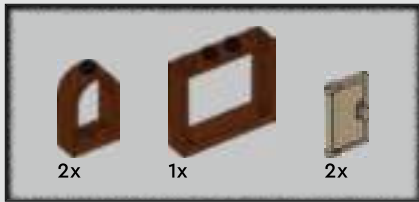

27

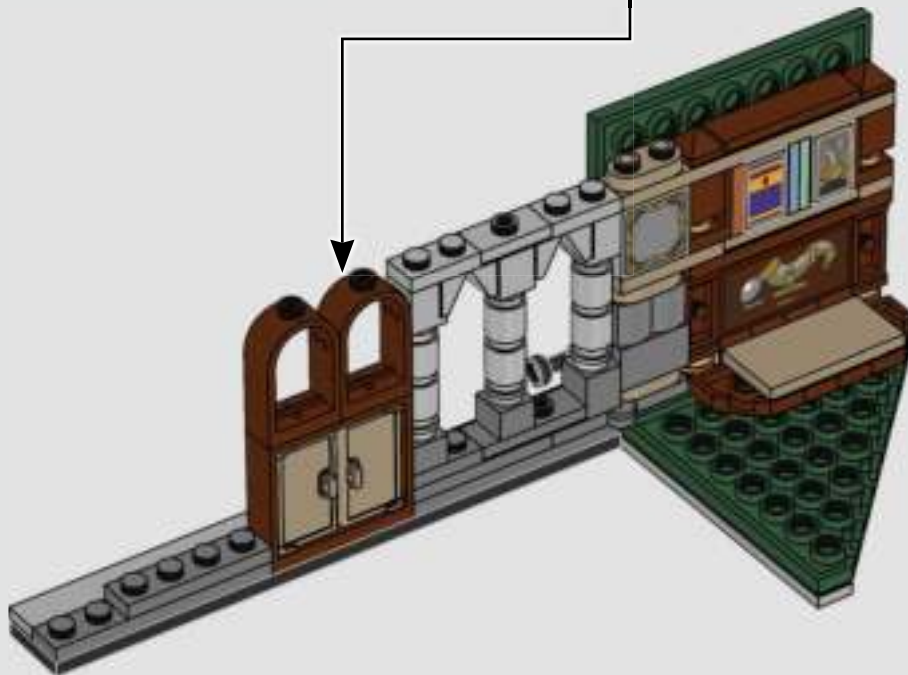
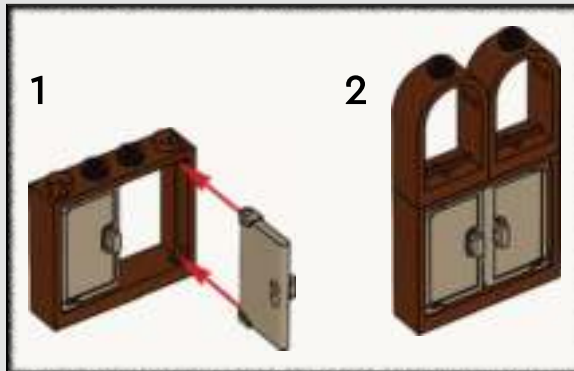



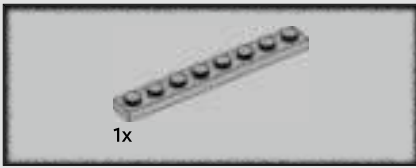

28



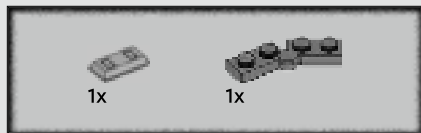

29

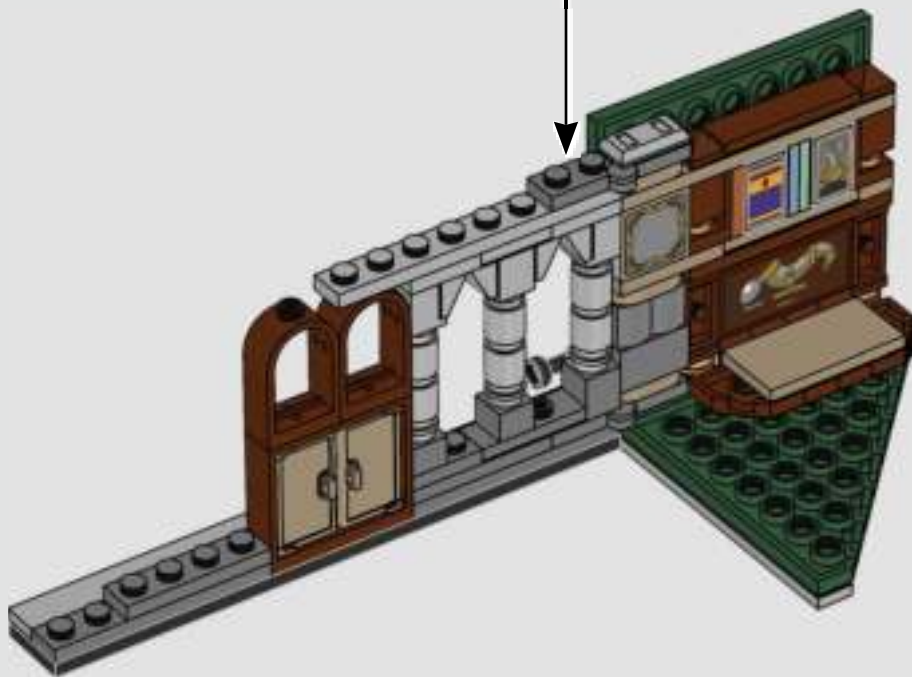
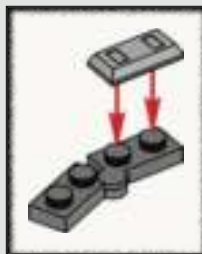

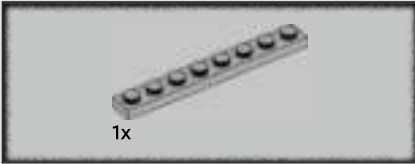

30

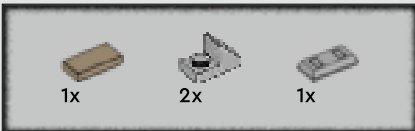
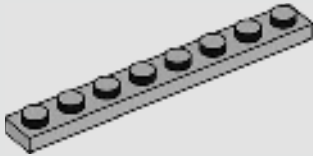

31

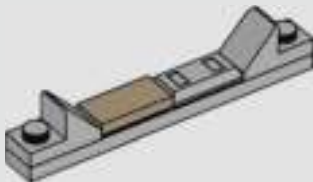

32

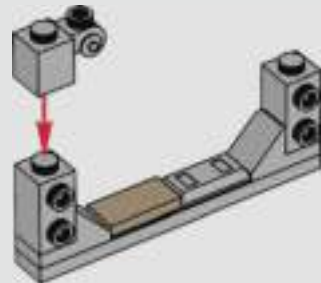

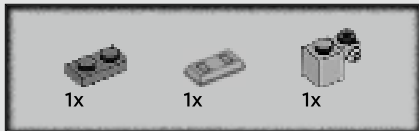

33

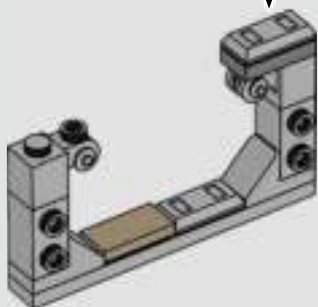
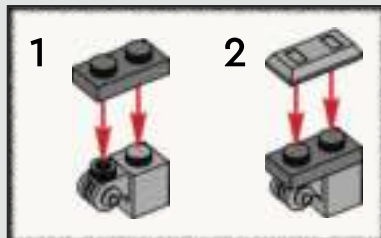

34

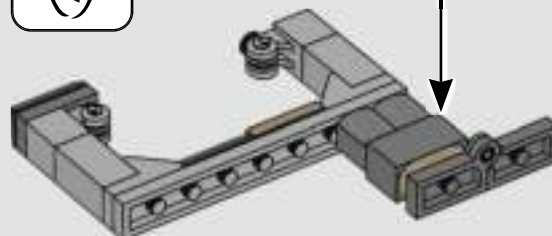
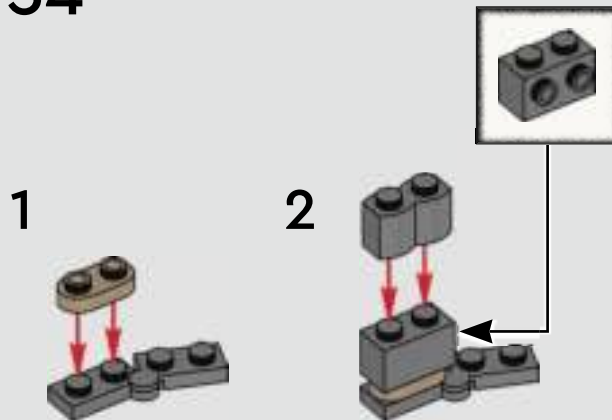

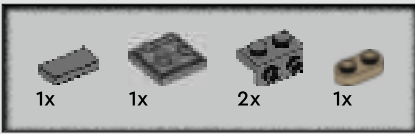

35

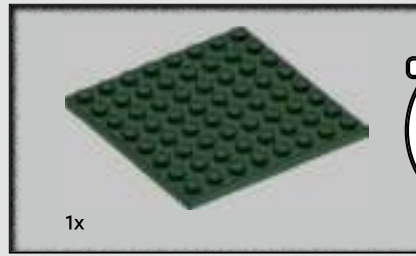
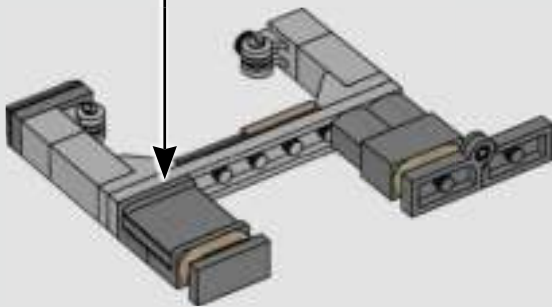
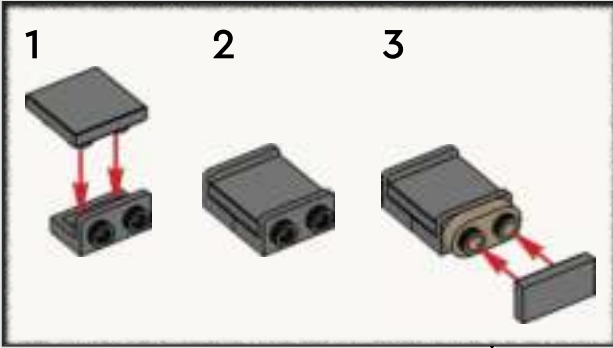

36

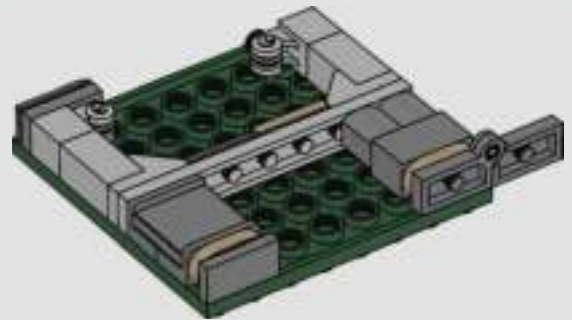
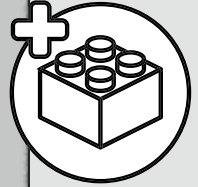



37

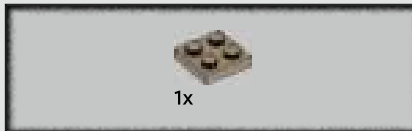
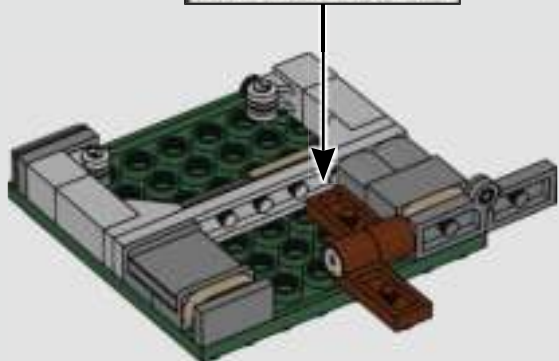
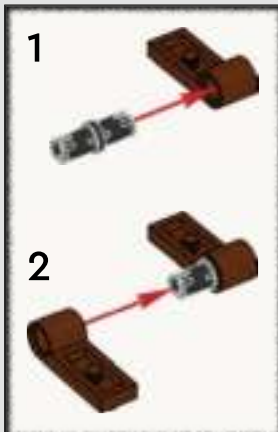

38

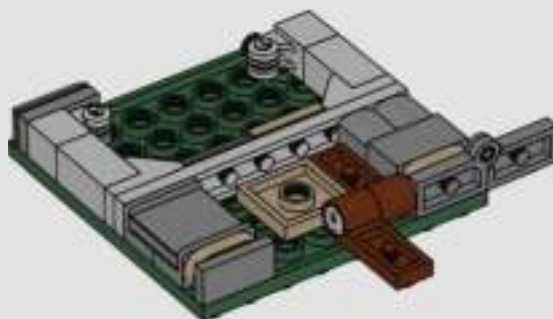



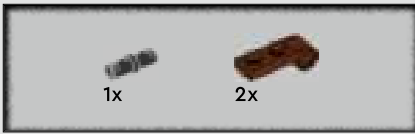

39

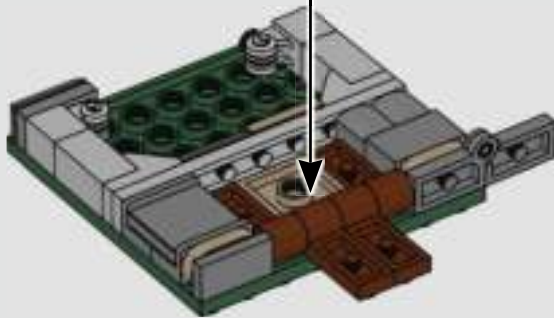
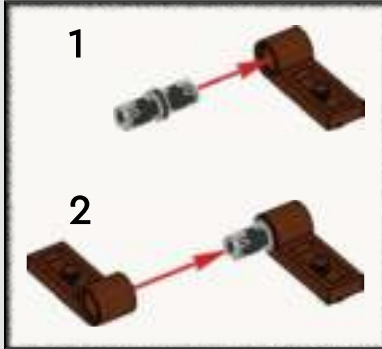

40

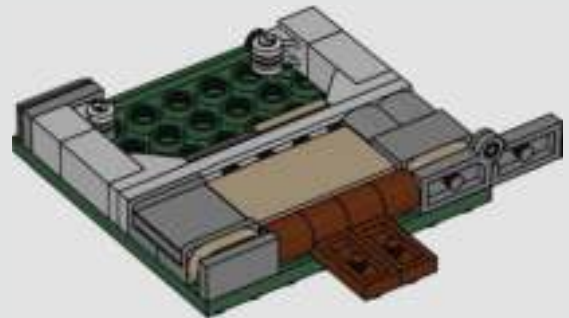

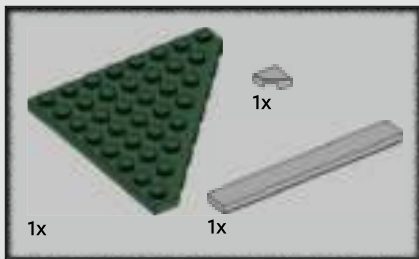

41

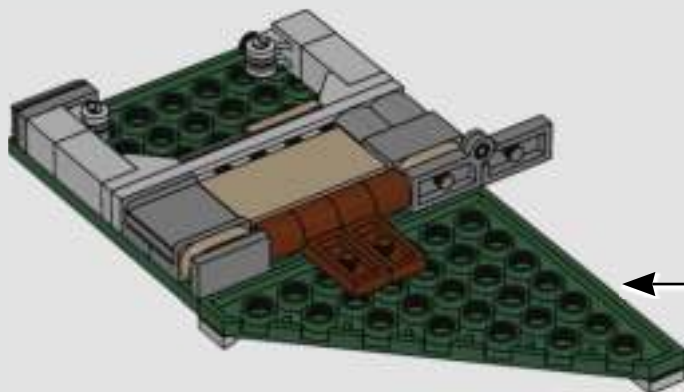
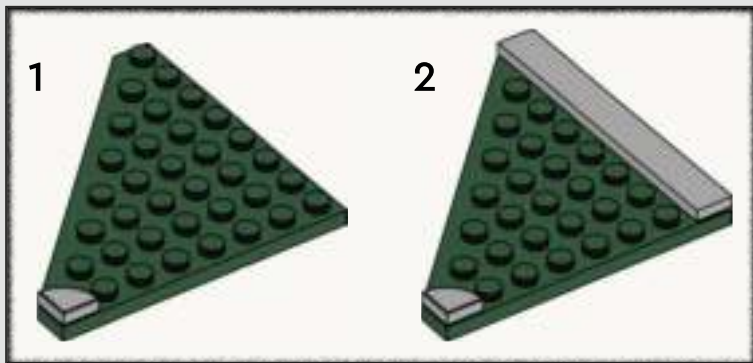



42

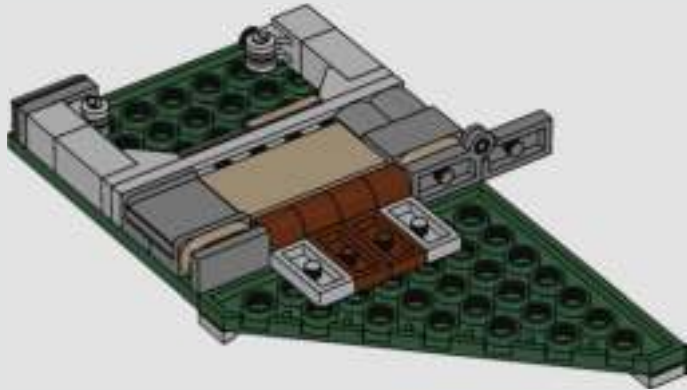

43

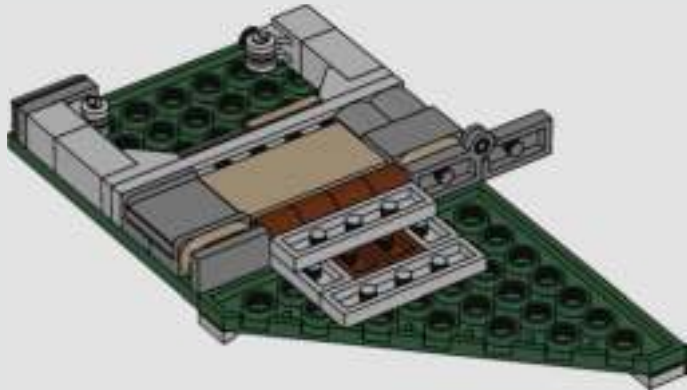



44

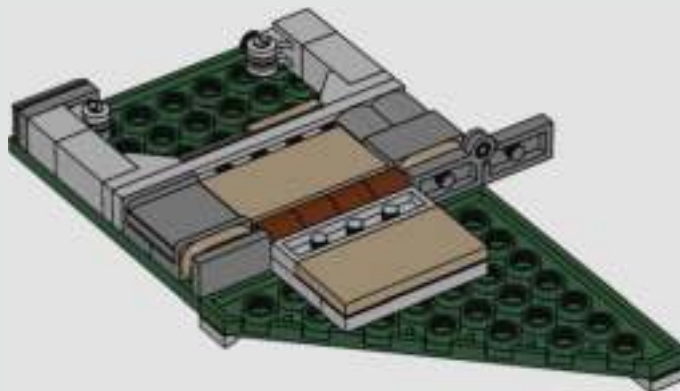

45

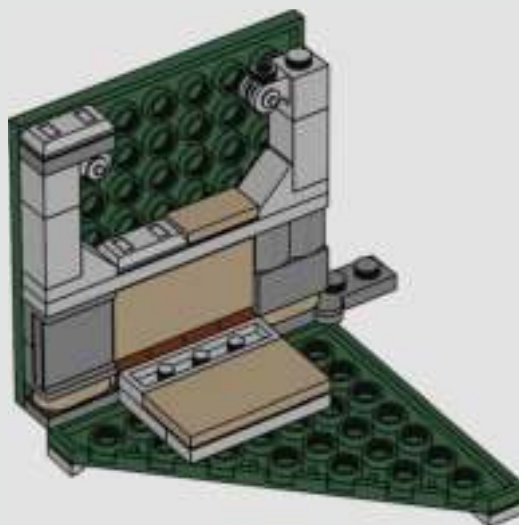

46

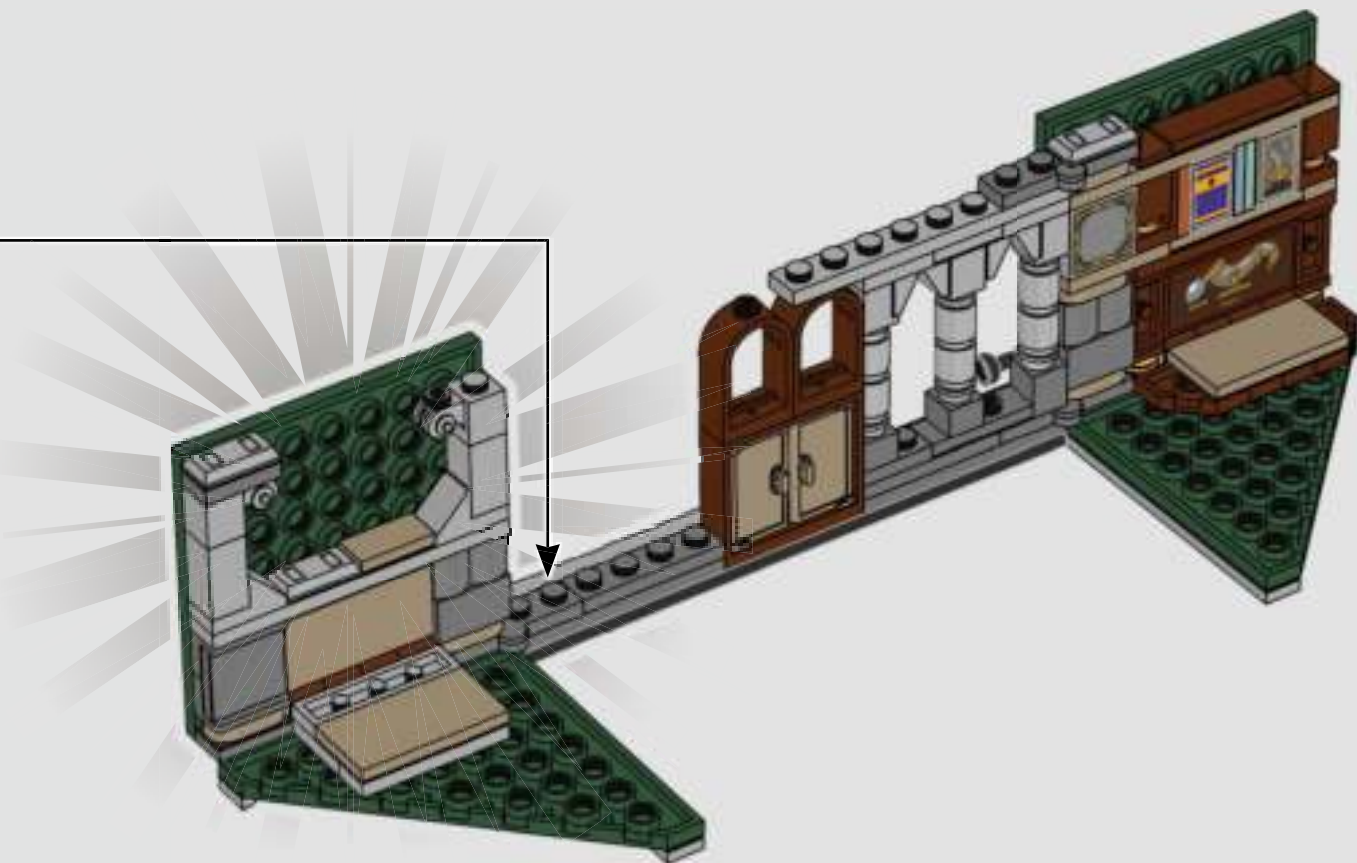

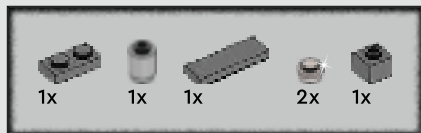

47

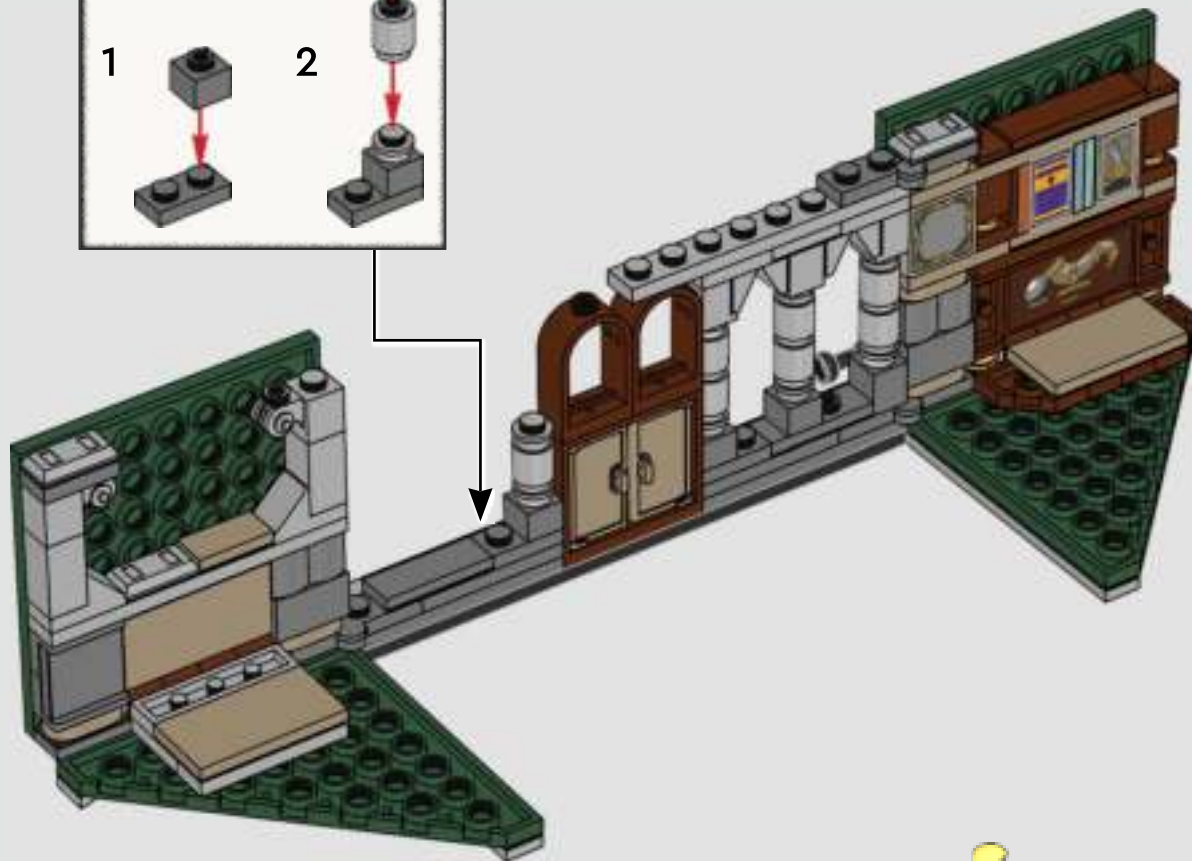
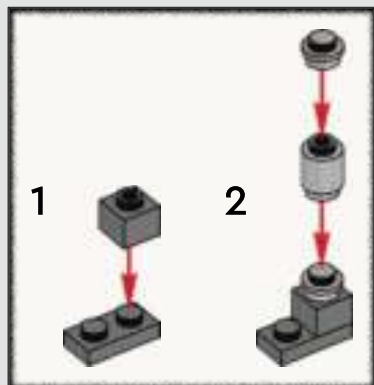

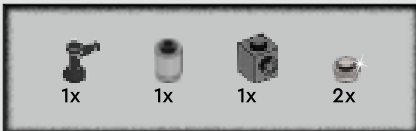

48

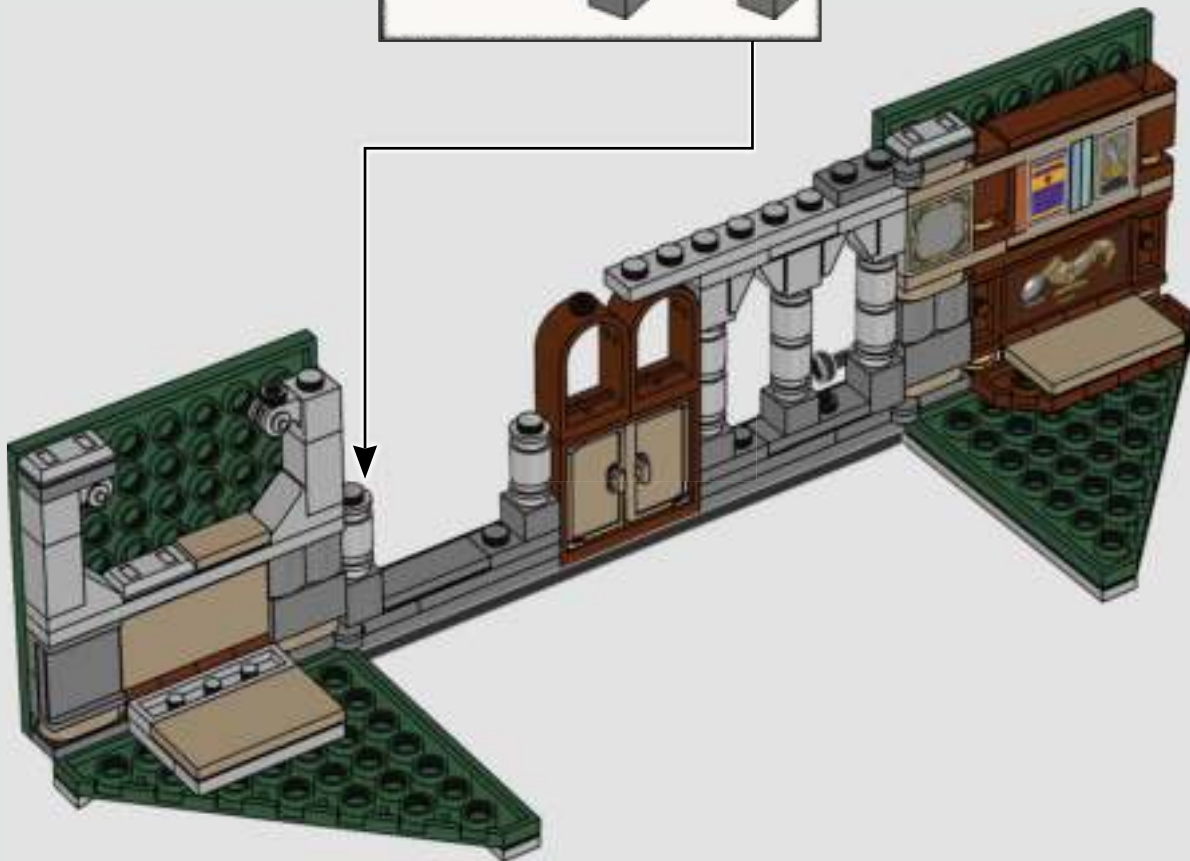
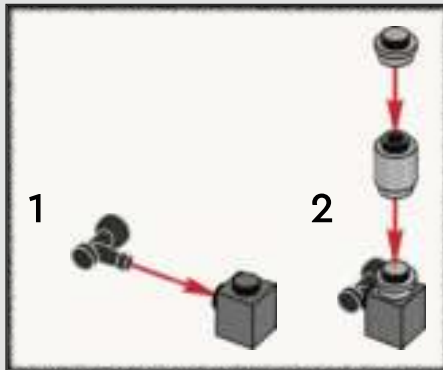





49

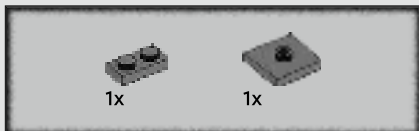
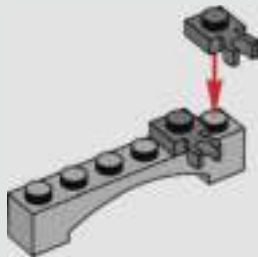

50

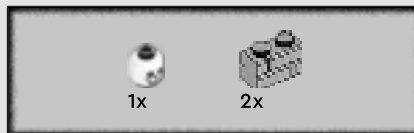
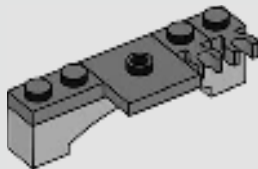

51

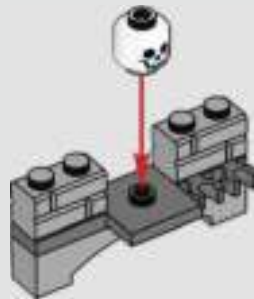

52

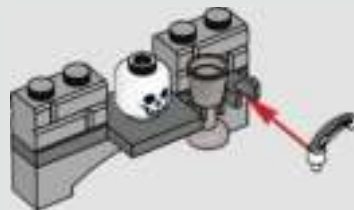





53

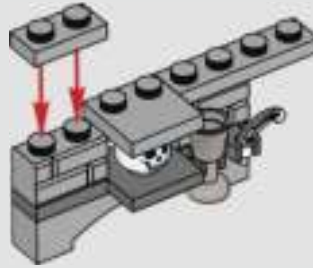

54

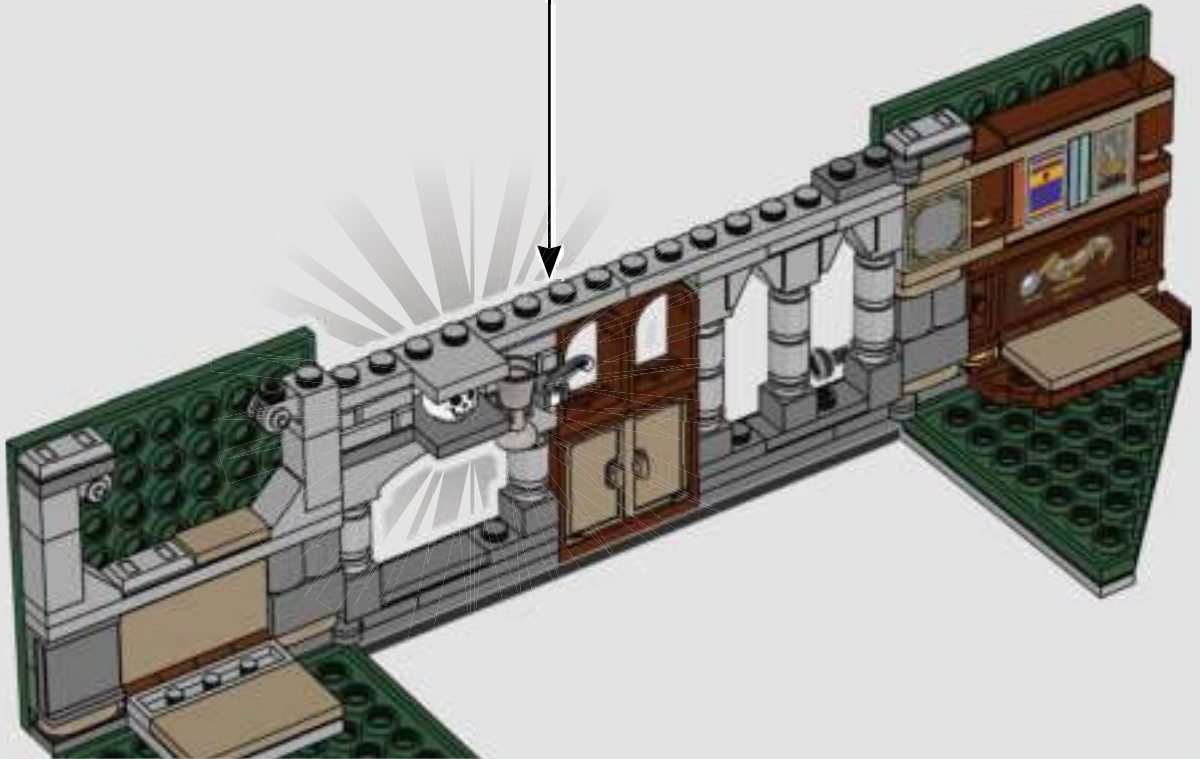

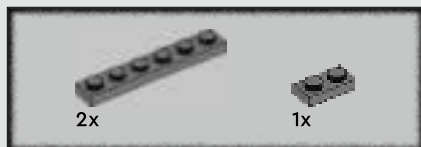

55

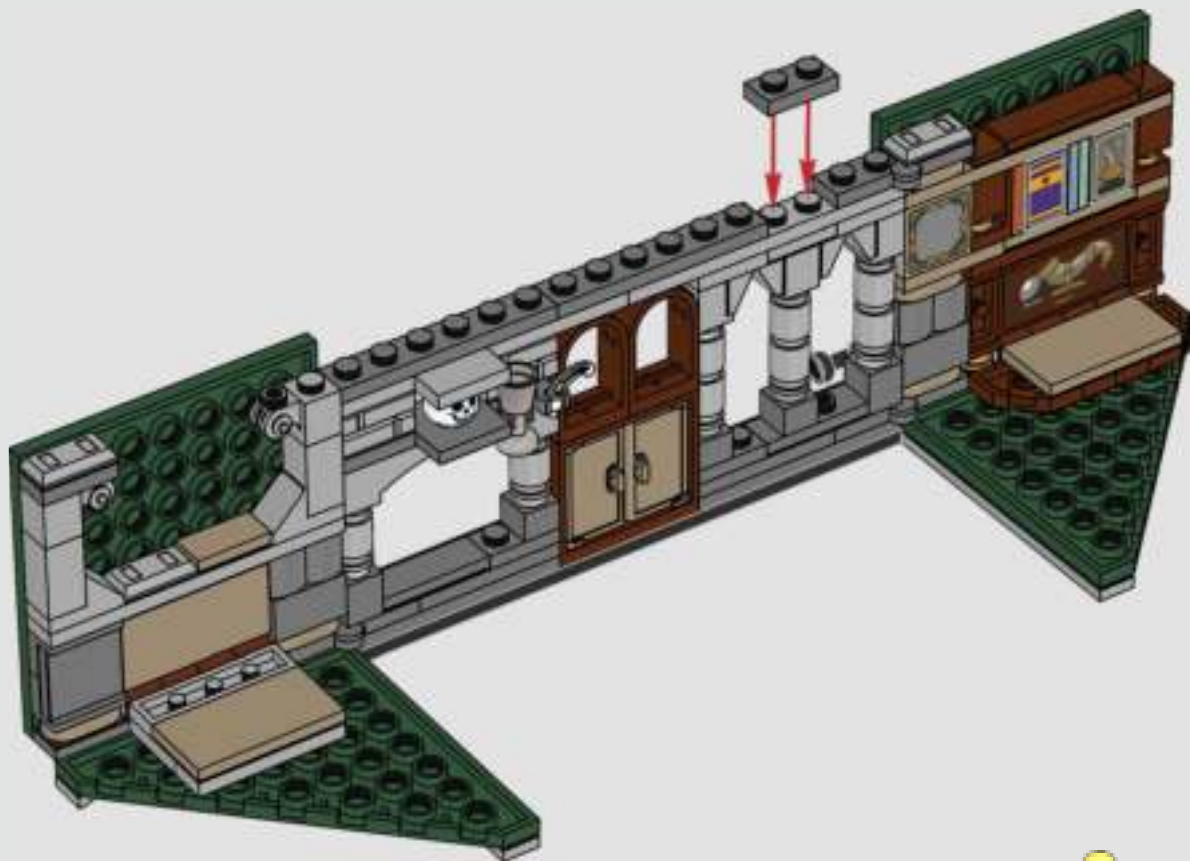

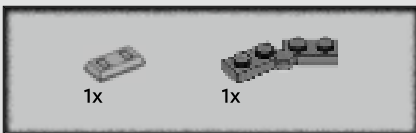

56

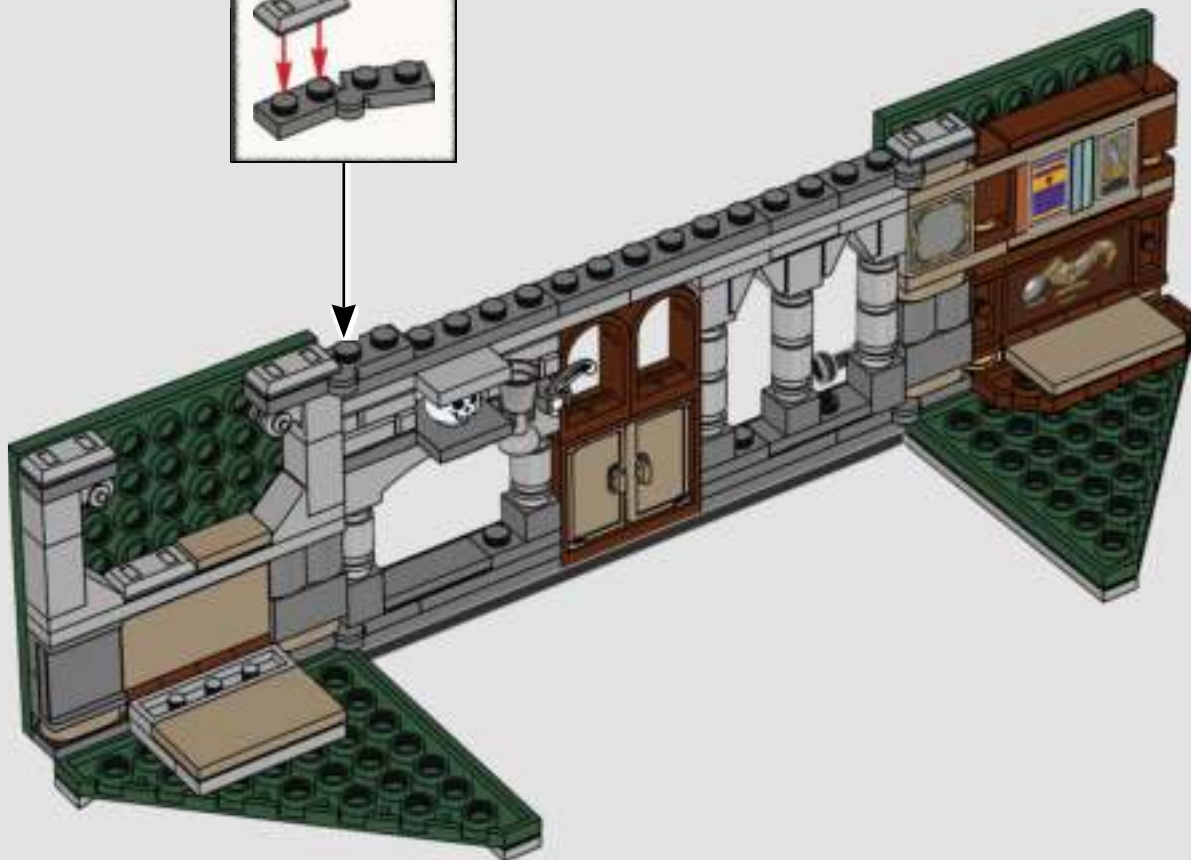
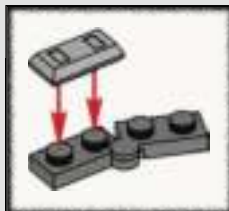

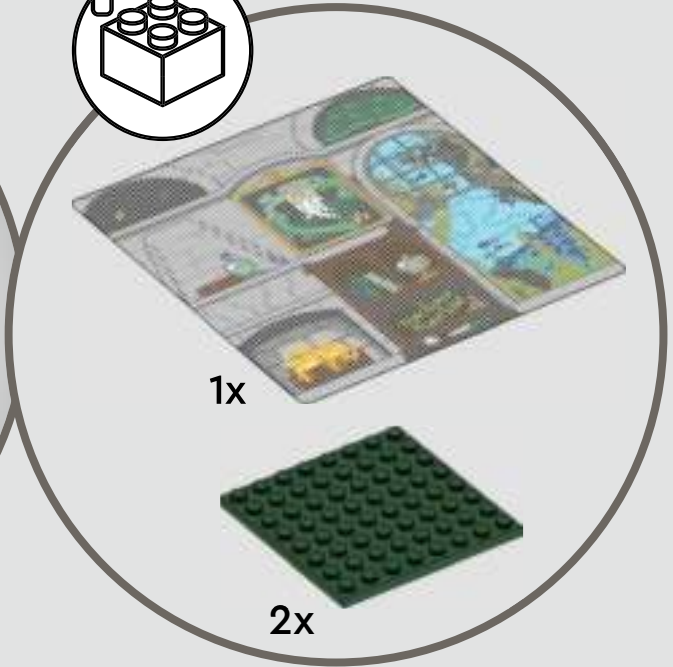
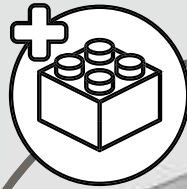

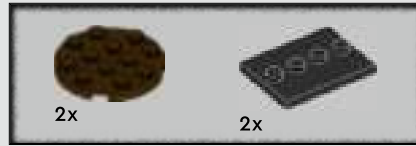

1



2

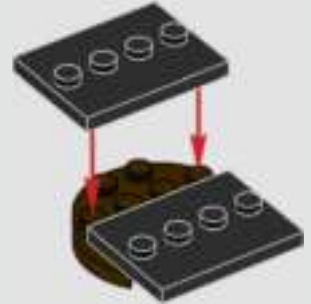

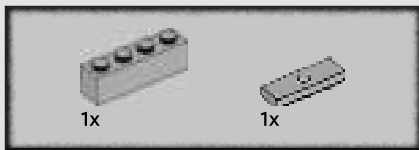

1

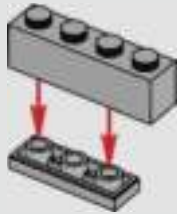

2

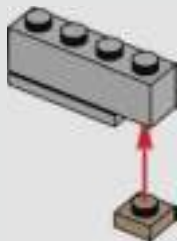

3

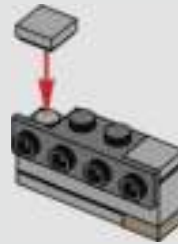

4

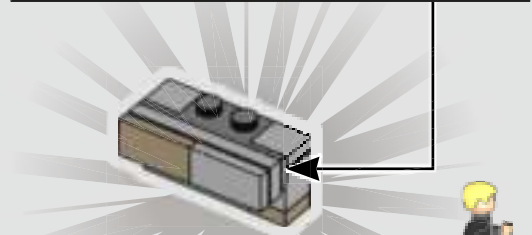



1



2

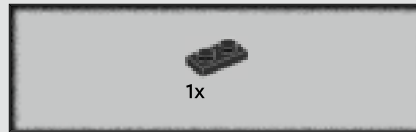

3

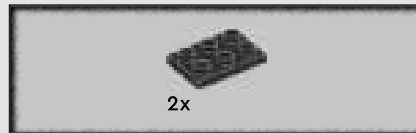

4



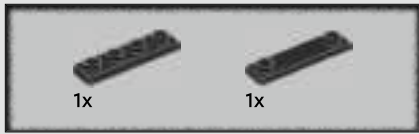

5



6

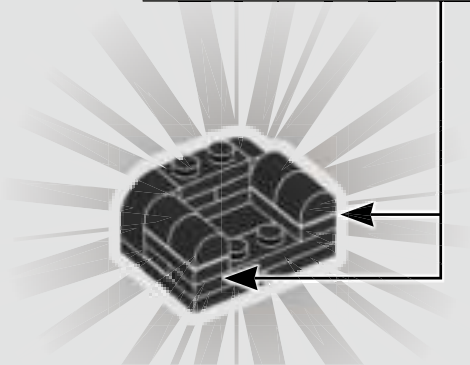
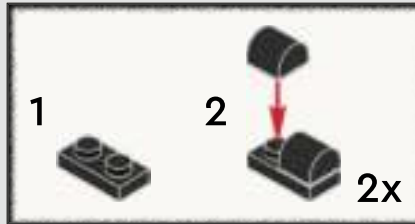





1



2

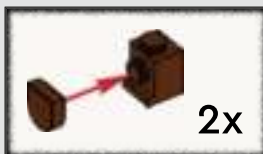

3

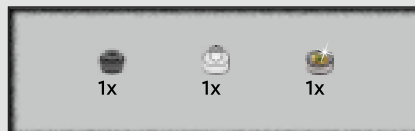

4



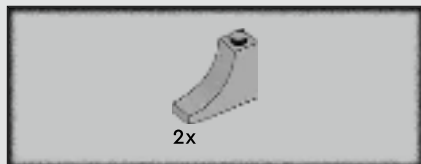

57



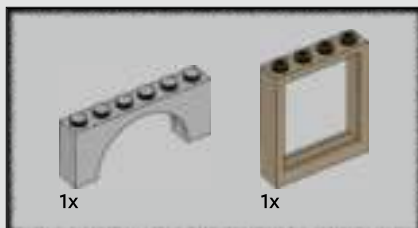

58

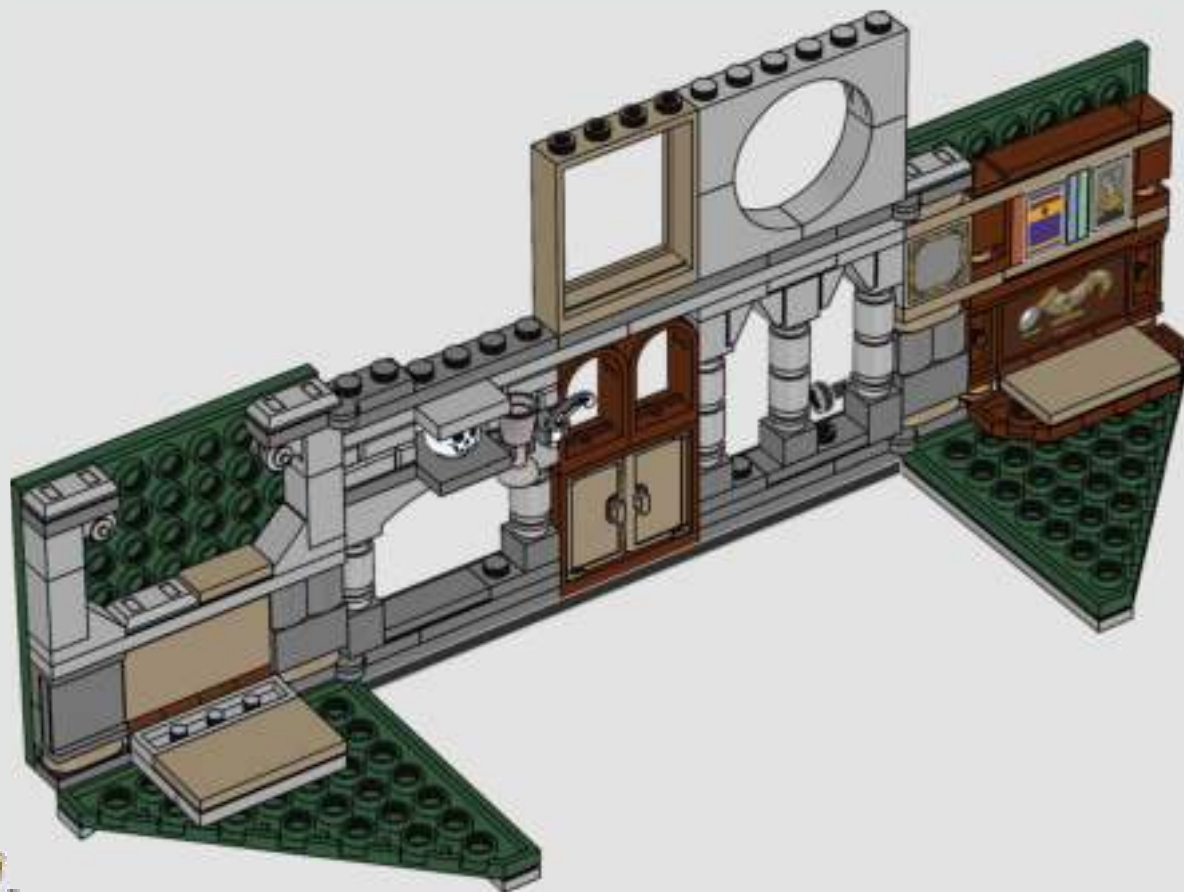

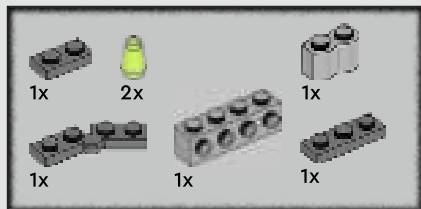

59

1



2

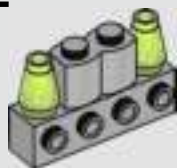

3

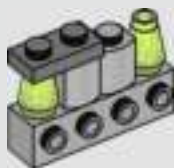

4

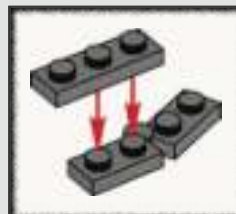
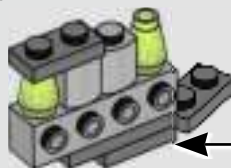

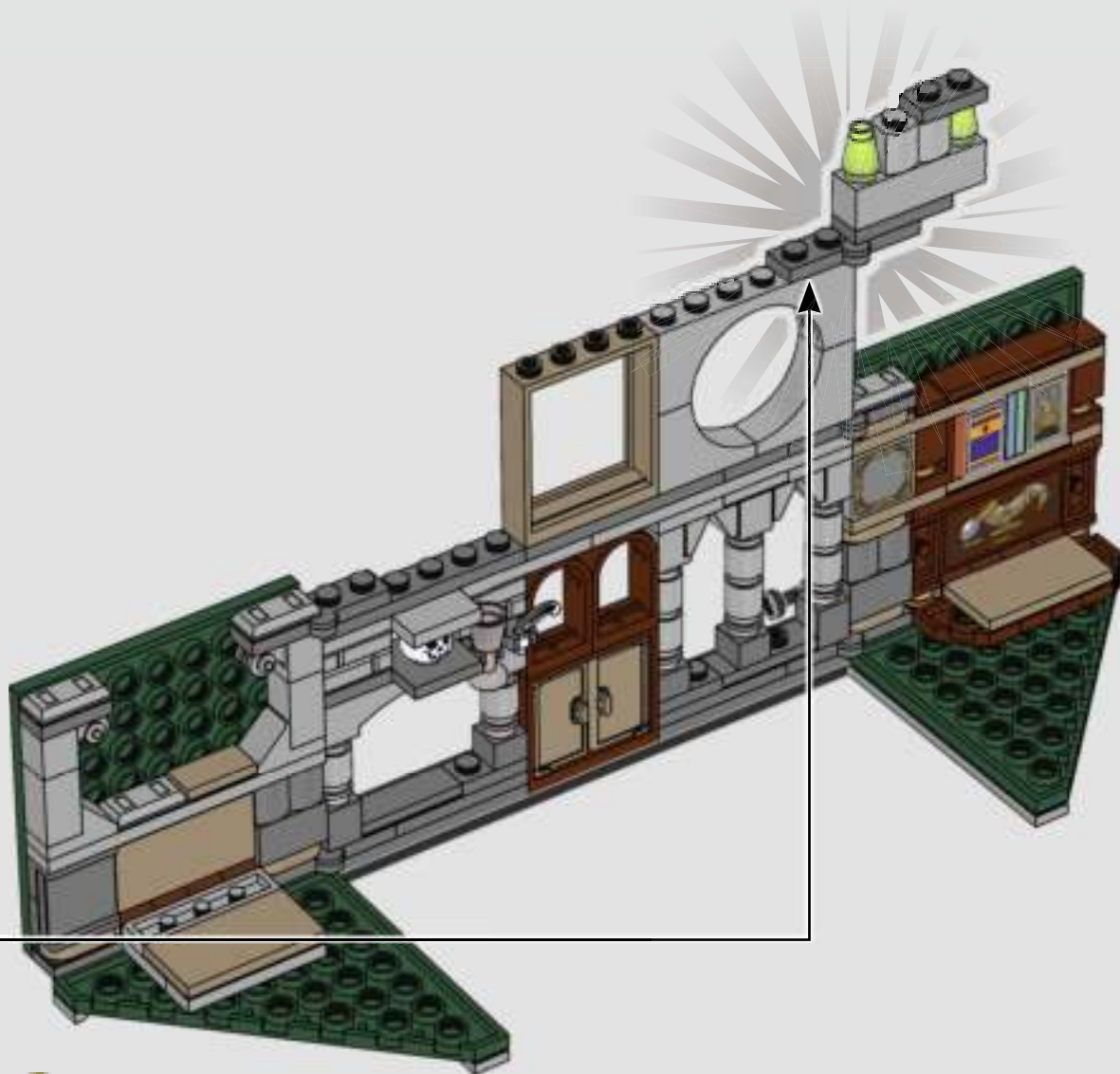

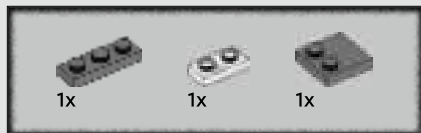

60

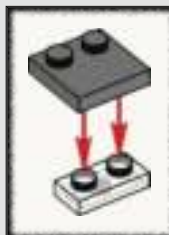



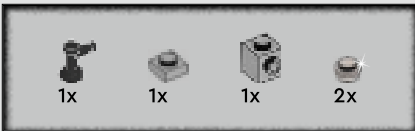

61

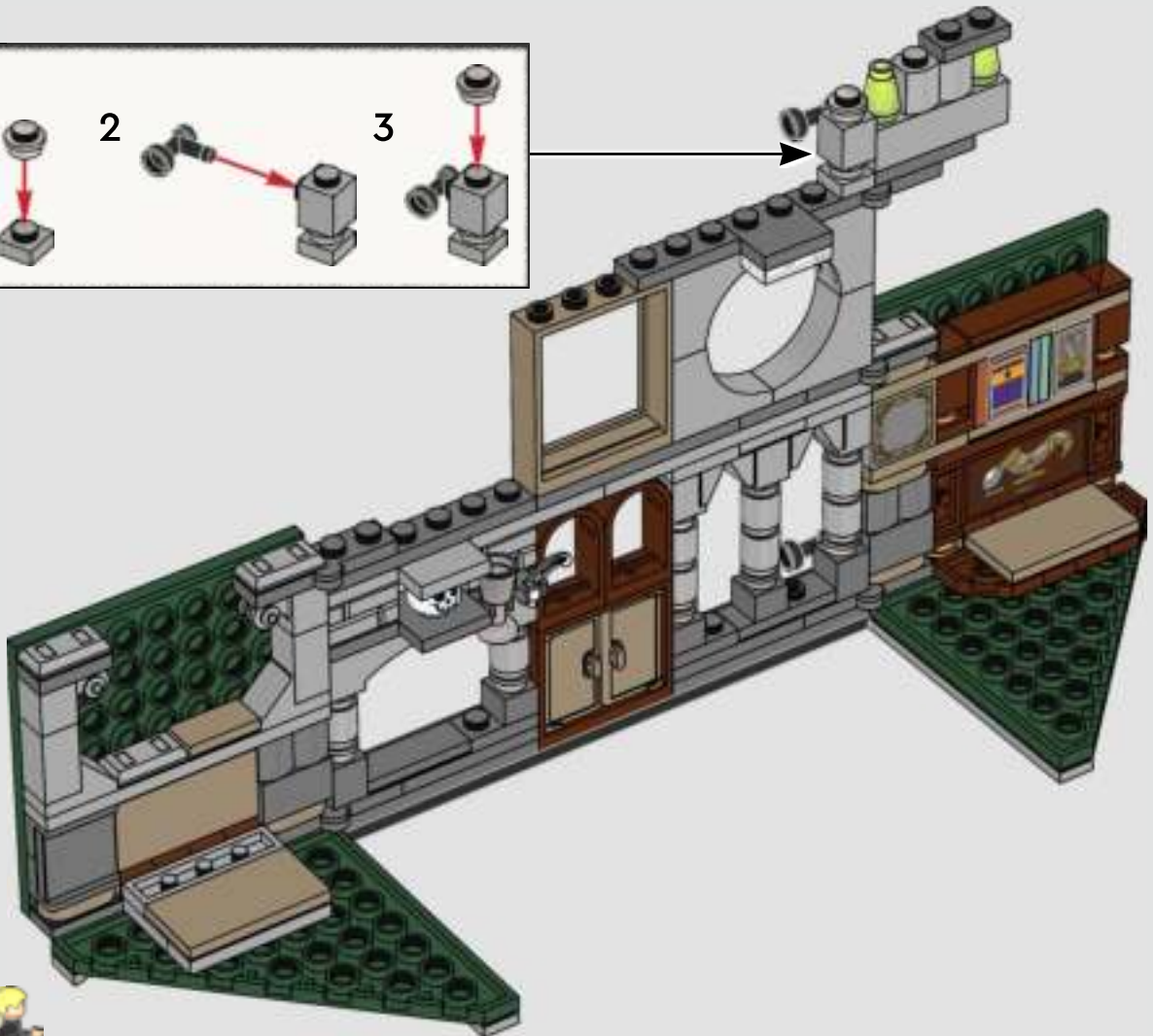
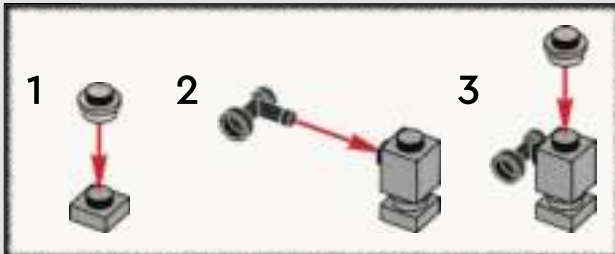



62







63

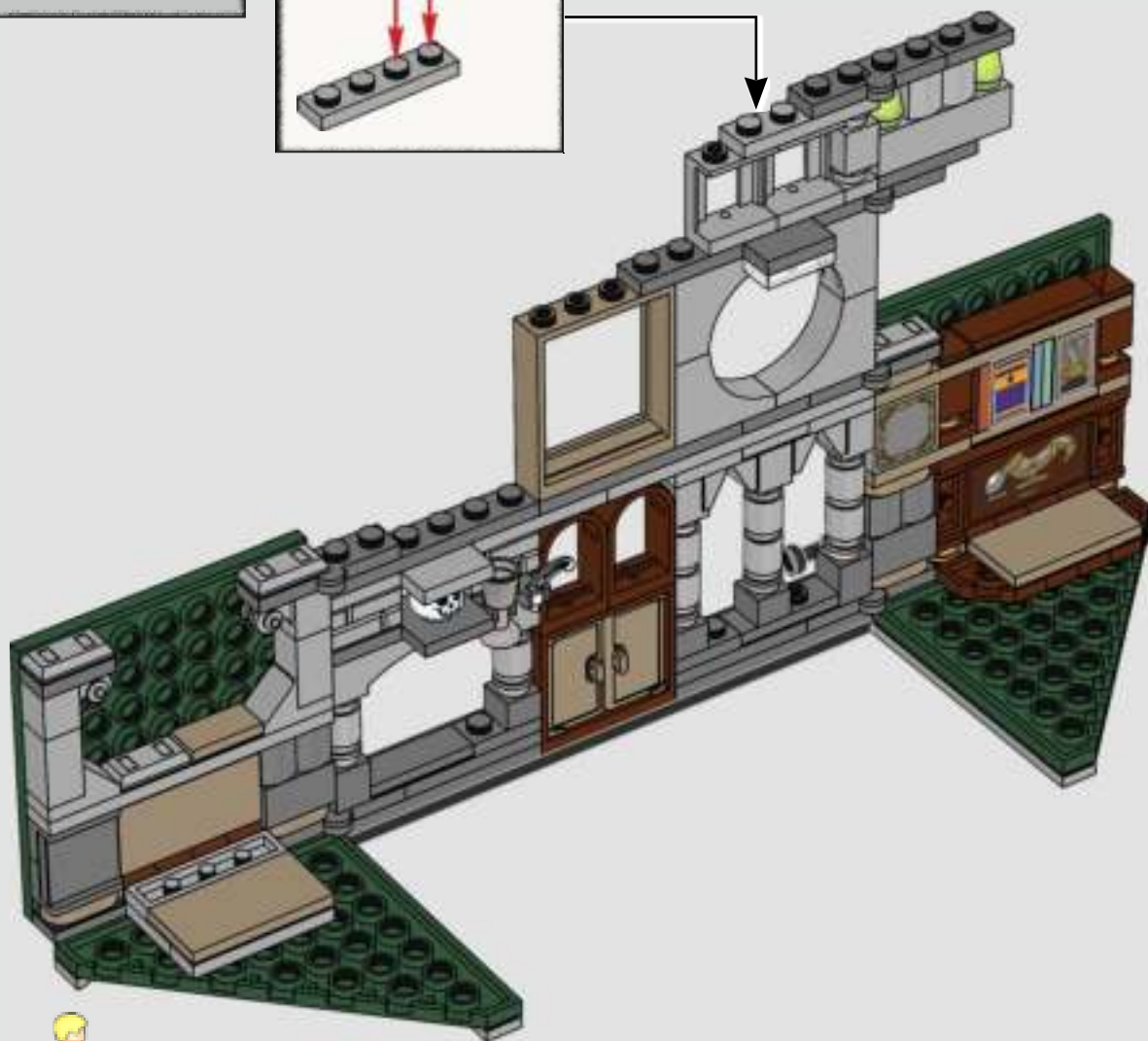
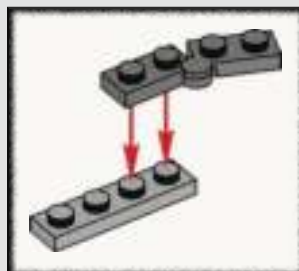

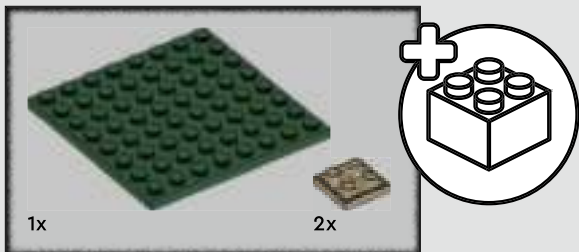

64

1

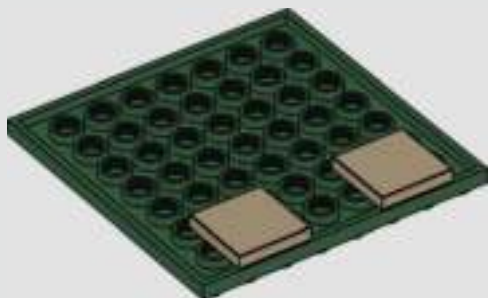

2

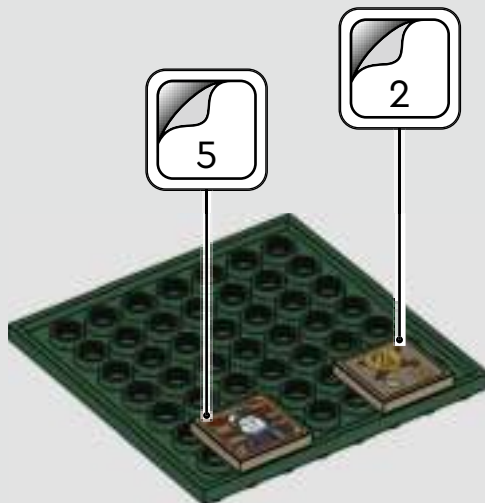

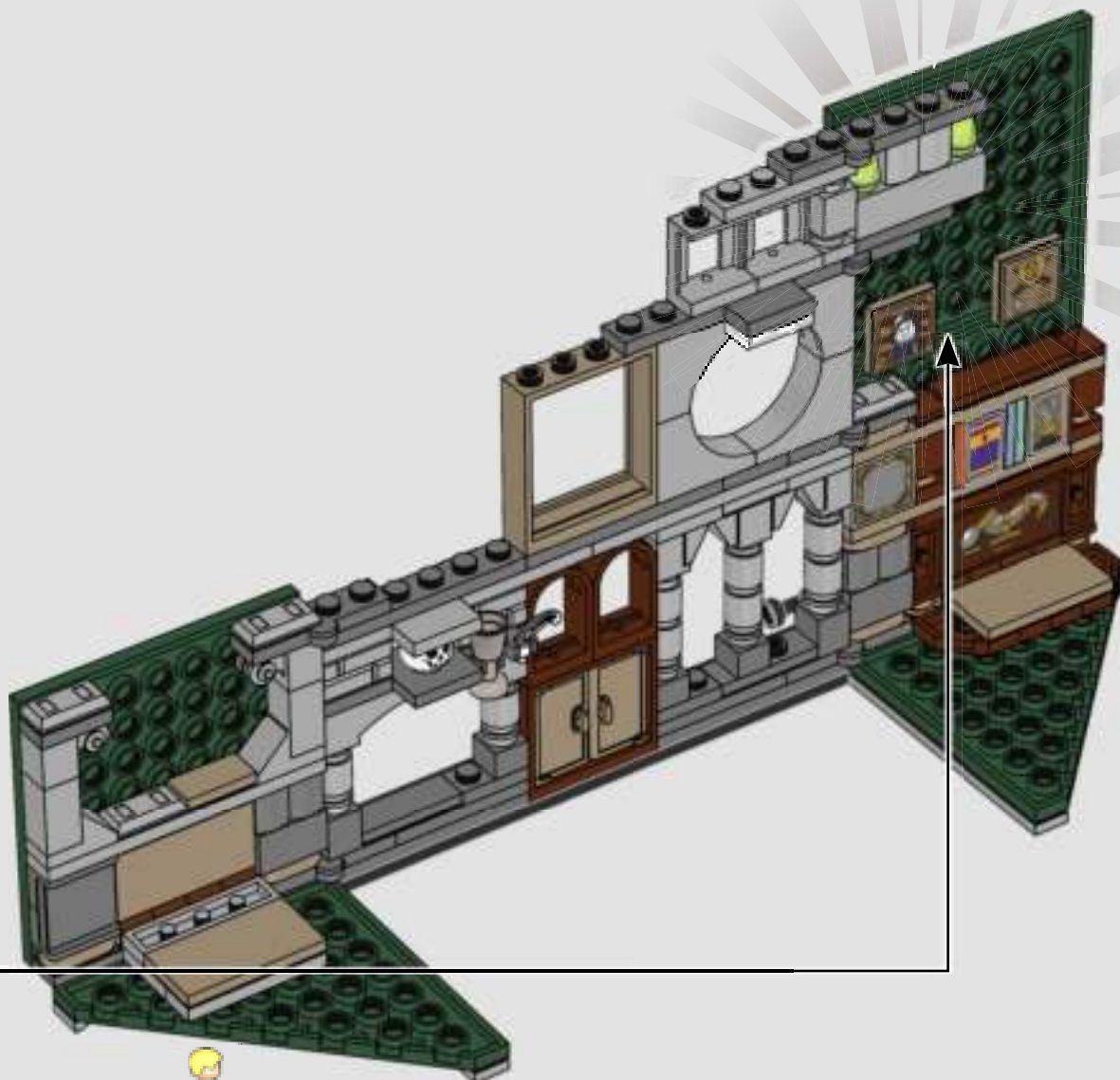



65

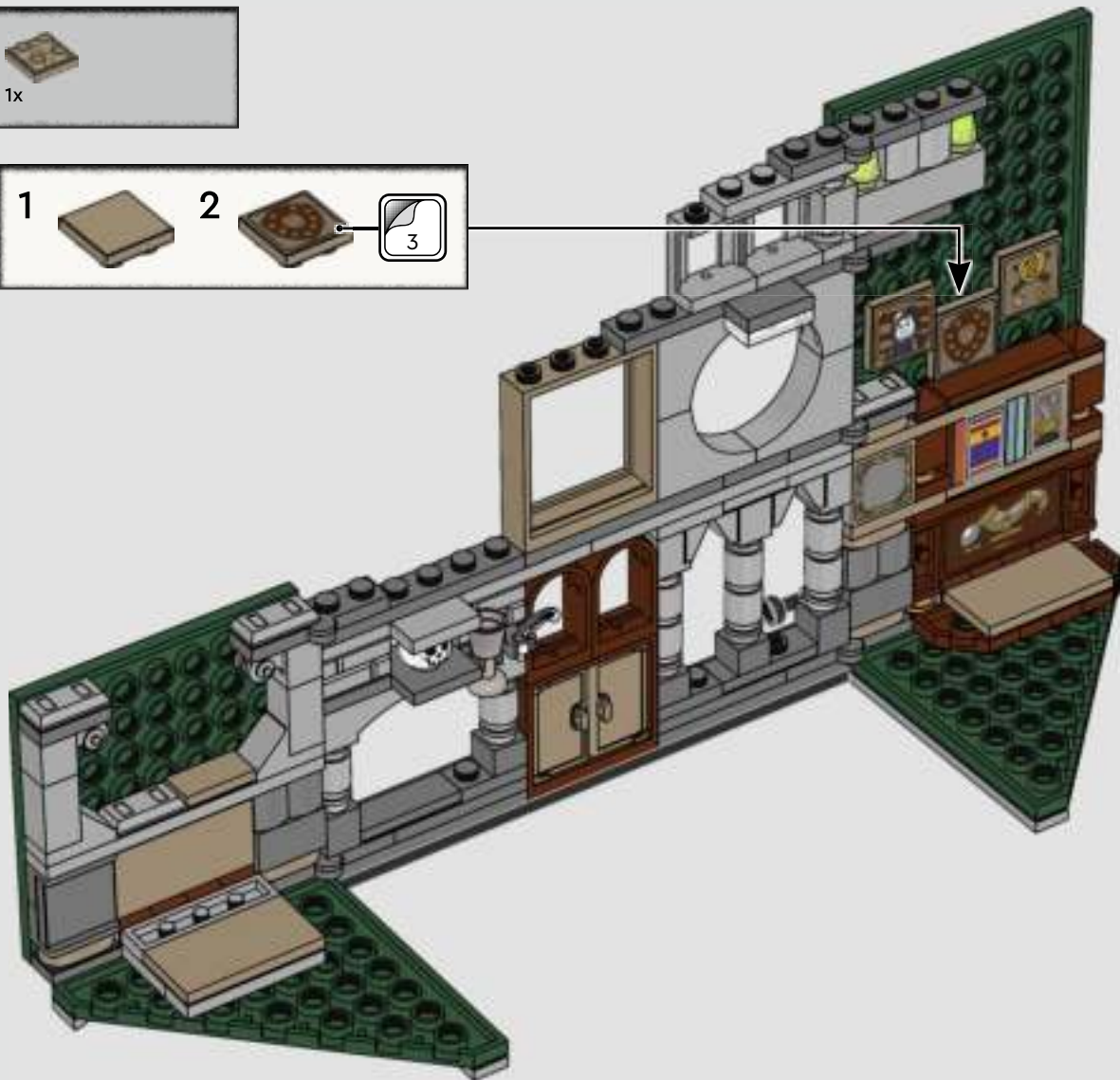

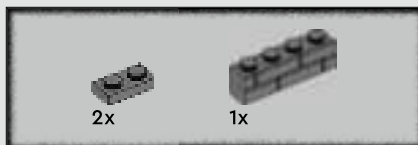

66

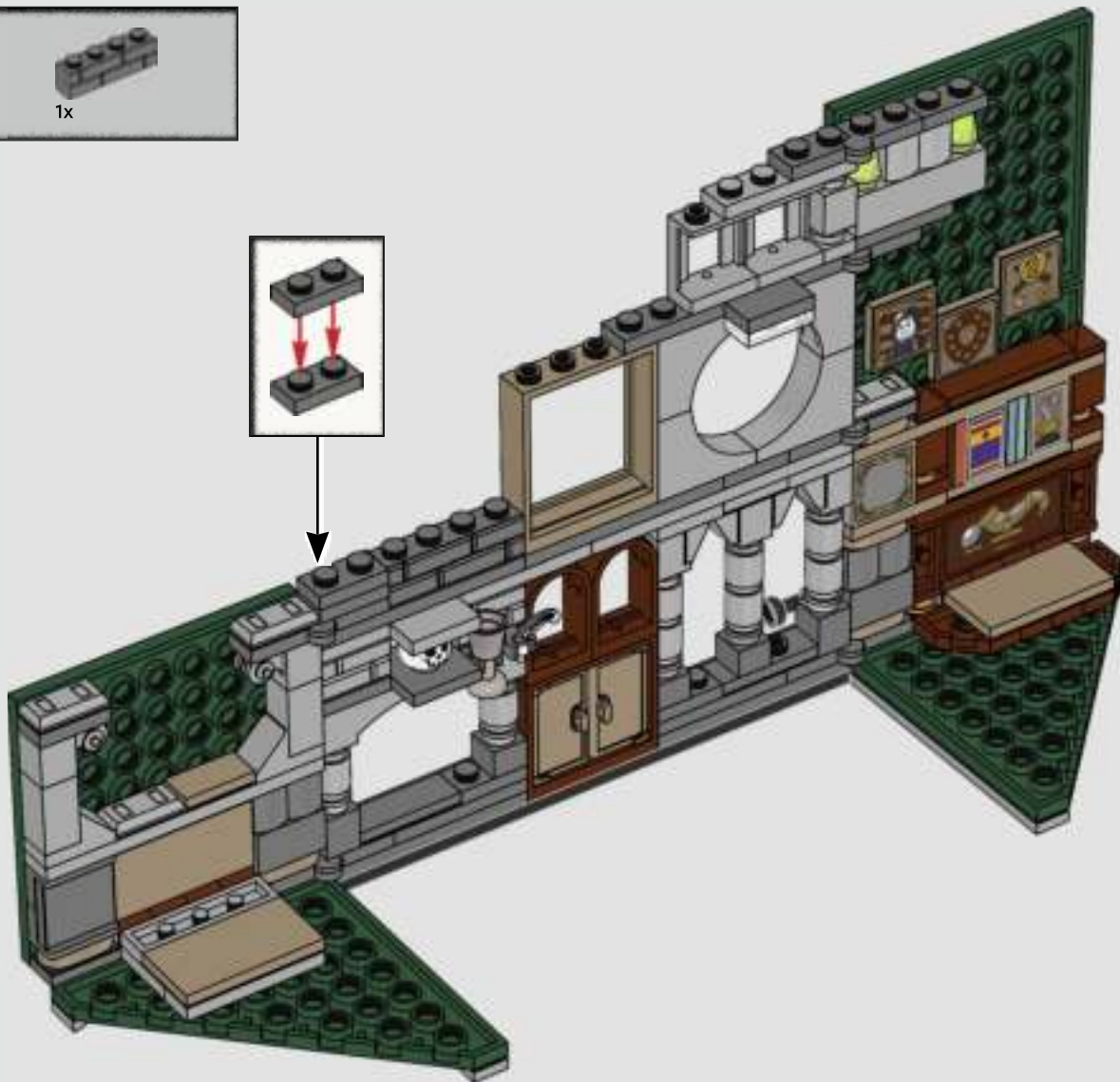
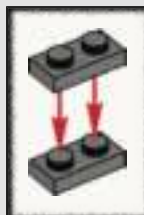



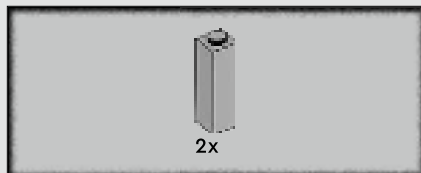

67

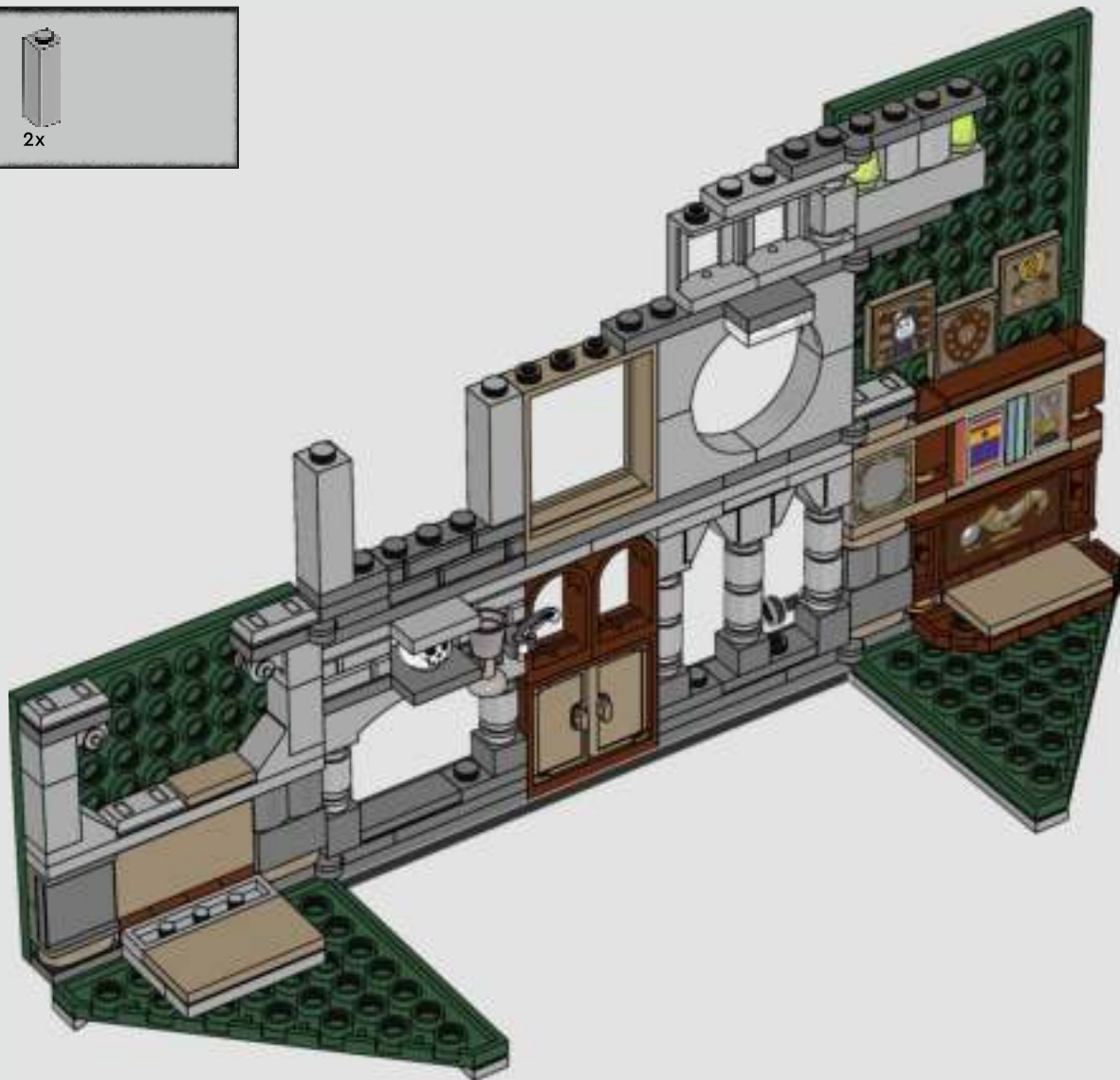

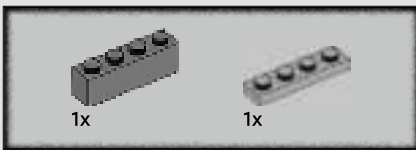

68

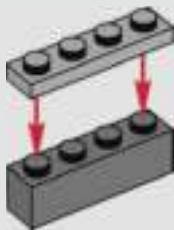

69

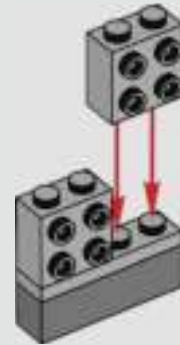

70

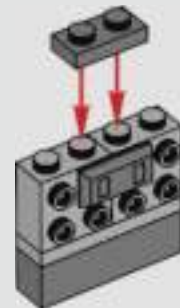

71

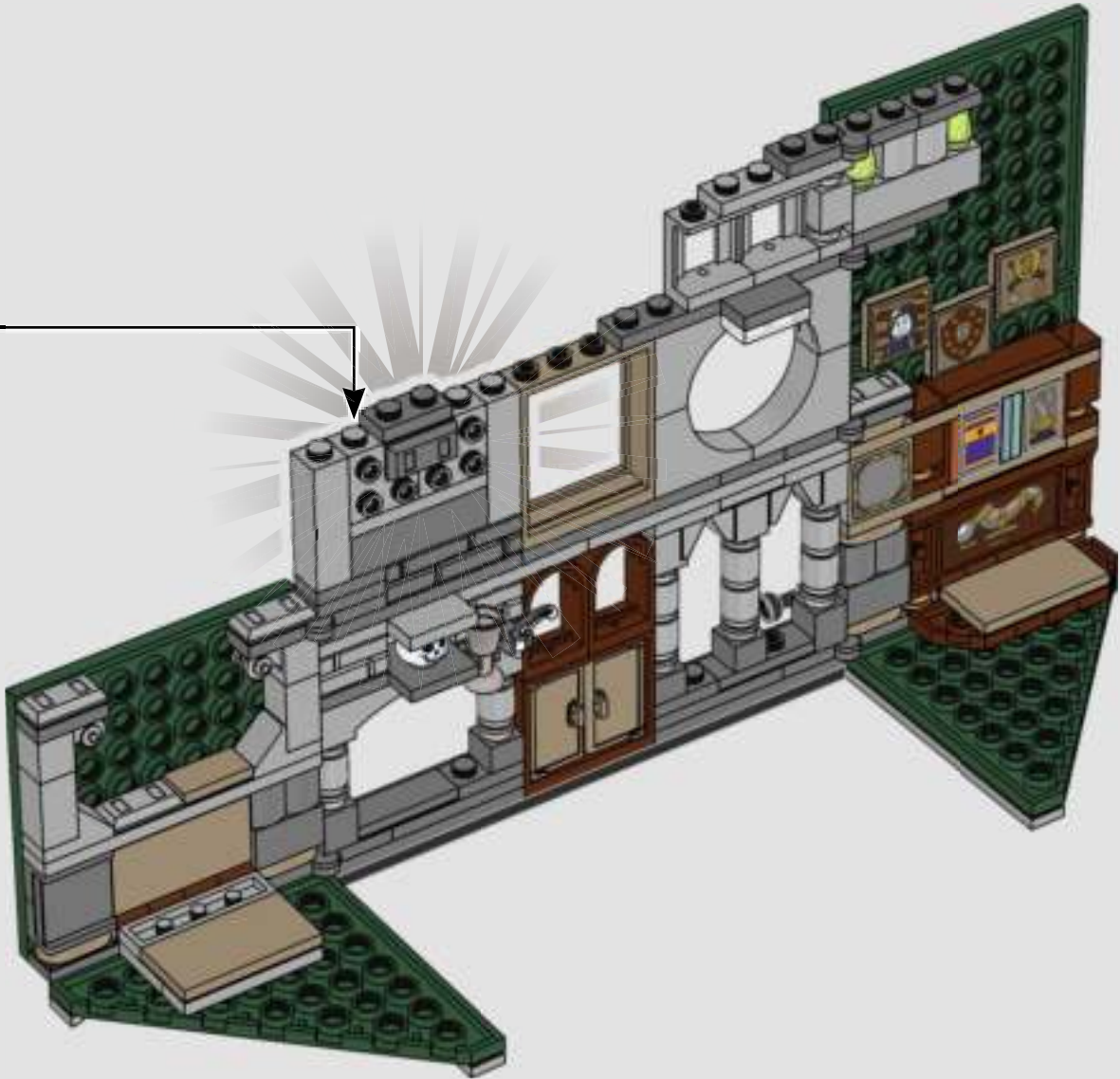





72

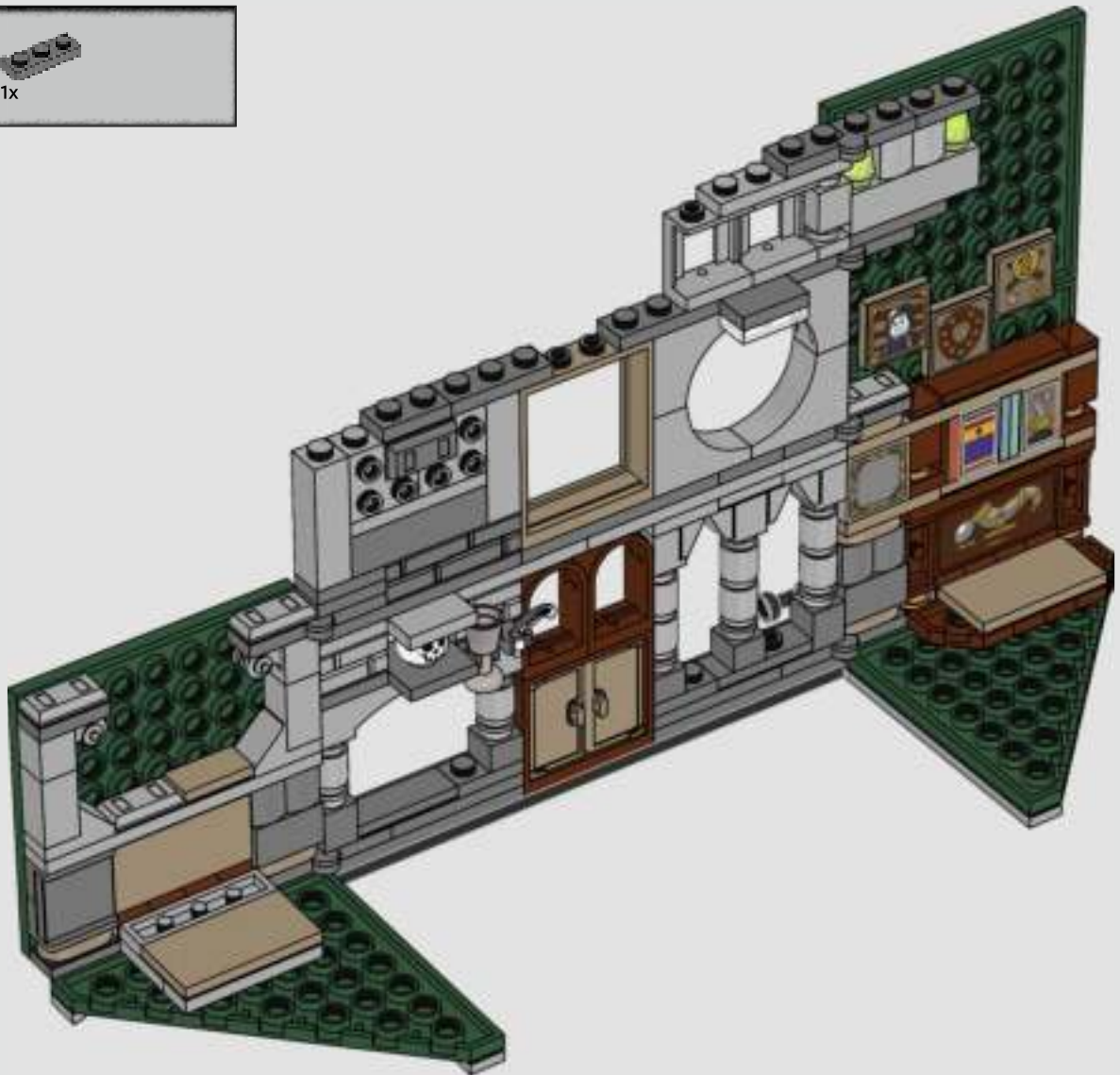

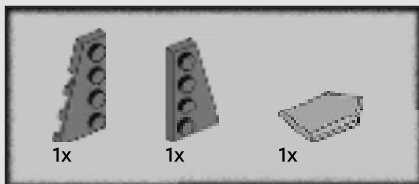

73

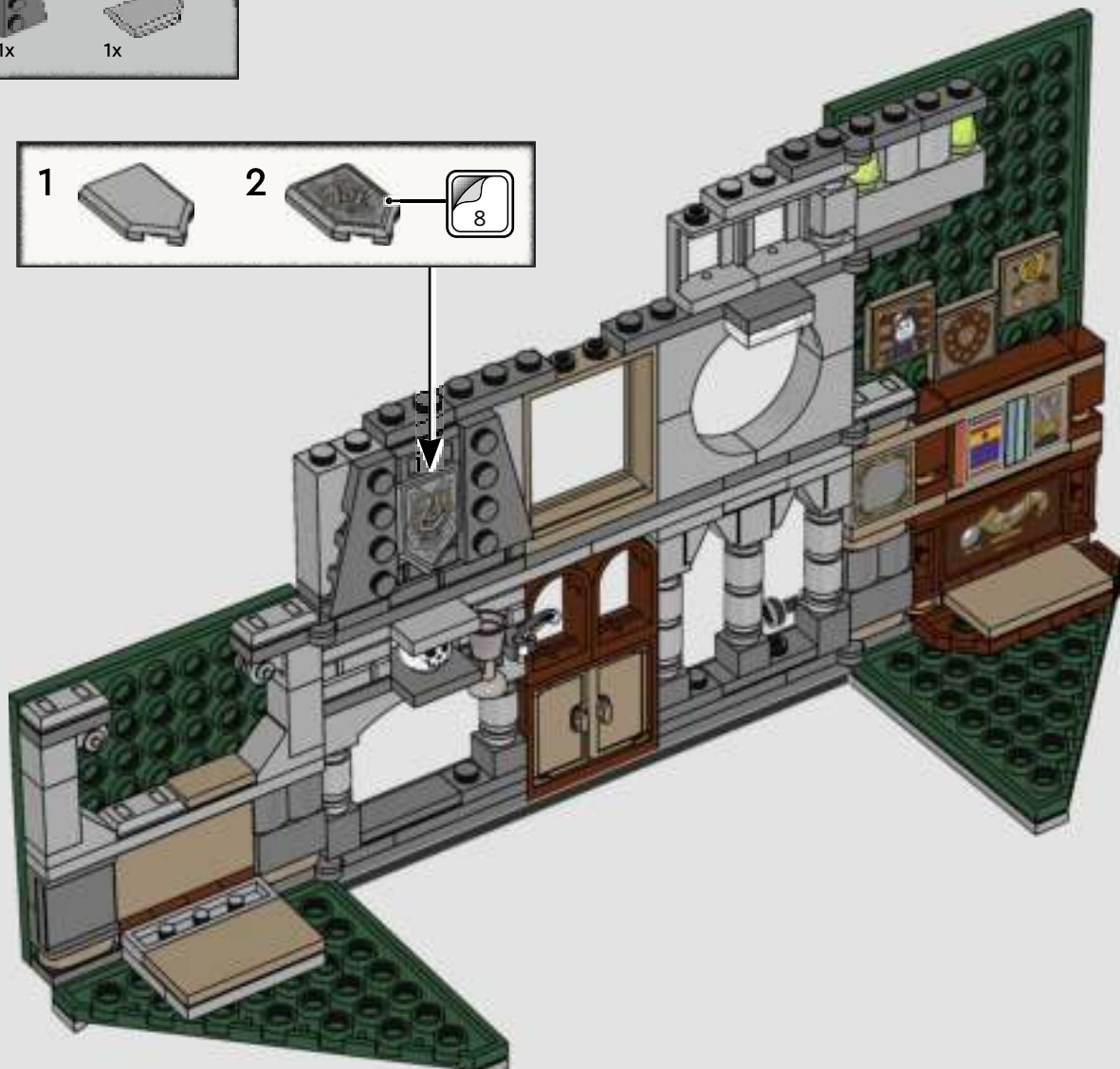

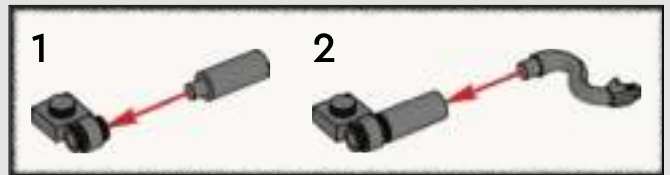

74

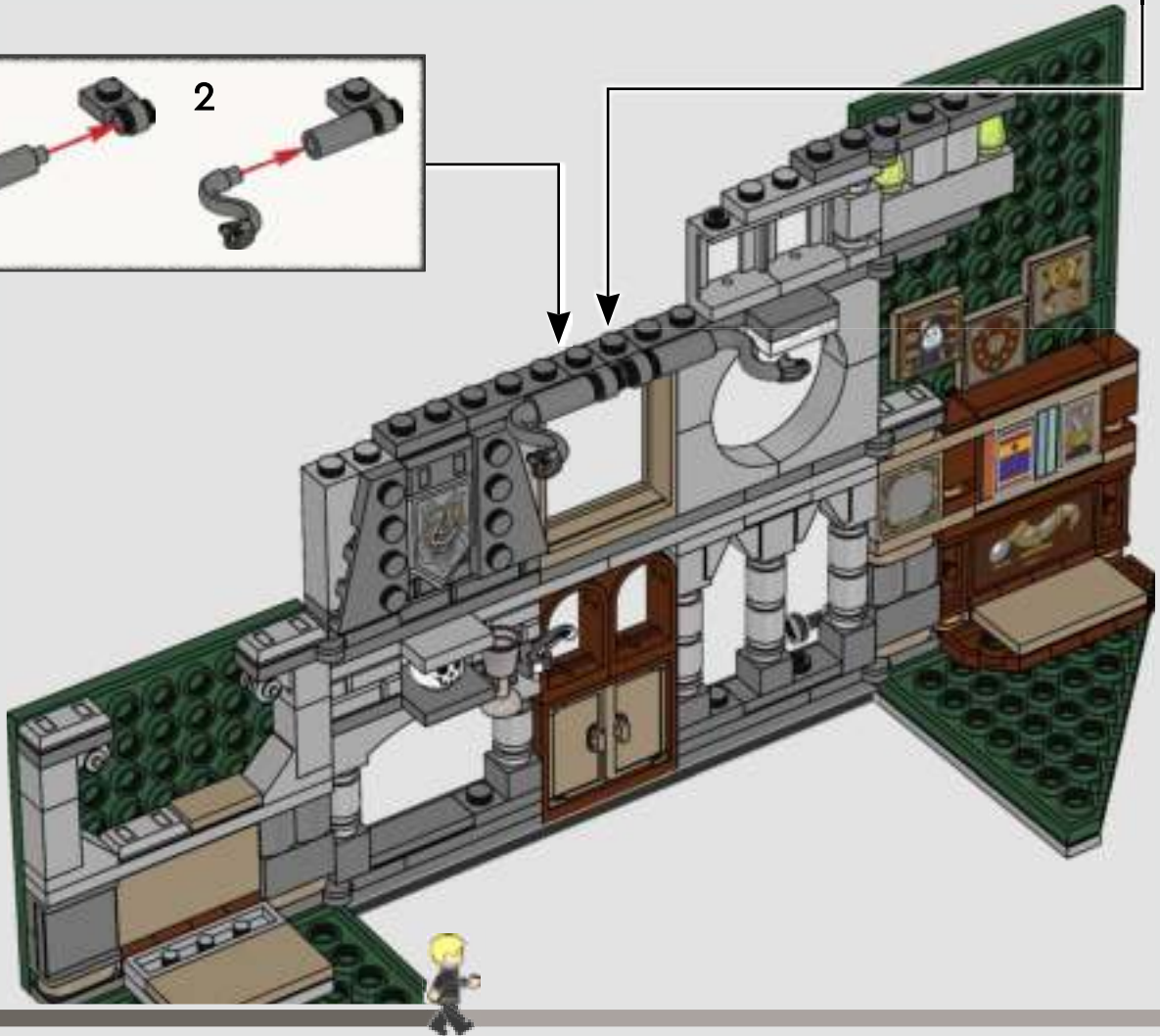
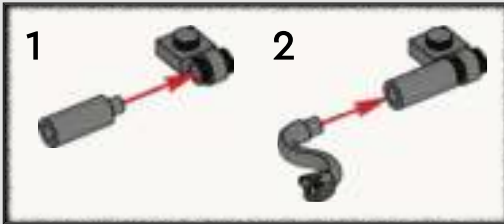

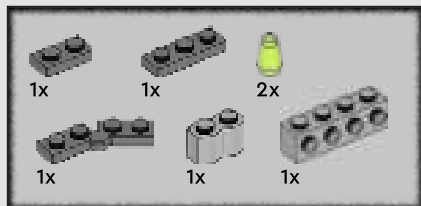

75

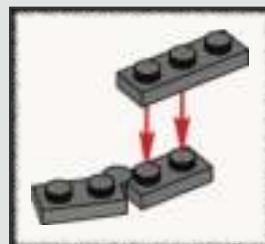

1



2

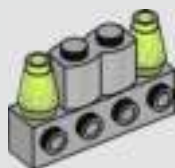

3

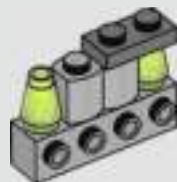

4

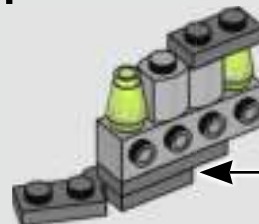

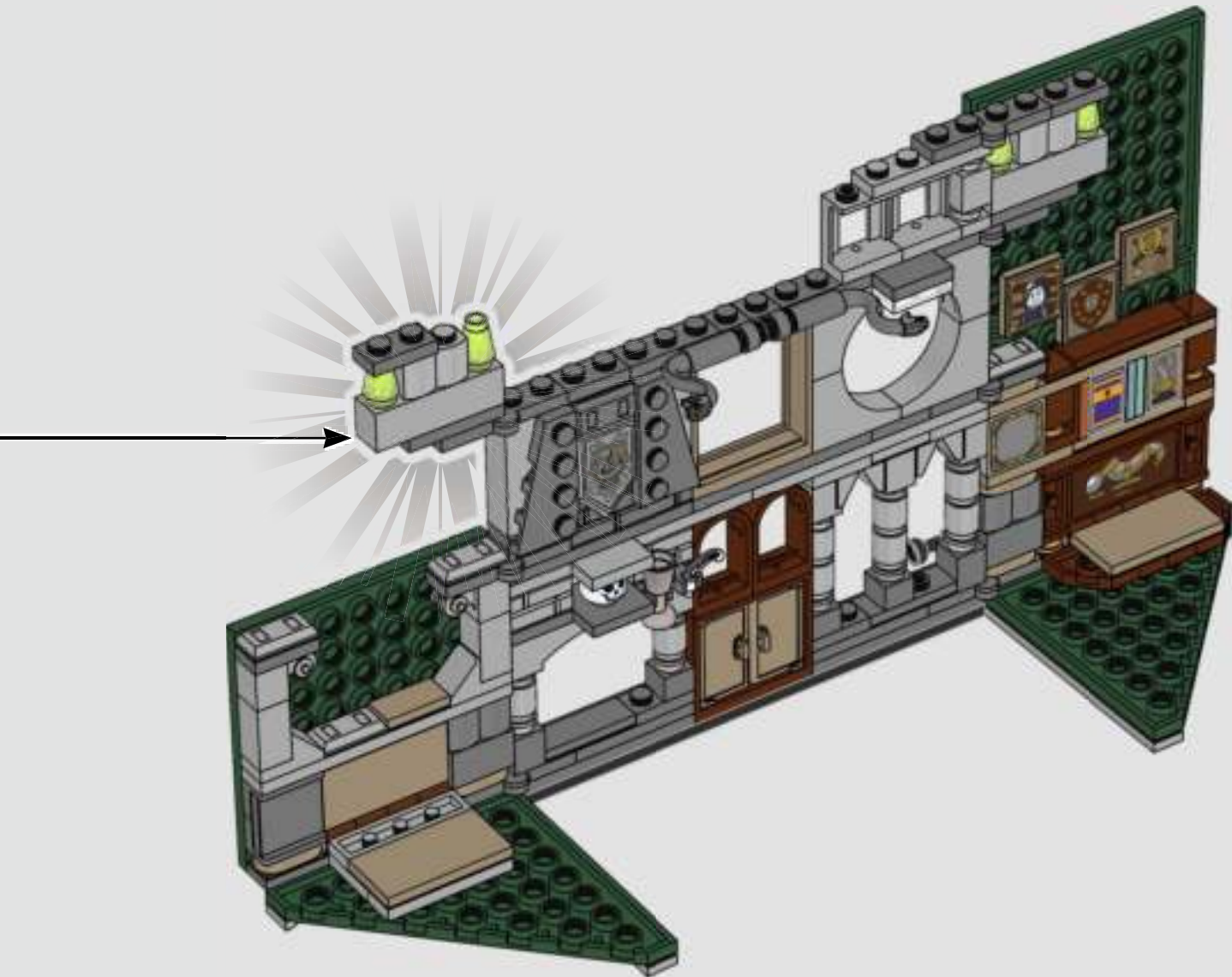



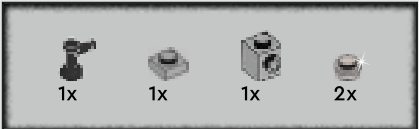

76

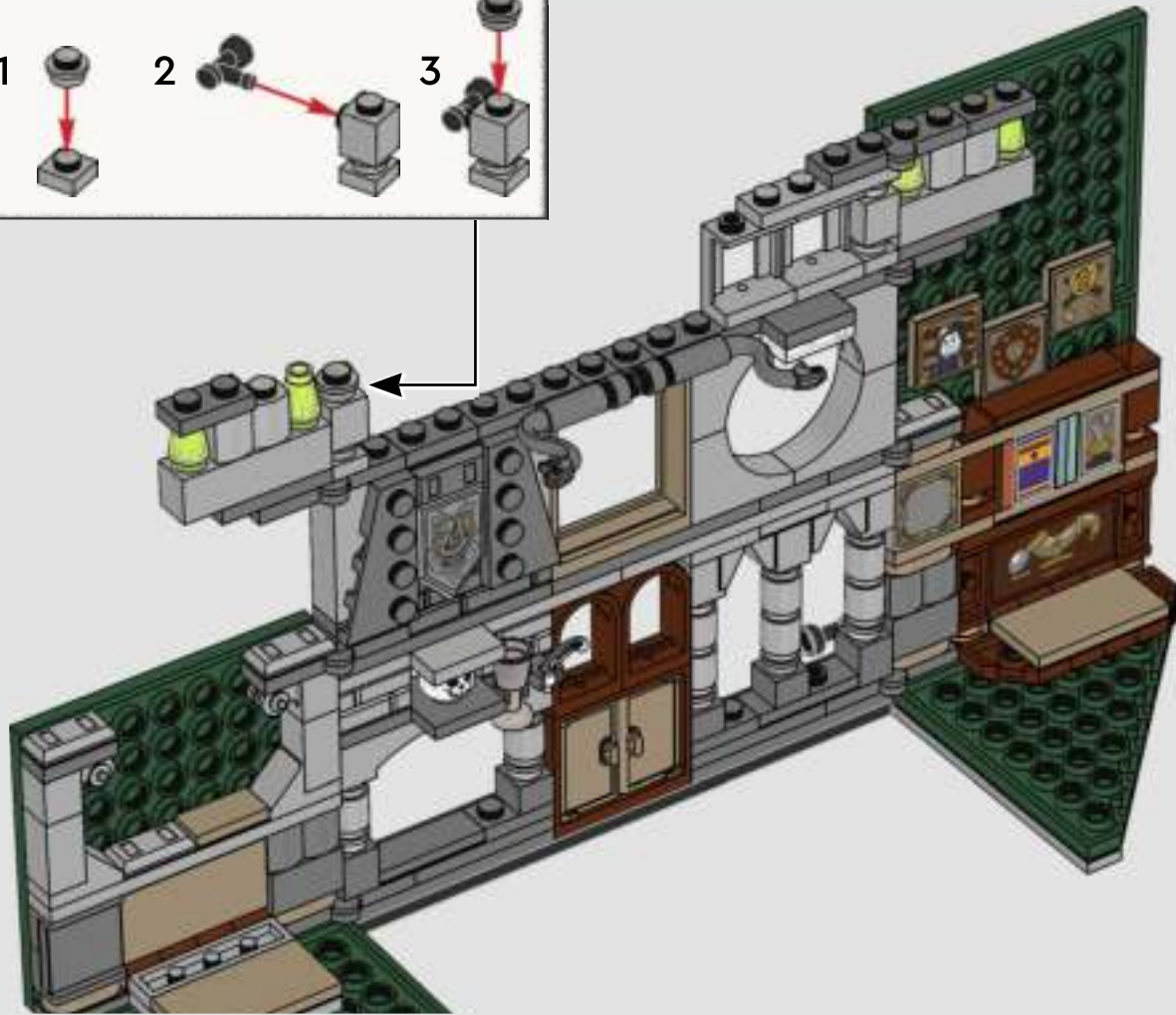
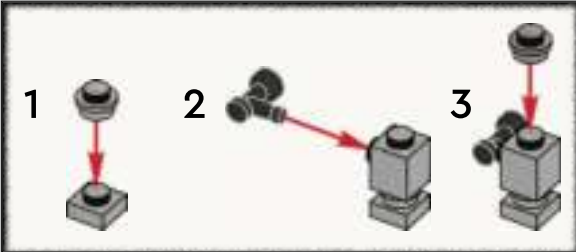

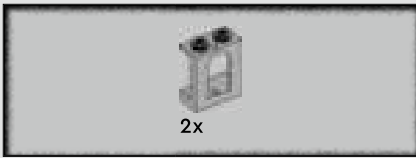

77

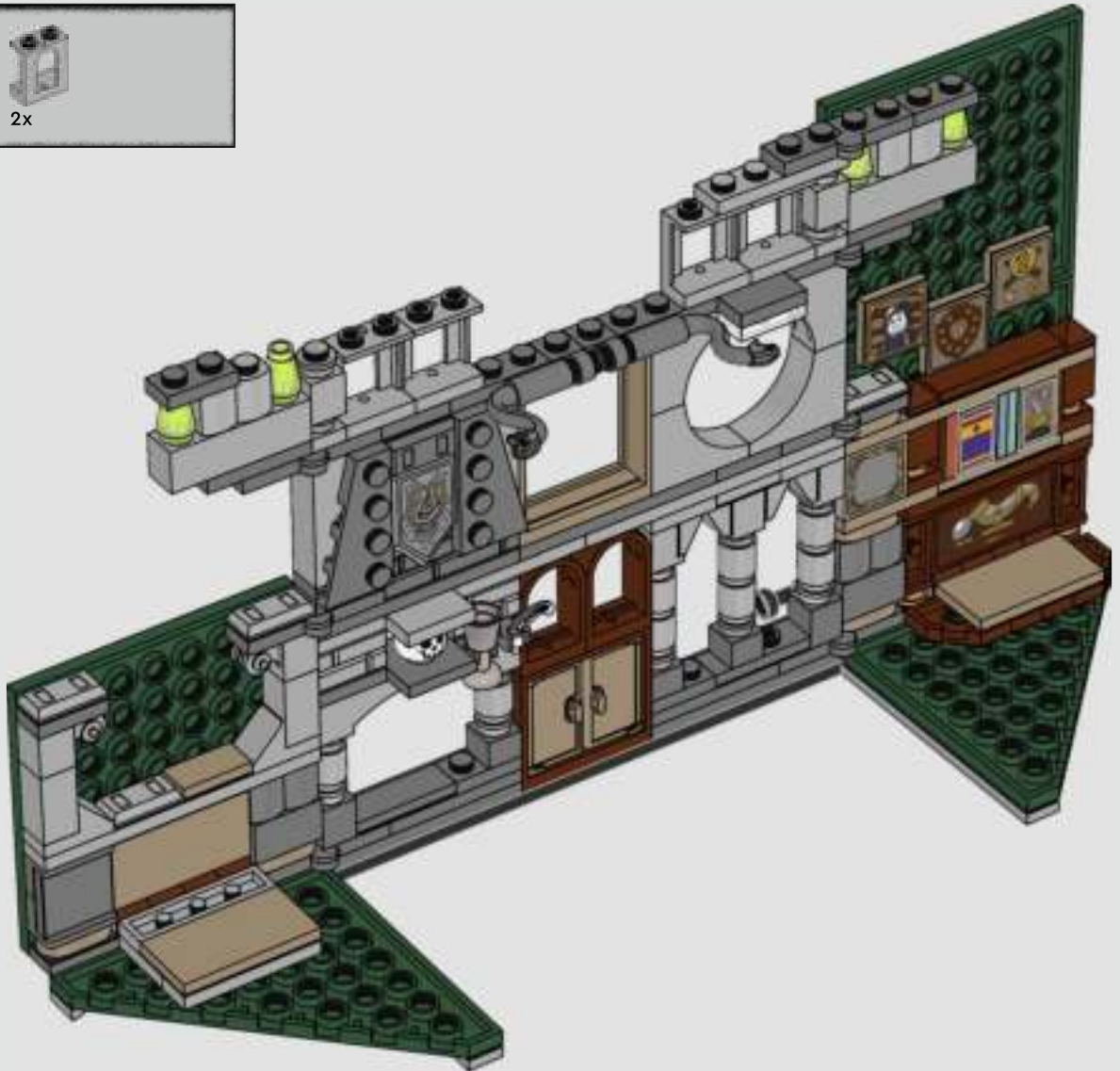

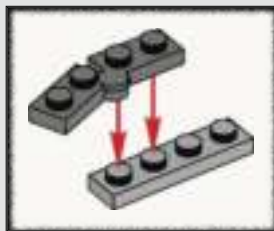

78

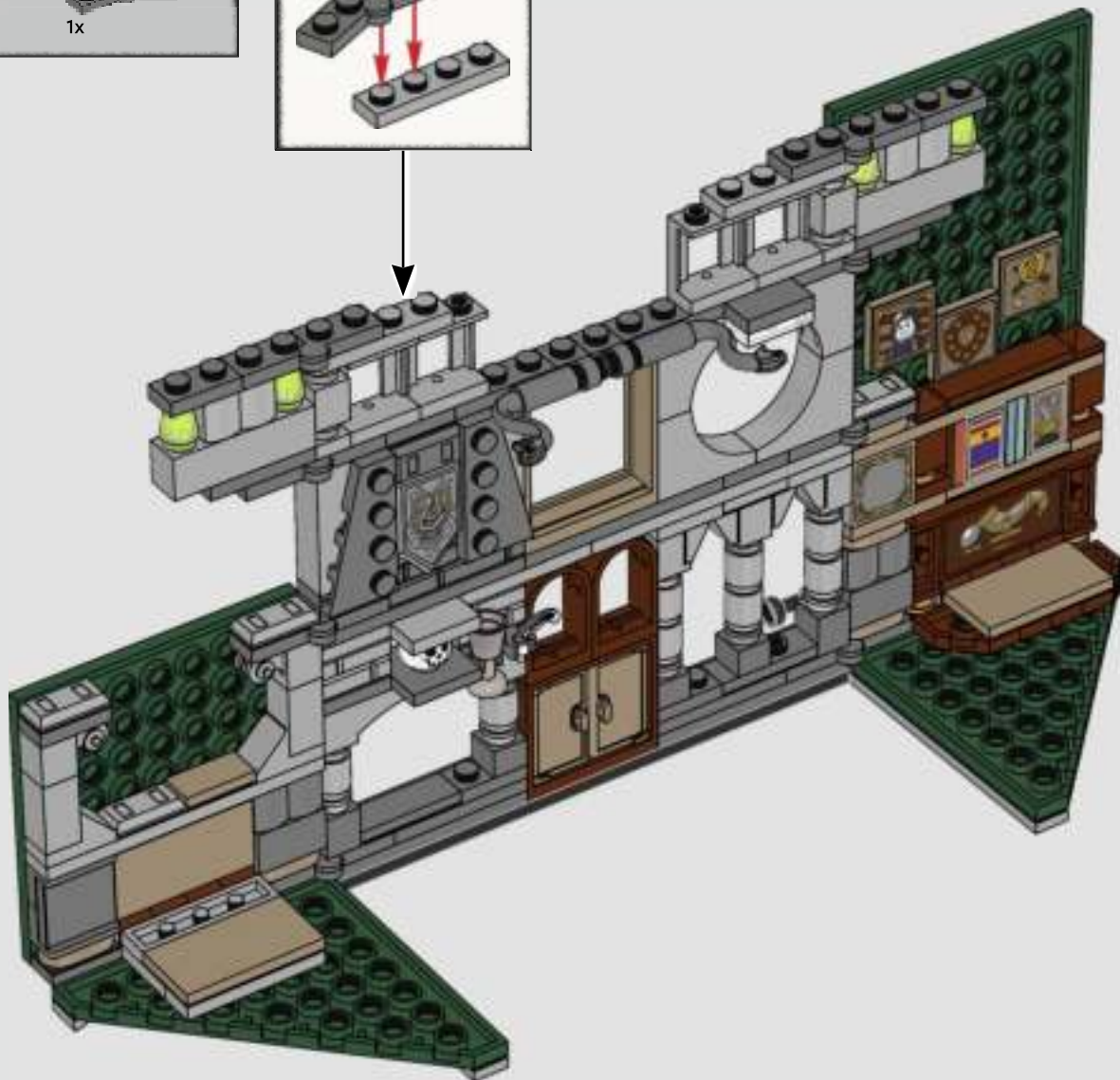



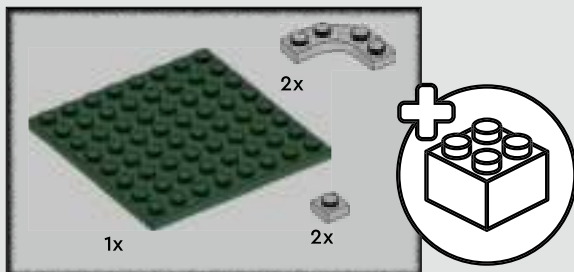

79

1



2

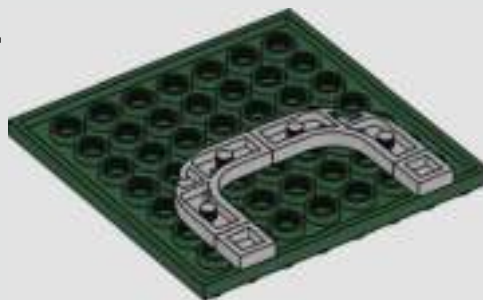

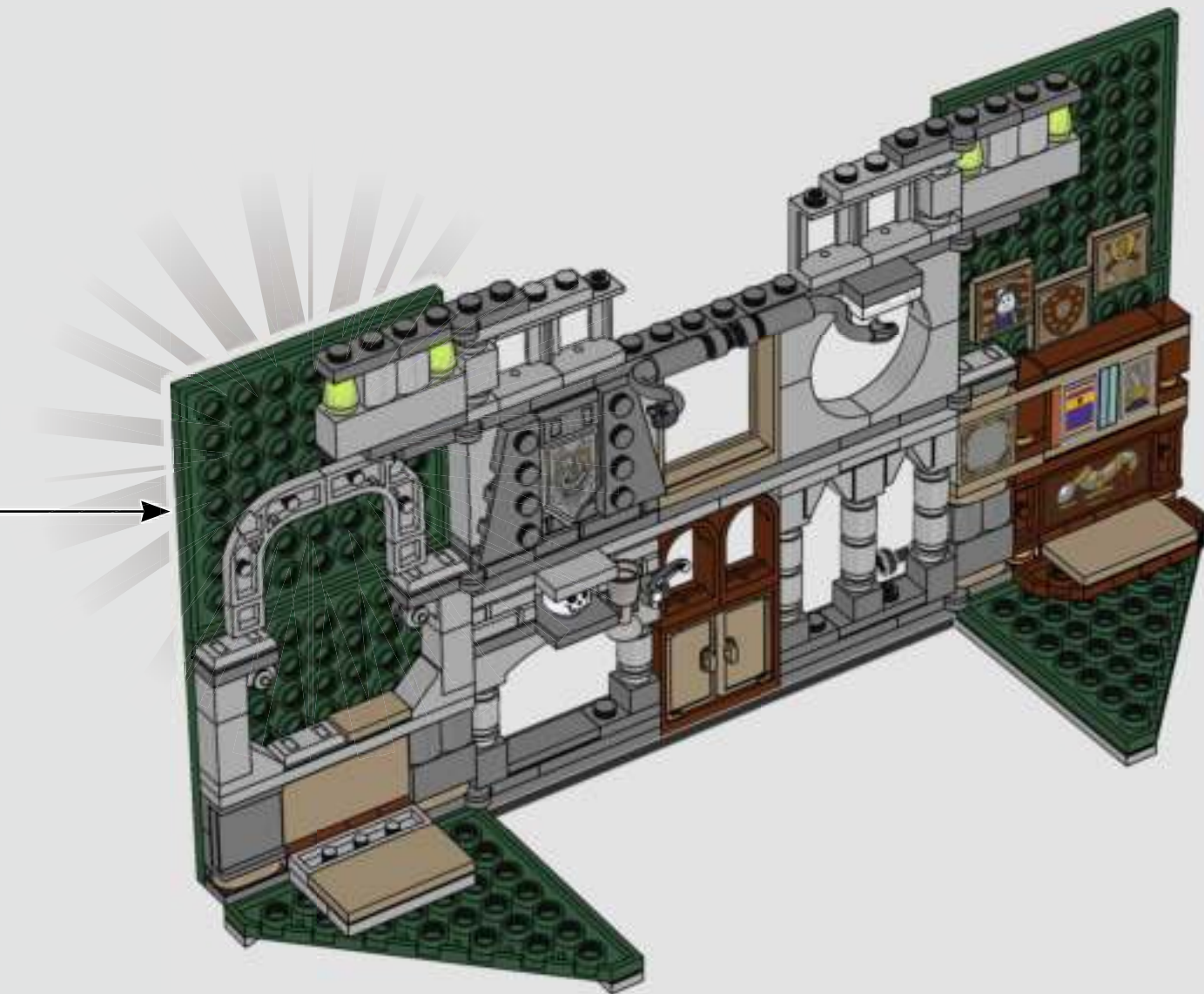



80

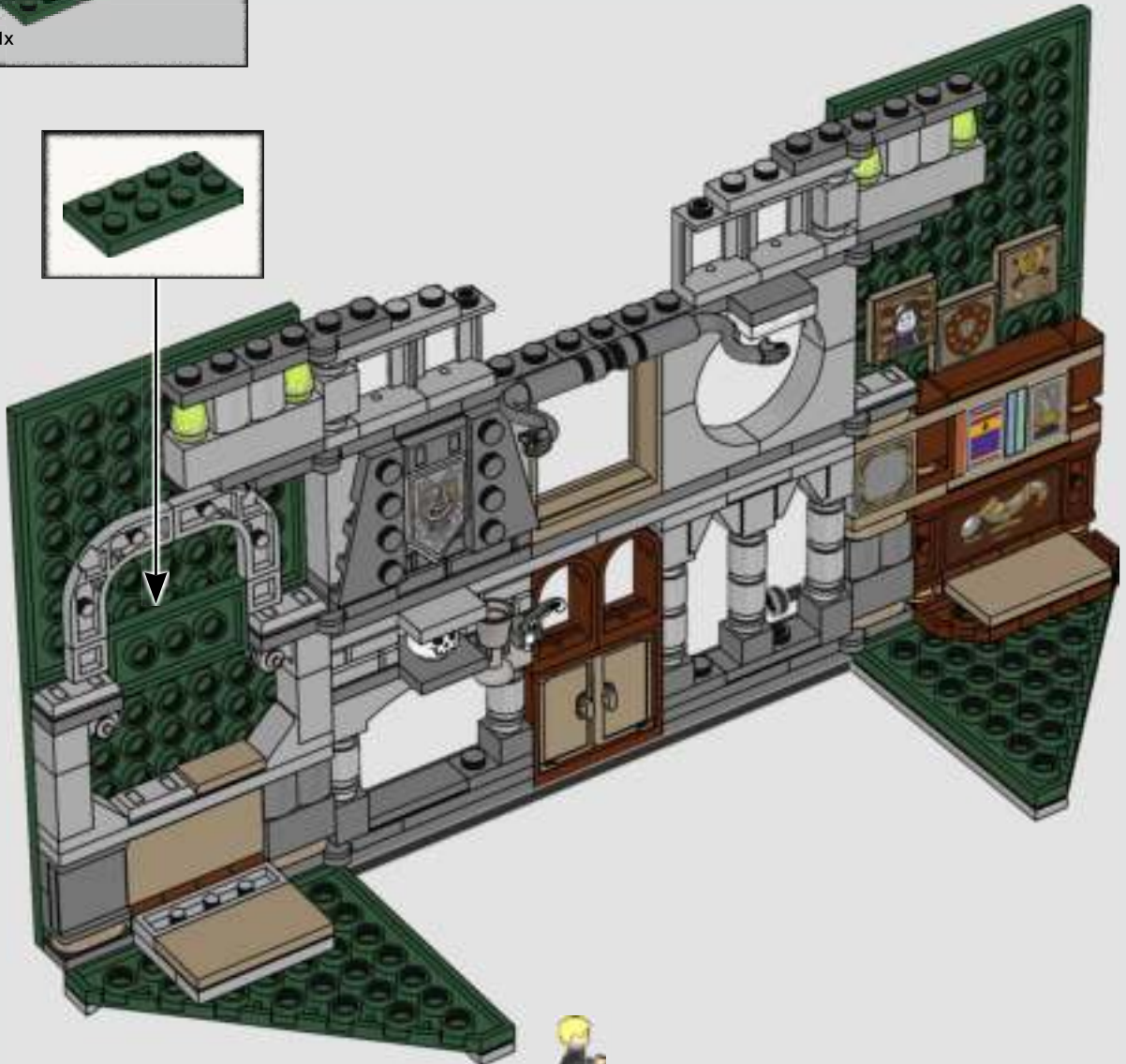

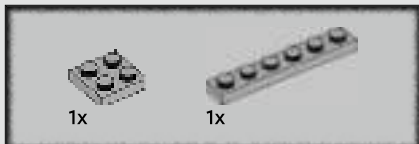

81

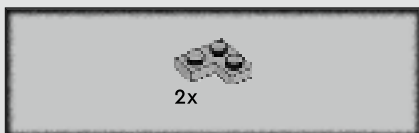
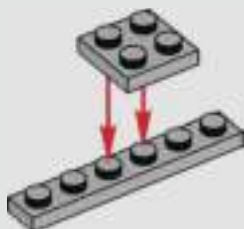

82

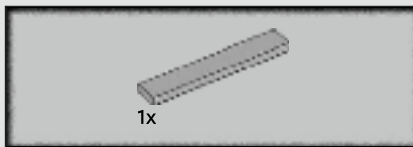
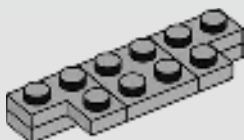

83

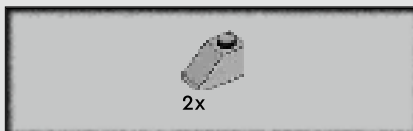
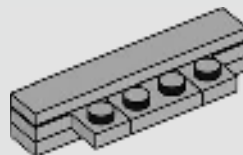

84

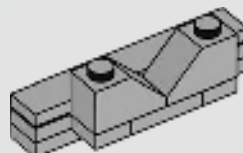

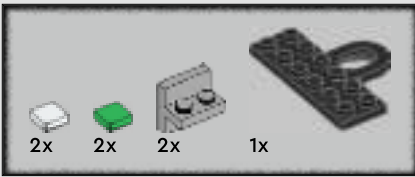

85

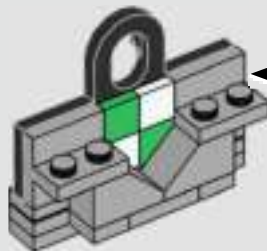
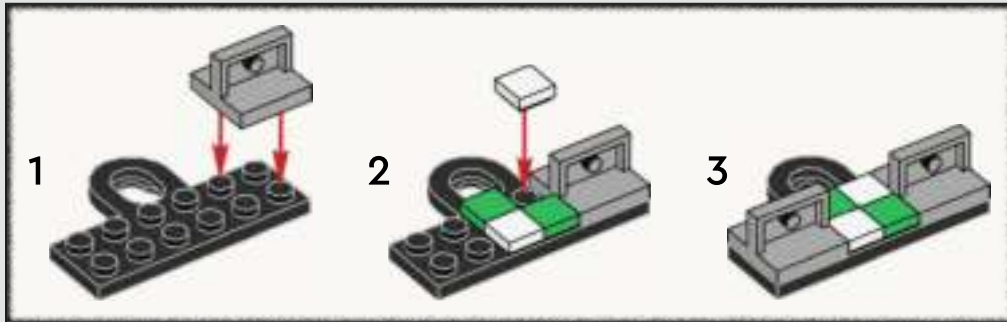

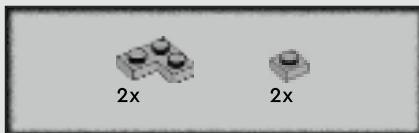

86

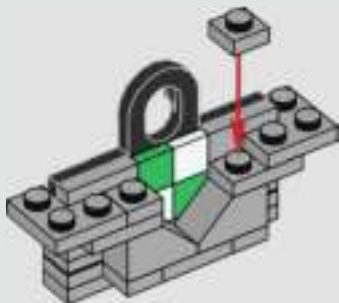

87

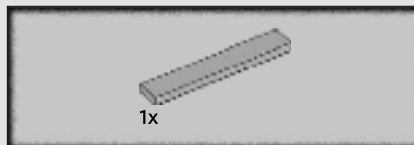
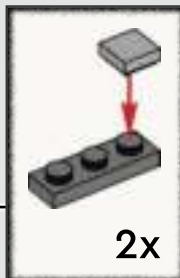
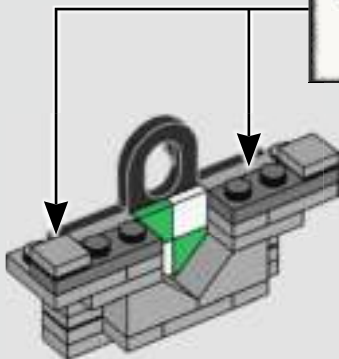

88

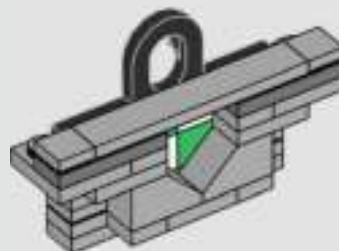



89

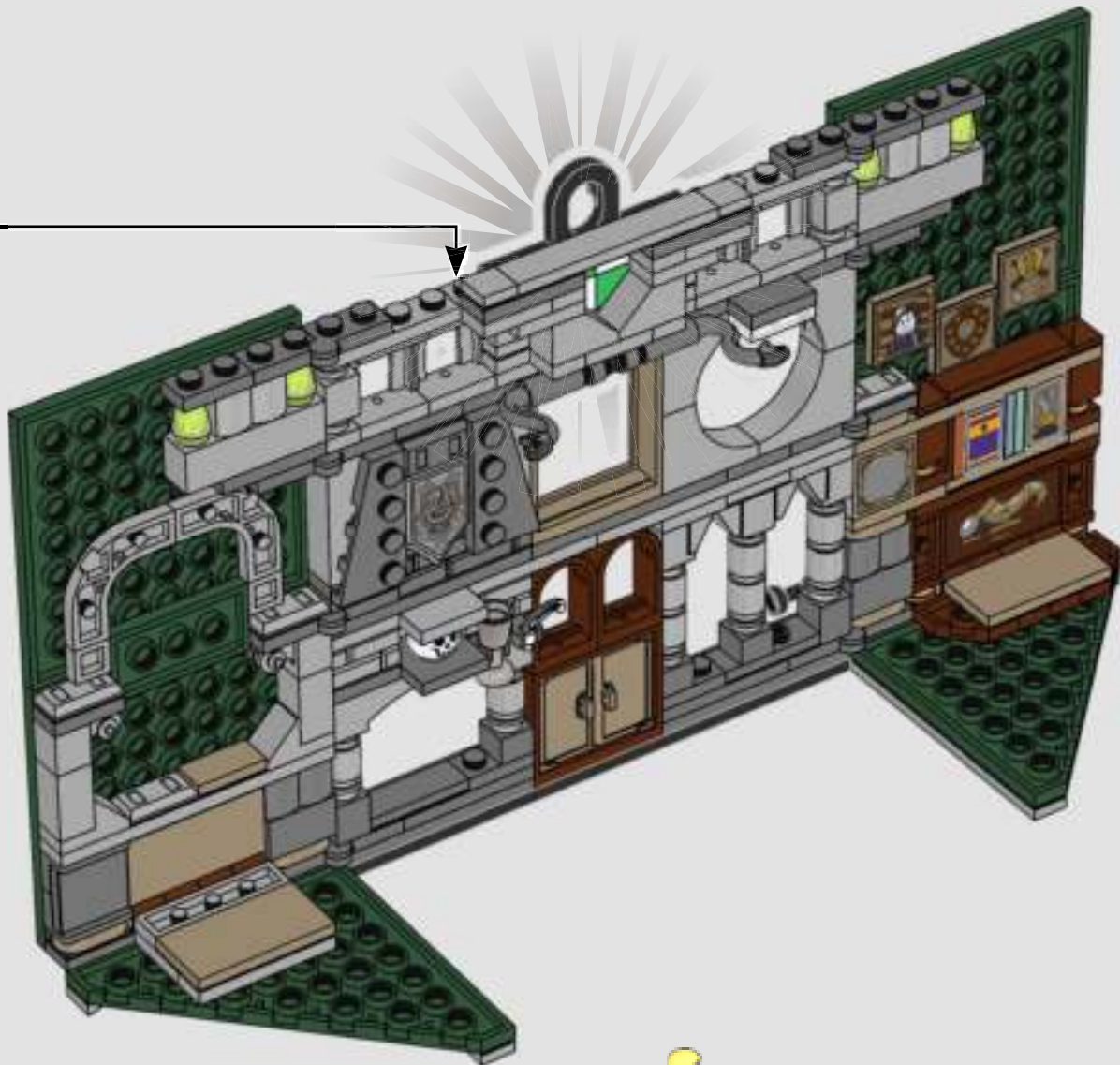



90

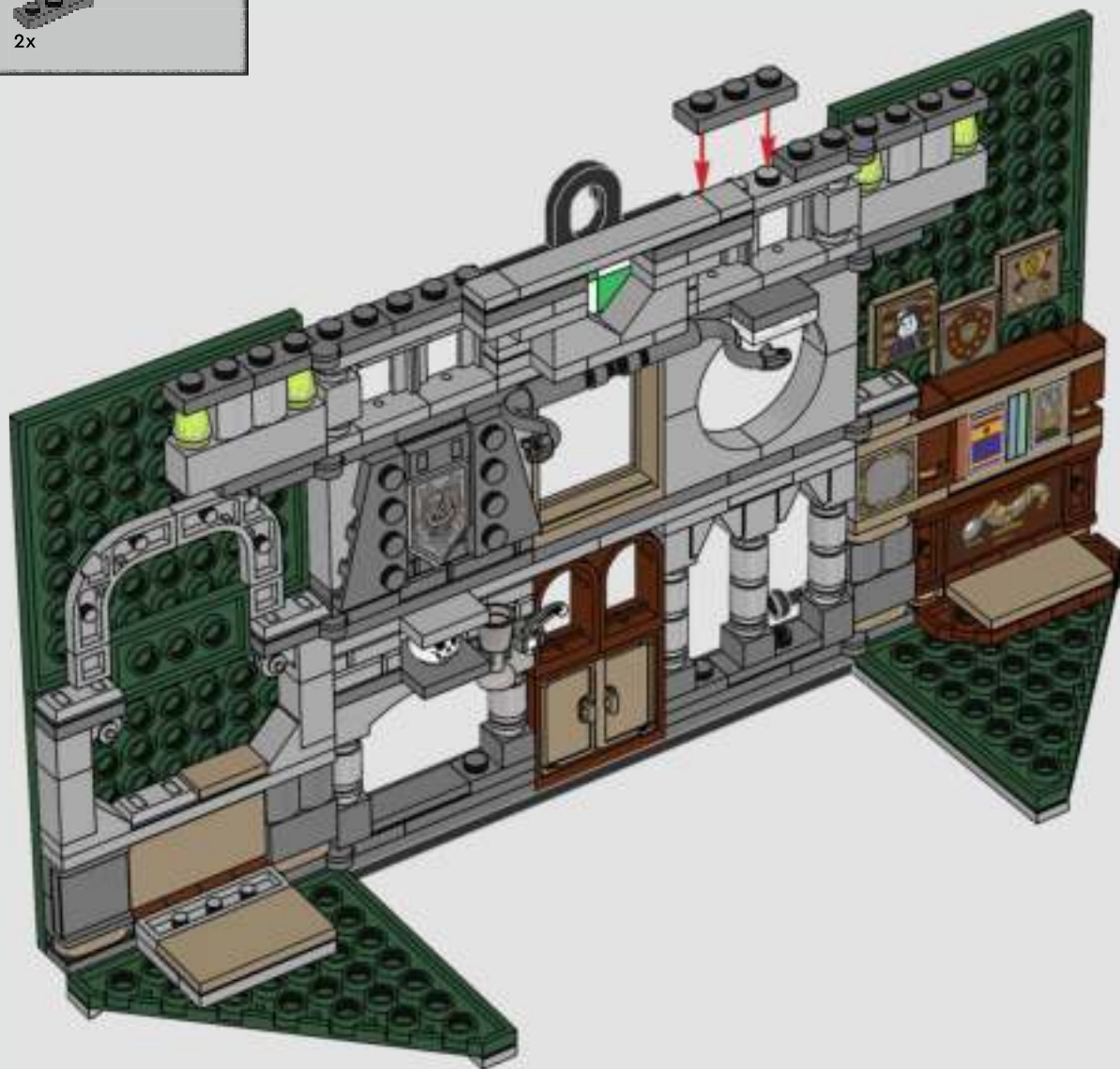



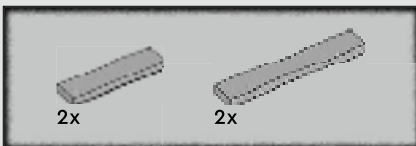

91

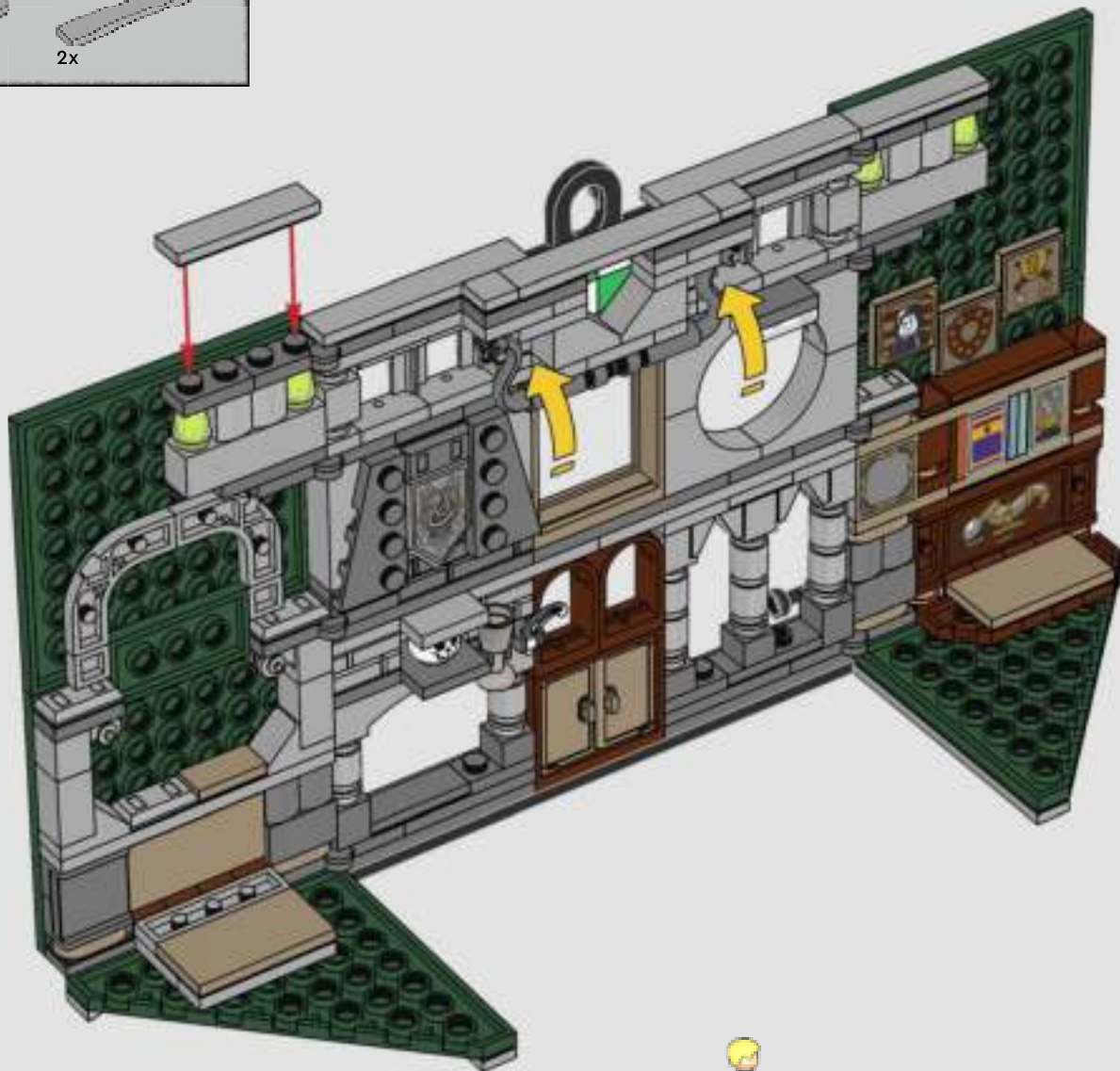

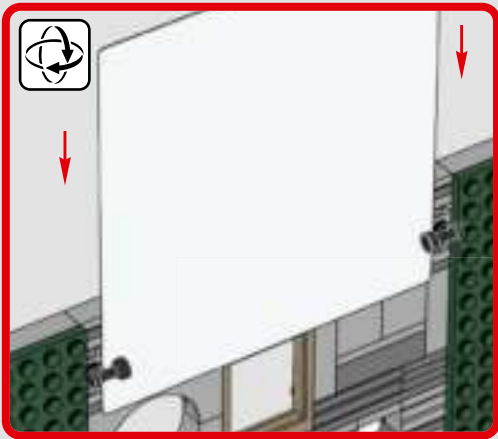

92

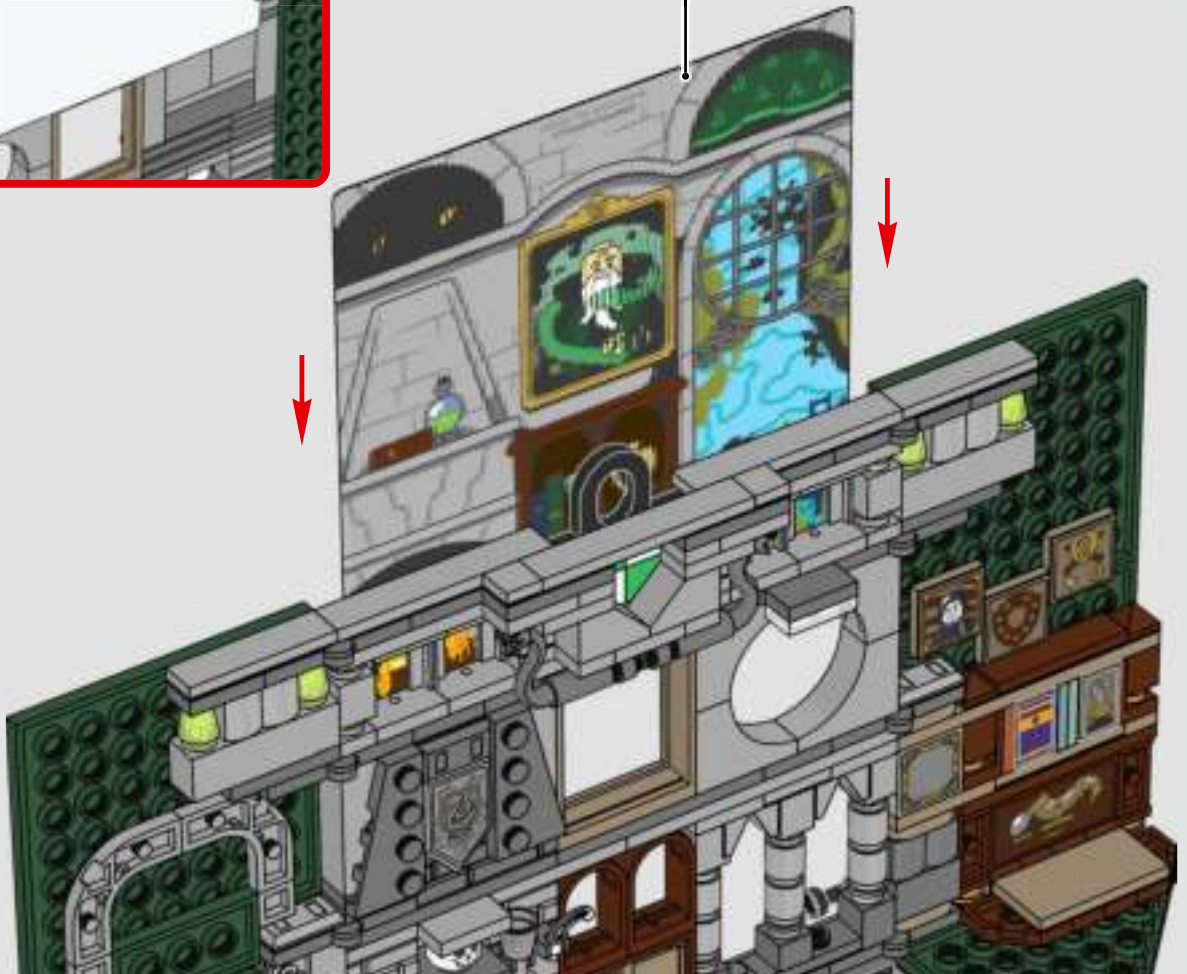
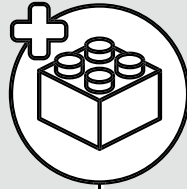

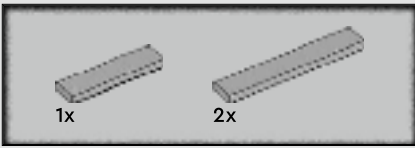

93

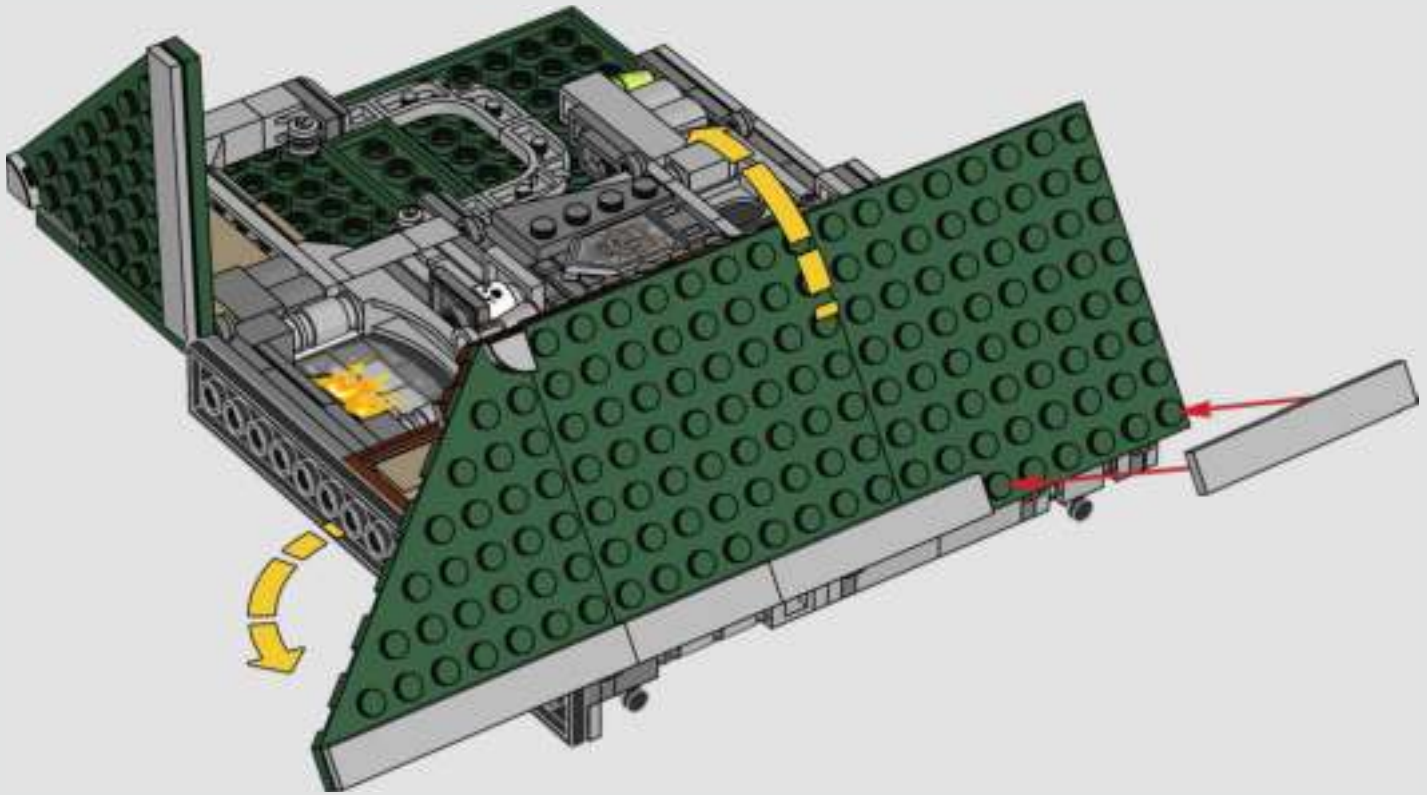

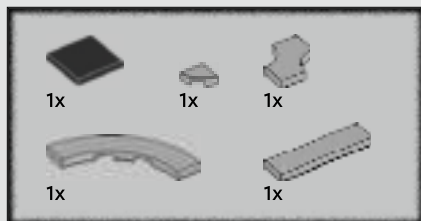

94

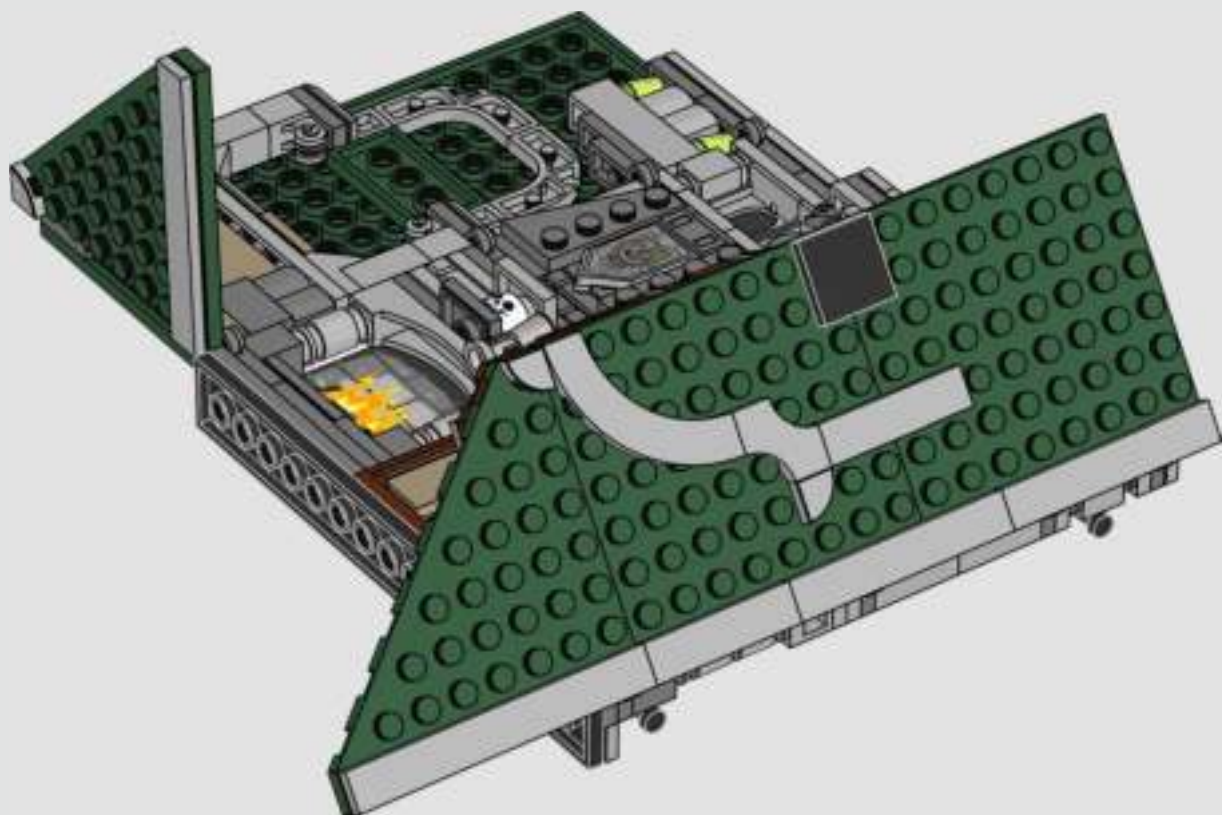





95

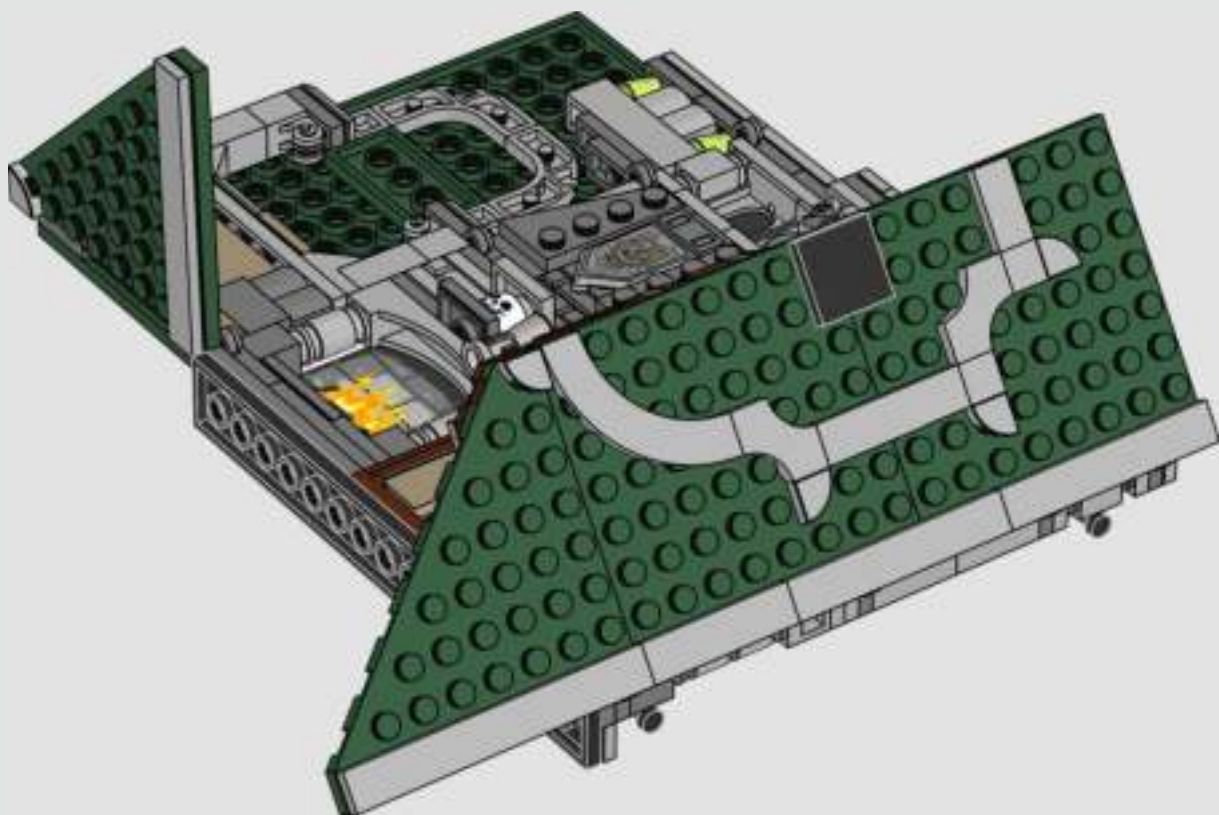

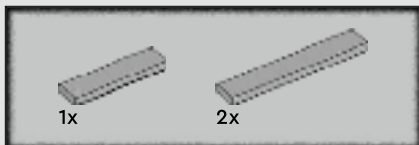

96

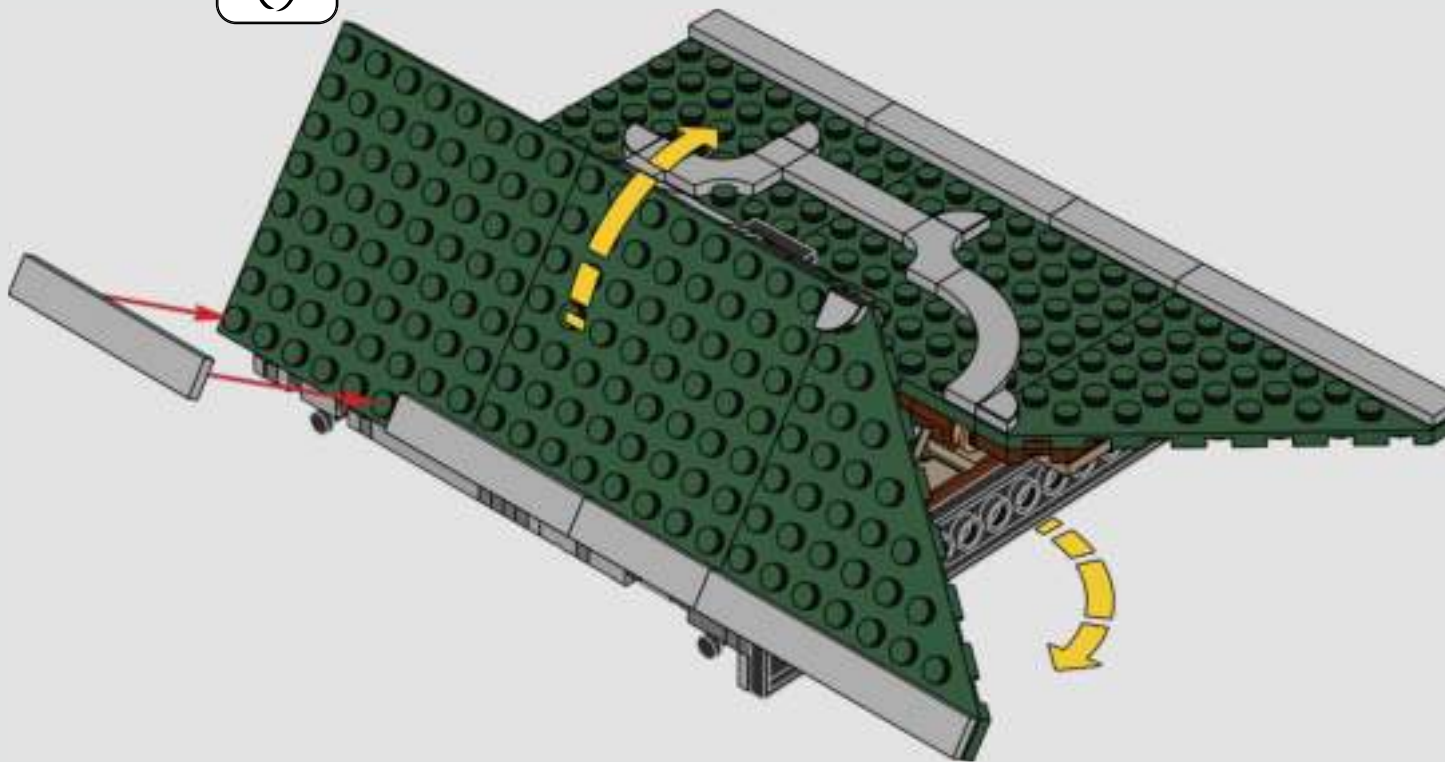

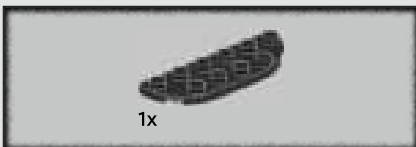

97

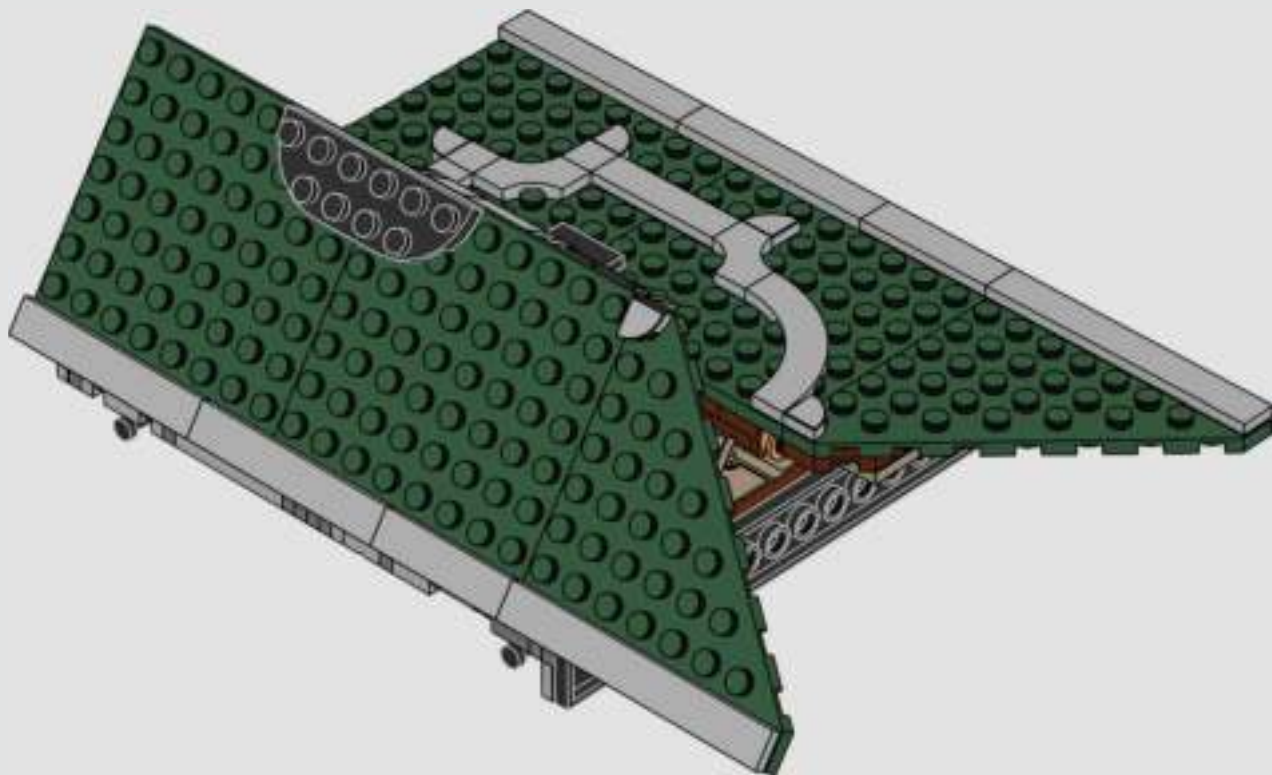

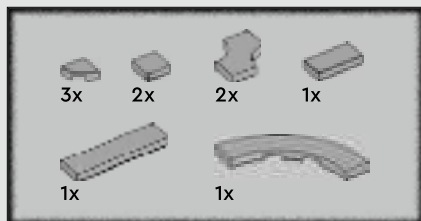

98







99

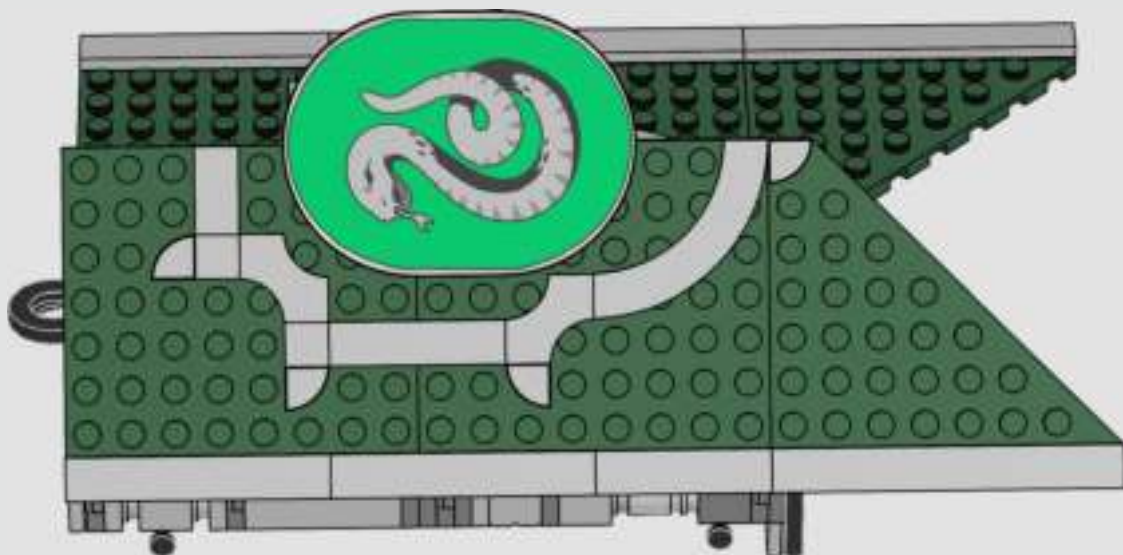

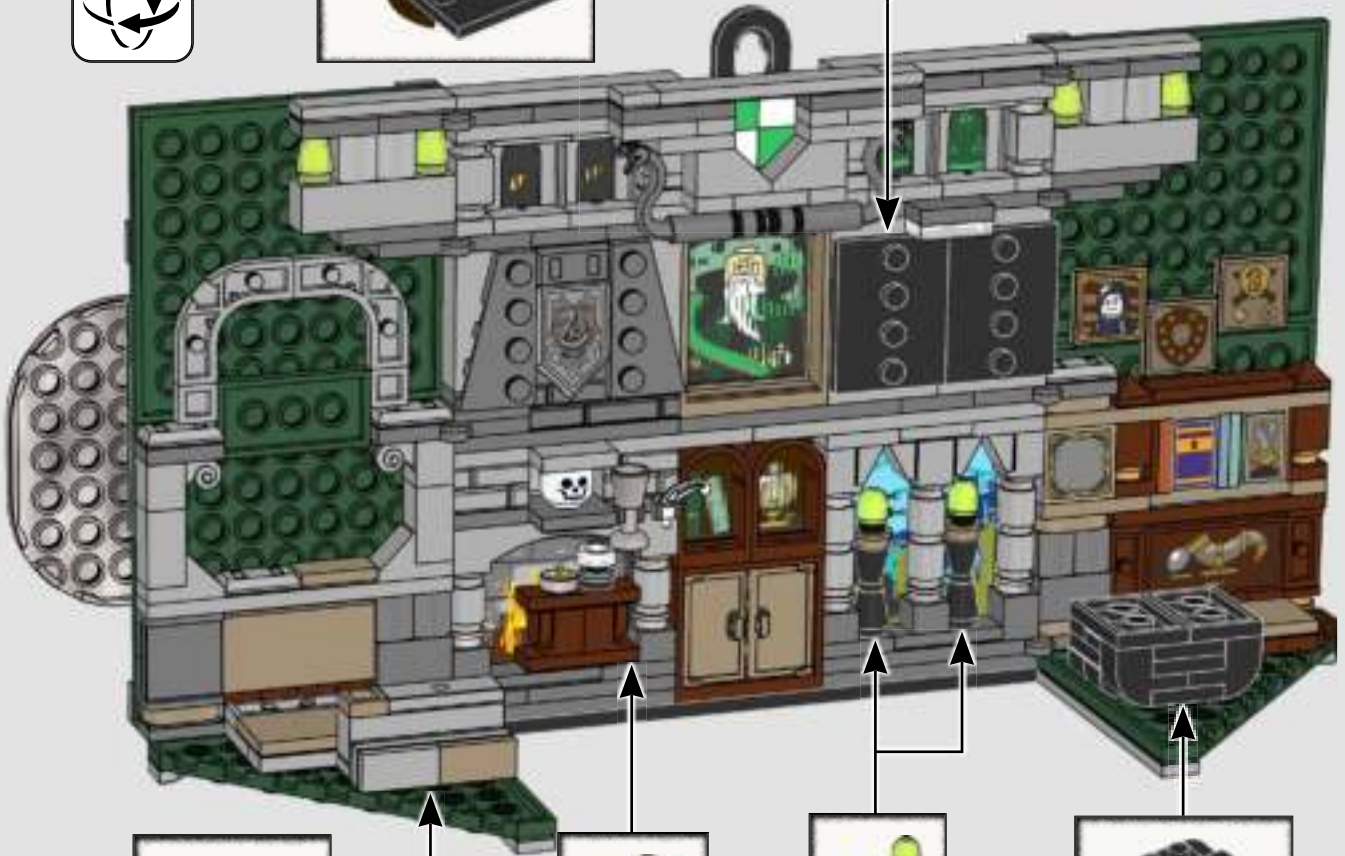

100

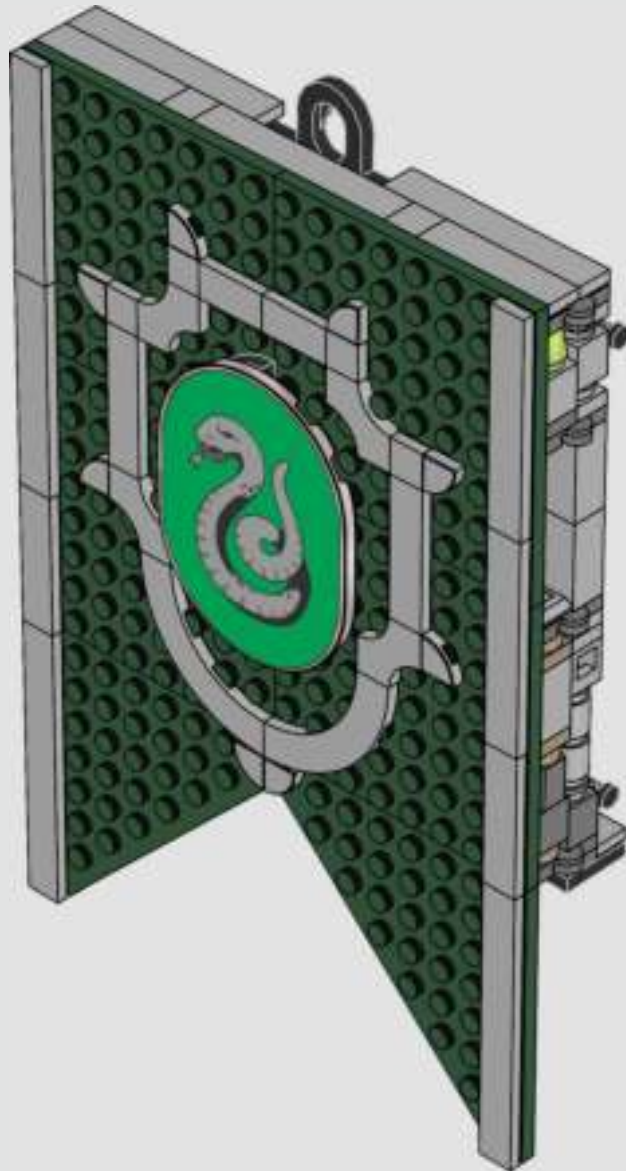







1x 6406415	1x 306826	1x 4570877	1x 6175927	2x 4225469	8x 4211412
1x 4651445	1x 6323536	1x 6186867	3x 6433944	4x 6401027	2x 4211476
2x 307001	1x 6270027	1x 6240204	1x 6156492	2x 6341553	2x 6061702
1x 4107623	2x 302126	1x 6142505	1x 6156492	2x 6218366	8x 6176433
1x 6056234	1x 6254045	2x 6300322	1x 6435236	2x 6218366	4x 4521921
2x 4529236	1x 371026	2x 4549436	1x 4586057	2x 4542131	6x 4211399
1x 6168646	2x 6076678	2x 6428821	2x 6429028	2x 4211150	8x 4211415
4x 459926	1x 6429020	5x 6231386	2x 6429028	8x 6415991	2x 6225242
4x 6273589	1x 6105963	2x 4496699	4x 6429027	2x 6251470	2x 4558953
1x 6356860	1x 428226	2x 6047415	1x 4616578	1x 4211194	1x 4213567
4x 6279875	2x 4558593	3x 6406008	2x 6062574	1x 6433946	4x 6433942
2x 9339	1x 6286433	1x 6132768	2x 6328180	1x 4221590	2x 4550325
2x 6184784		1x 6429029	2x 6328180		2x 6211917
5x 302326			2x 6256734		2x 4211614
2x 300426					

3x  
6123809

2x  
6093859

1x  
6066097

2x  
6000066

5x  
4211398

3x  
4211414

4x  
6134378

4x  
4642934

2x  
6258820

4x  
4211353

1x  
4211397

1x  
6212077

1x  
6245254

1x  
6251044

2x  
6129340

1x  
4211394

6x  
4211356

2x  
4211636

7x  
4211445

2x  
6383110

1x  
6106189

8x  
4211549

1x  
4211438

1x  
4618874

2x  
6163989

4x  
4211481

2x  
4211425

2x  
6388120

3x  
6388133

2x  
4558955

2x  
6234583

2x  
6296892

1x  
4210782

1x  
4210788

2x  
6281996

2x  
4211095

2x  
6230233

1x  
6331866

1x  
4211052

10x  
4211063

2x  
6214341

1x  
6126083

1x  
6013082

1x  
6309059

1x  
4568734

1x  
6435239

1x  
6343852

8x  
4211133

1x  
6271127

1x  
4211103

2x  
4211001

1x  
6055310

8x  
6416526

4x  
4211056

1x  
6309172

1x  
6420370

1x  
6420343

4x  
4523159

1x  
4527065

2x  
6270032

2x  
6005030

2x  
6171864

4x  
6337628



1x  
6448403



1x  
6420345



1x  
6420348



14x  
4633691



1x  
6107389



1x  
6403206



 [LEGO.com/service](https://www.LEGO.com/service)



YOU COULD **WIN**



Scan this QR code or go to **LEGO.COM/PRODUCTFEEDBACK** and give us your short feedback about this LEGO® set for a chance to win a cool LEGO prize.

Terms and Conditions apply\*

**DE: Du könntest GEWINNEN.** Es gelten die Teilnahmebedingungen\* **FR: Tu pourrais GAGNER.** Des conditions s'appliquent\* **IT: Potresti VINCERE tu.** Termini e condizioni sono applicabili\* **ES: Puedes GANAR.** Aplican términos y condiciones\* **PT: Poderá GANHAR.** Aplicam-se termos e condições\* **JA: プレゼント付き! 利用規約が適用されます\*** **ZH: 轻松获奖. 条款和条件适用\*** **KO: 상품의 주인이 되어보세요. 소정의 약관이 적용됩니다\*** **RU: Вы можете ВЫИГРАТЬ.** Действуют положения и условия\* **PL: Szansa na WYGRANĄ.** Obowiązują warunki korzystania\* **CS: Máte šanci VYHRÁT.** Platí všeobecné smluvní podmínky\* **SK: Máte šancu VYHRAŤ.** Platia všeobecné zmluvné podmienky\* **HU: TE IS NYERHETSZ.** Felhasználási feltételek érvényesek\* **RO: Ai putea CÂȘTIGA.** Se aplică termeni și condiții\* **BG: Можете да СПЕЧЕЛИТЕ.** Има определени правила и условия\* **LV: Tu vari LAIMĒT.** Ir spēkā noteikumi un nosacījumi.\* **ET: Sul on võimalus VÕITA.** Kehtivad tingimused\* **LT: Jūs galite LAIMĖTI.** Taikomos sąlygos\*  
\*LEGO.com/productfeedback-terms

LEGO and the LEGO logo are trademarks of the LEGO Group. ©2023 The LEGO Group.

WIZARDING WORLD and all related trademarks, characters, names, and indicia are © & ™ Warner Bros. Entertainment Inc. Publishing Rights © JKR. (s23)