



**SPEED**  
CHAMPIONS

76916





 **FR**  
**DONNEZ**  
OU  
**RECYCLEZ**

 OU  OU 

ASSOCIATION    MAGASIN    DÉCHÈTERIE

Adresses sur [quefairedemesdechets.fr](http://quefairedemesdechets.fr)



[LEGO.com/sustainable-packaging](https://LEGO.com/sustainable-packaging)



# BUILDER



Apple and the Apple logo are trademarks of Apple Inc., registered in the U.S. and other countries and regions. App Store is a service mark of Apple Inc. Google Play and the Google Play logo are trademarks of Google LLC. Tencent and the Tencent logo are trademarks of Tencent Inc.

EN Ask parents' permission before going online | DE Eltern um Erlaubnis bitten, bevor du online gehst | FR Demande l'autorisation d'un parent avant d'aller en ligne | IT Chiedi il permesso ai tuoi genitori prima di andare online | ES Pídeles permiso a tus papás antes de conectarte a Internet | PT Pede autorização aos pais antes de acederes online | JA オンラインになる前にほご者の方のきよかをもらおう | ZH 上网前应先征得父母的同意 | KO 온라인 접속 전에 보호자 동의가 필요합니다 | RU Спроси разрешения у родителей, прежде чем заходить в интернет | PL Poproś rodziców o zgodę, zanim wejdiesz do Internetu | CS Než půjdeš na internet, požádej rodiče o svolení | SK Skôr než pôjdeš na internet, vypýtaj si povolenie od rodičov | HU Kérj szülői engedélyt, mielőtt online csatlakoznál! | RO Cere permisiunea părinților înainte de a te conecta online | BG Поискайте разрешение от родител, преди да влезете онлайн | LV Pirms došanās tiešsaistē palūdz atļauju vecākiem | ET Enne Interneti kasutamist küsi vanematelt luba | LT Prieš prisijungdami prie interneto, atsklauskite tėvų

Q [LEGO.com/devicecheck](https://www.lego.com/devicecheck)

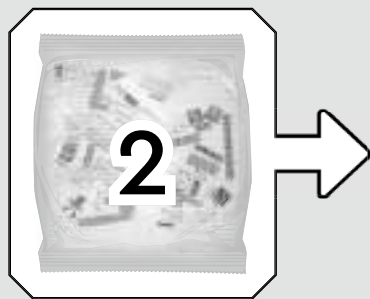
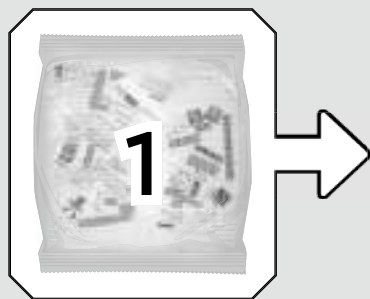

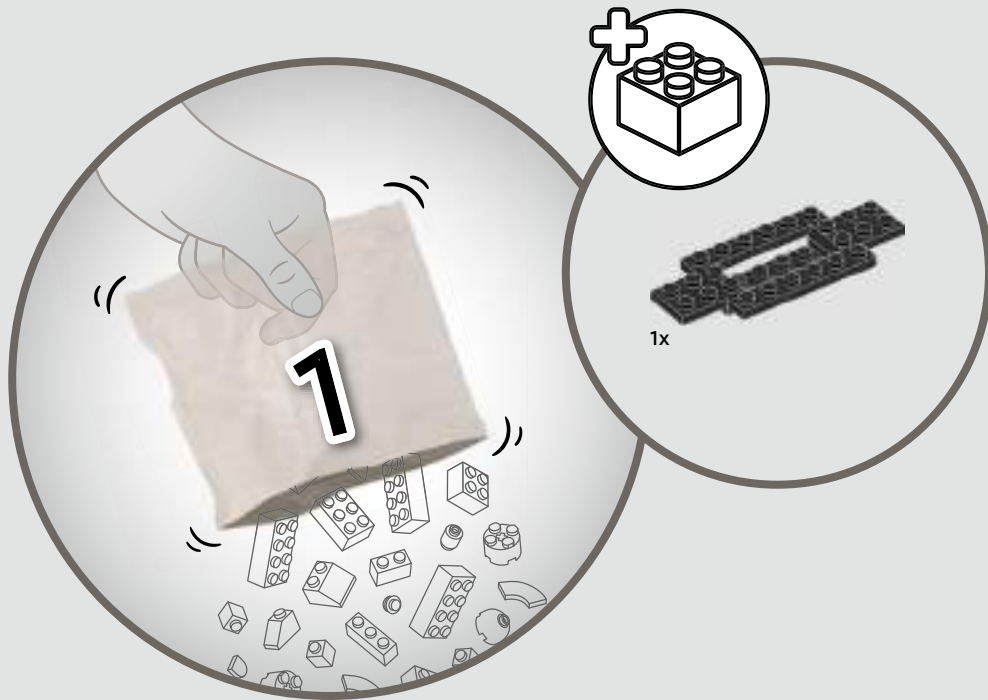

1

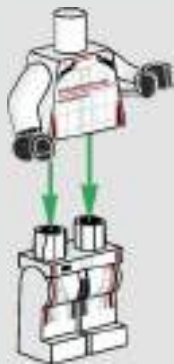

2



3





4

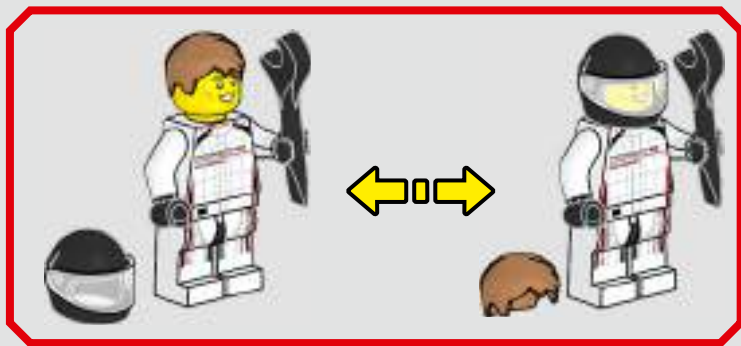
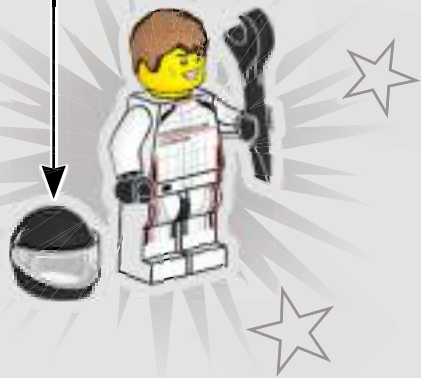

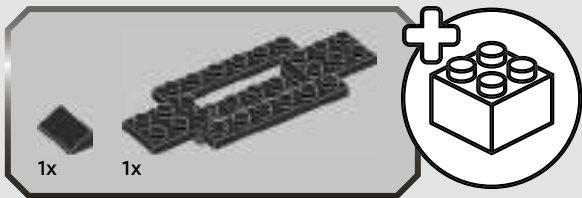
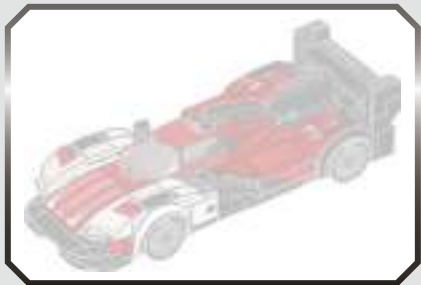

1

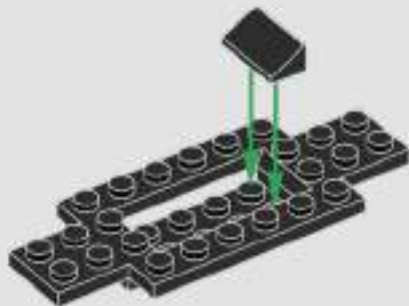





2

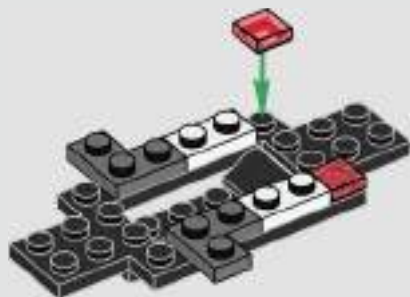

3

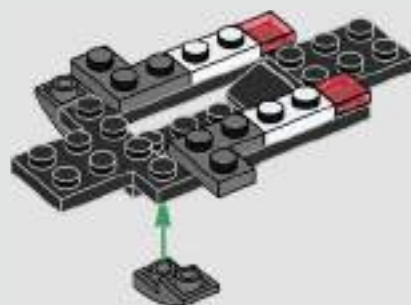



2x

4

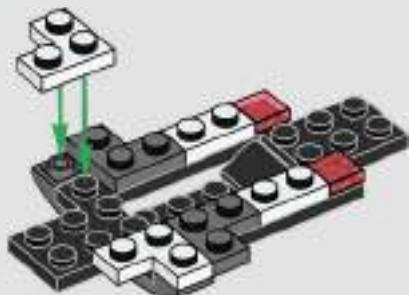

1x



1x

5

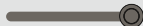
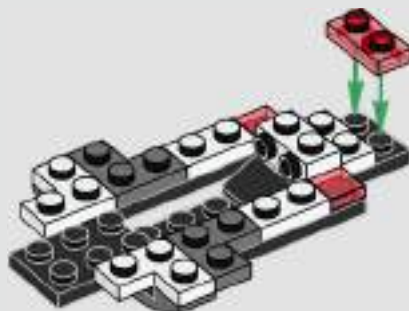



6

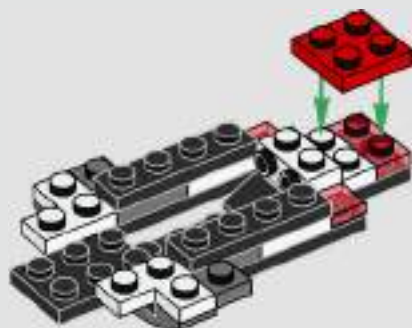

7





8

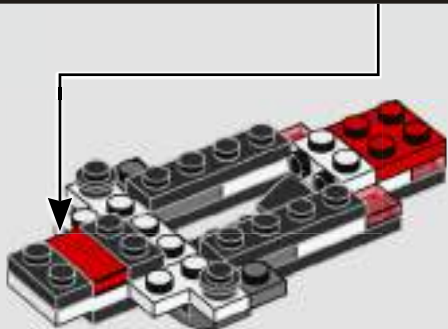

9

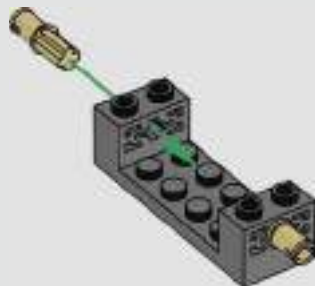



10

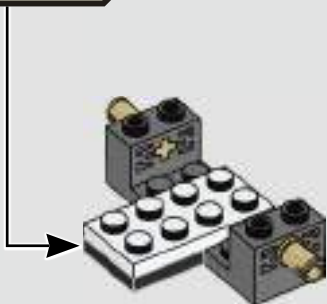
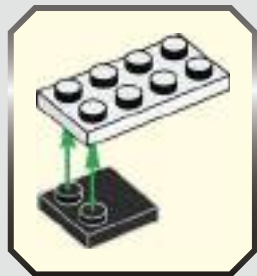

11

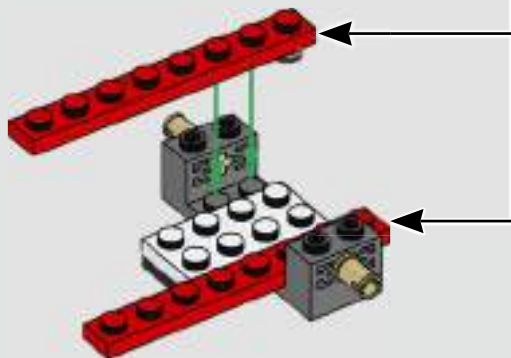
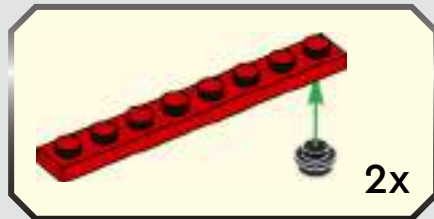

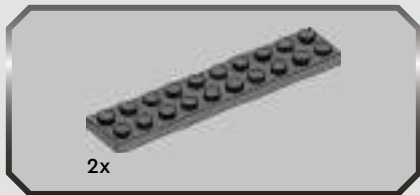

12

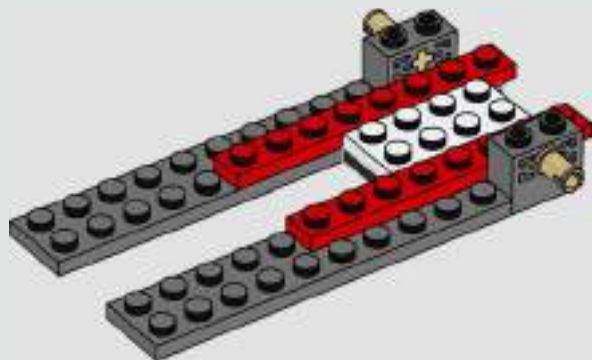

13

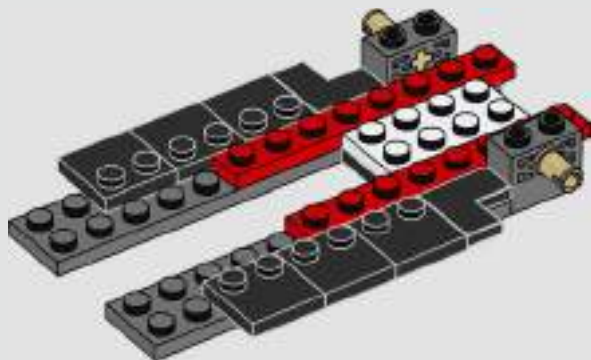



14

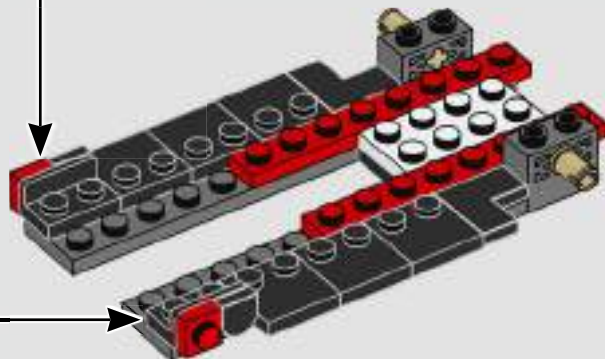
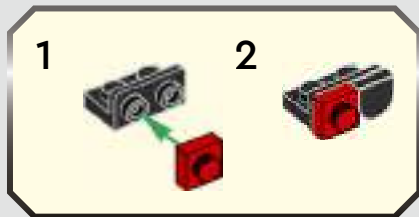
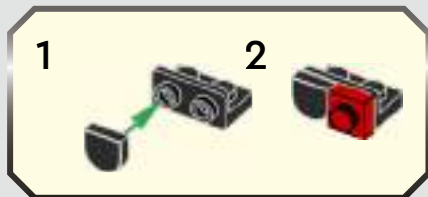

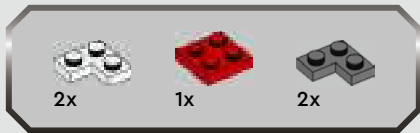

15

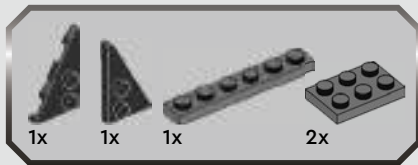
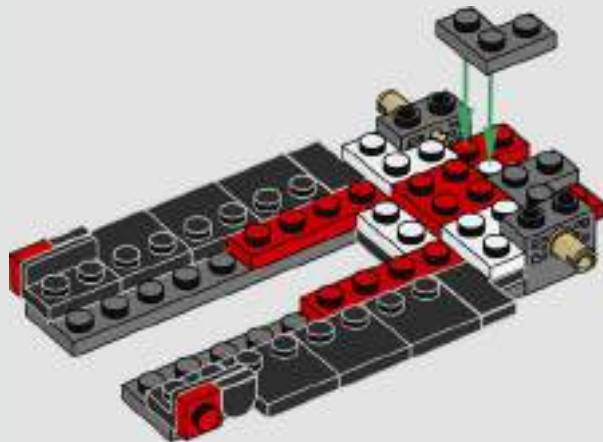

16

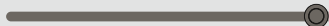
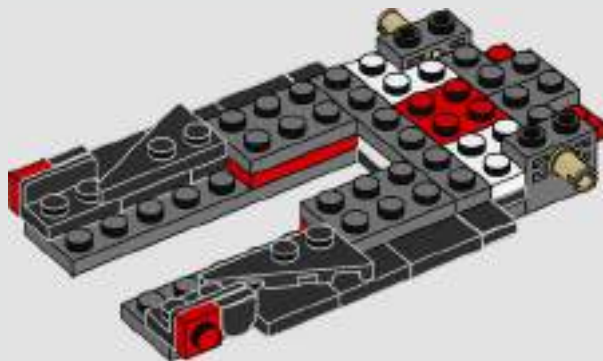





17

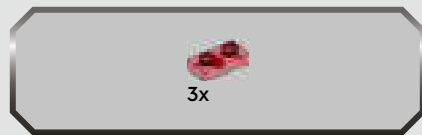
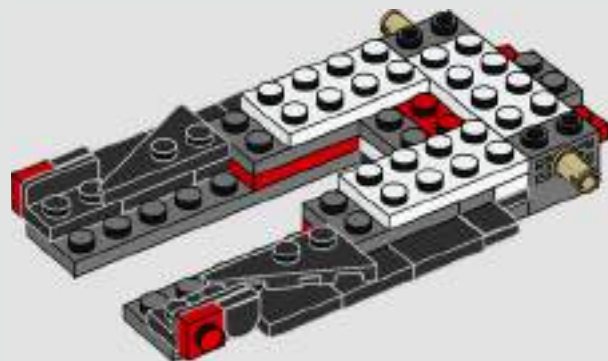

18

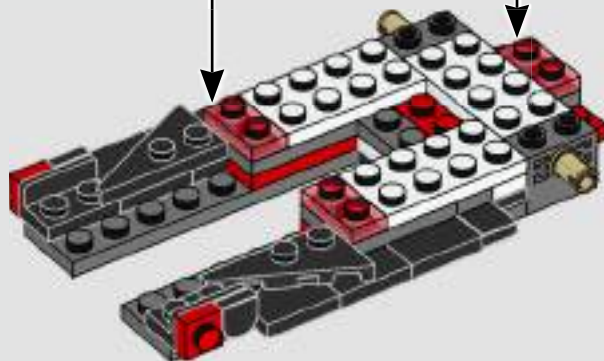



19



20

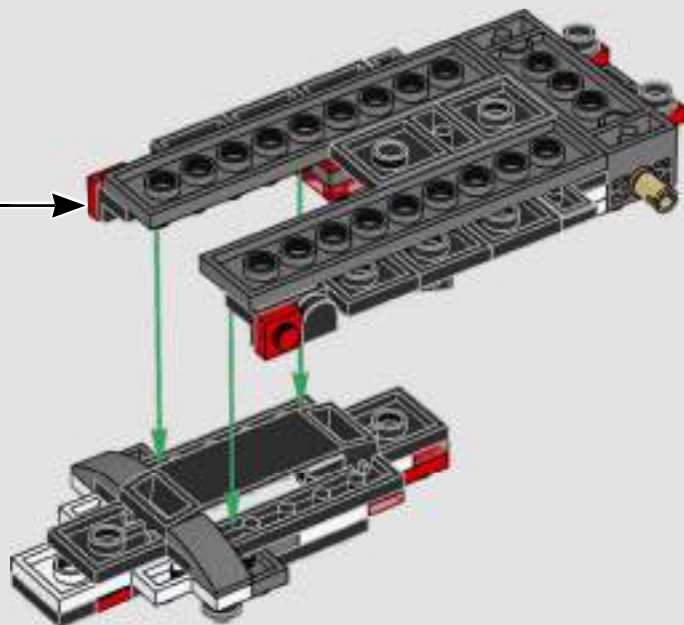

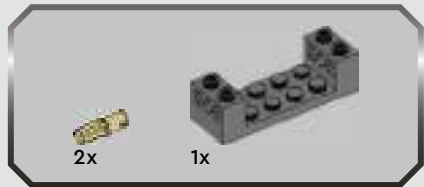

21

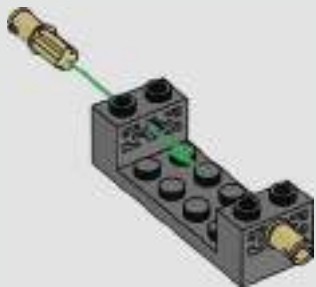

22

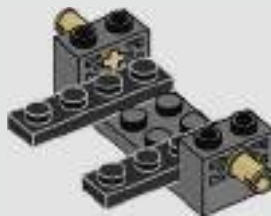



23

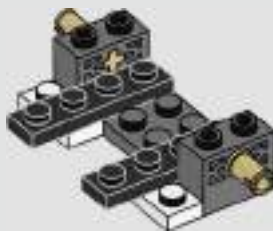

24

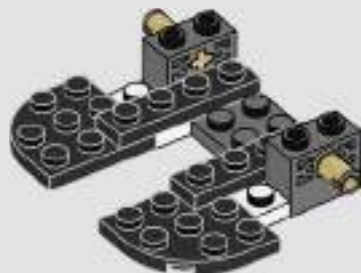

2x

2x

25



2x

26



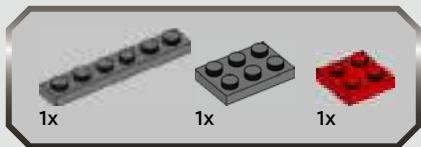

27

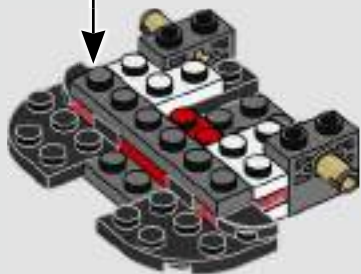

28





29



30

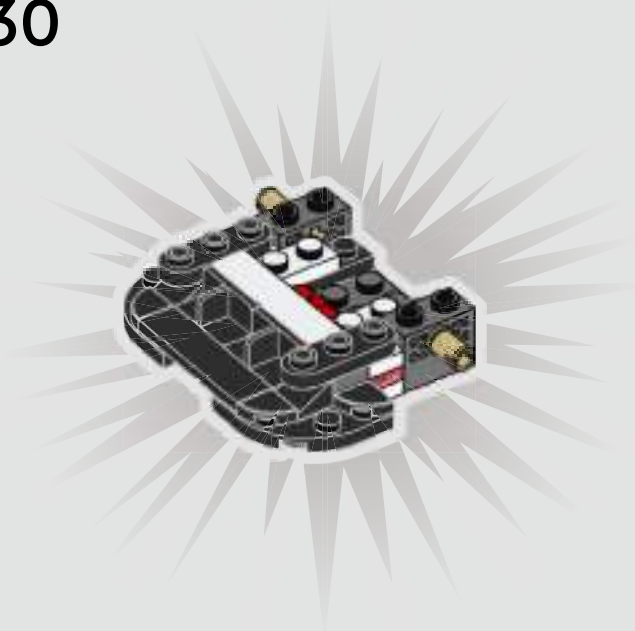



31

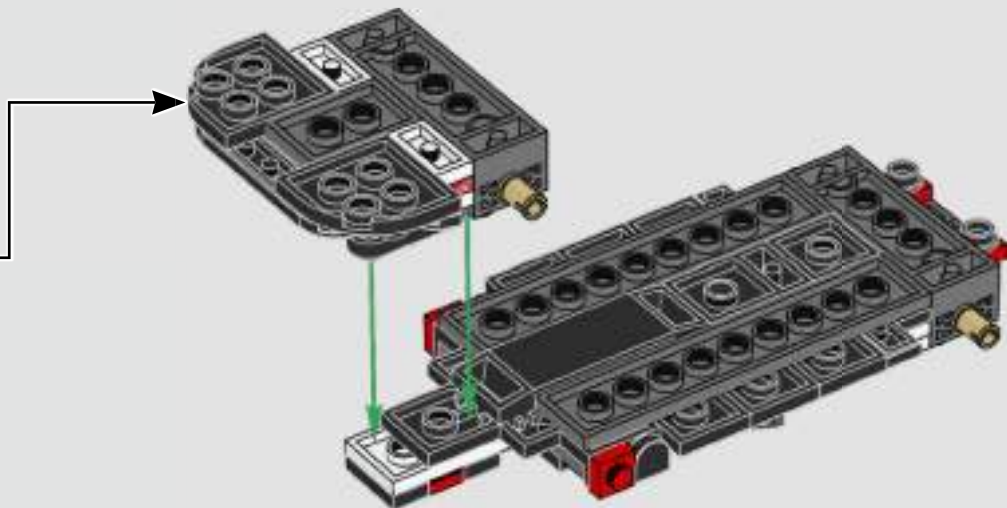



2x



1x

# 32

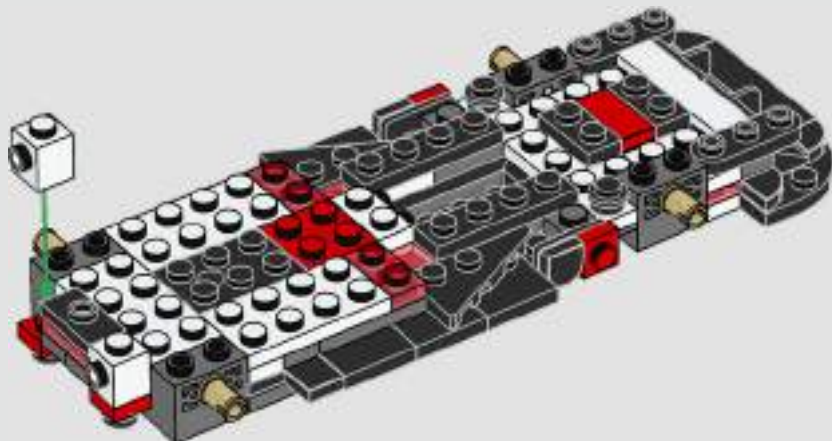

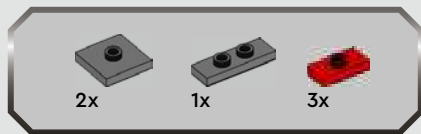

33

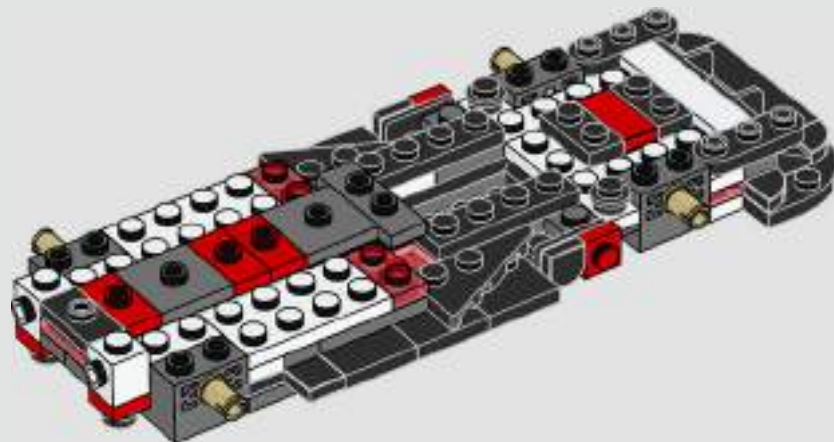



34

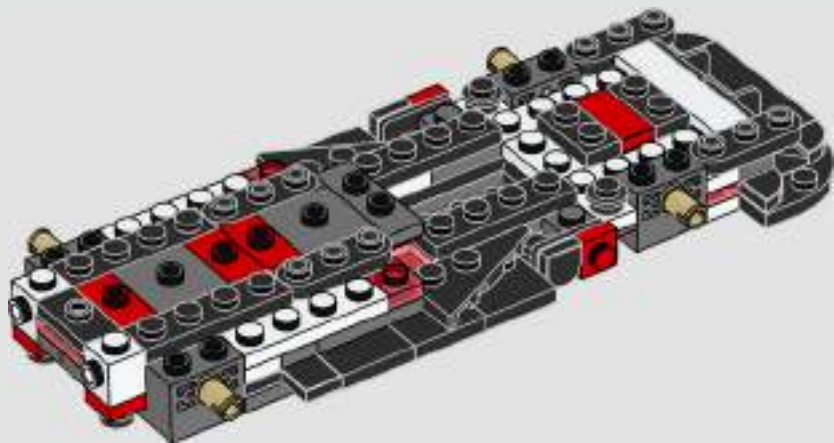



2x

35

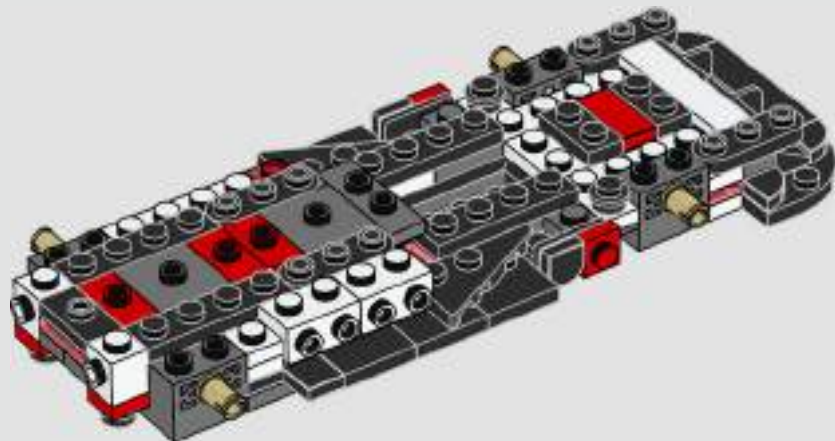



36

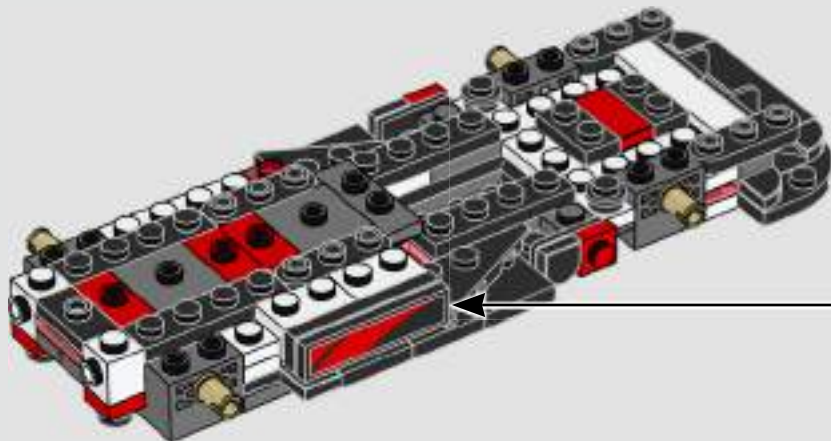
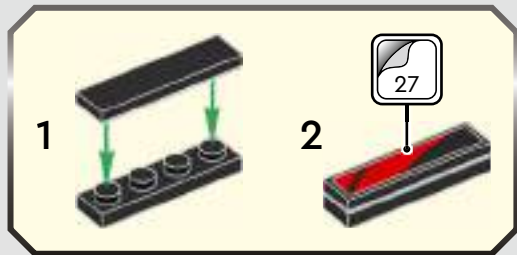



37

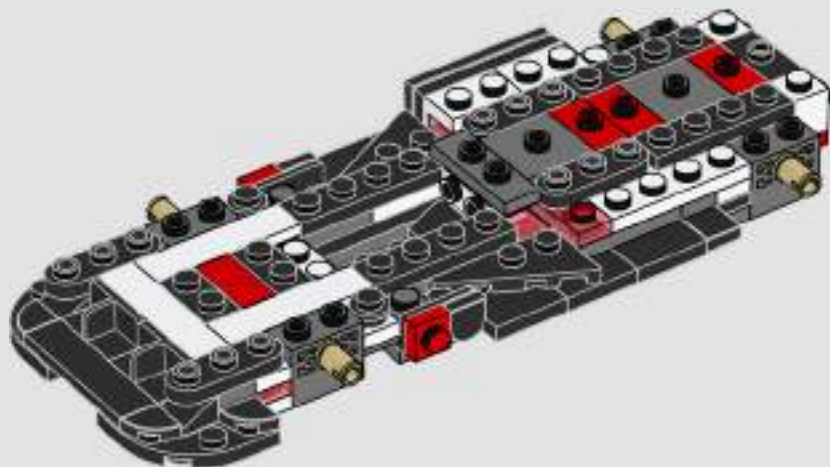



2x

38

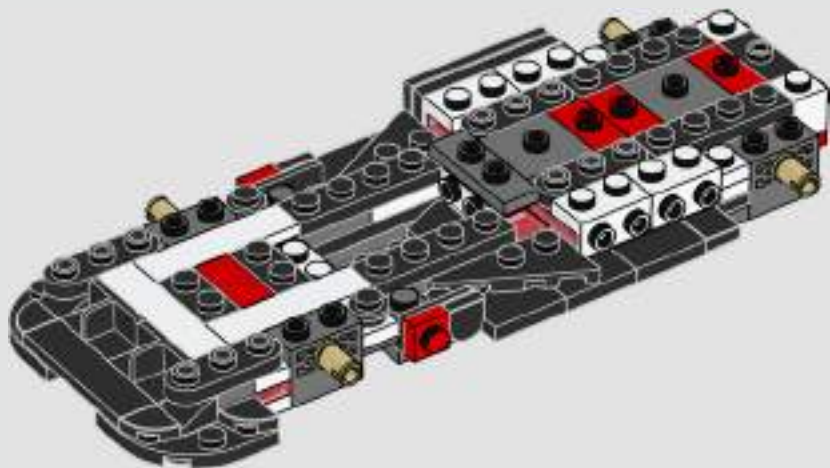





# 39

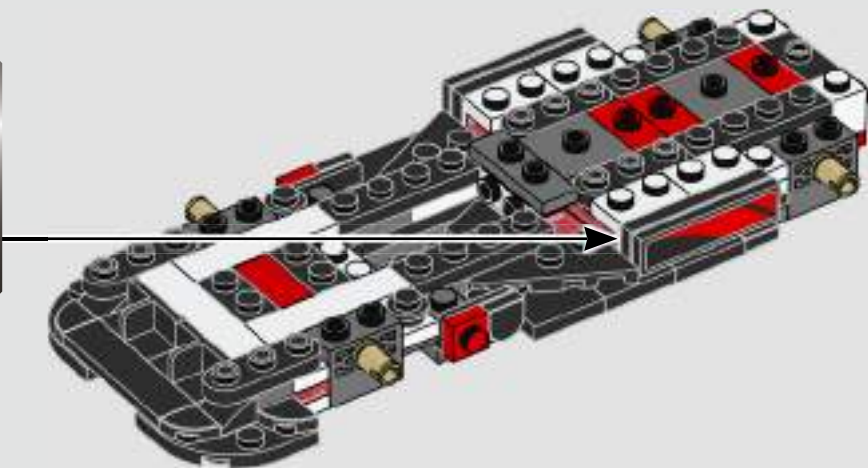
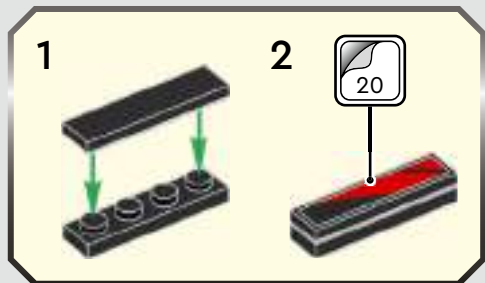



40

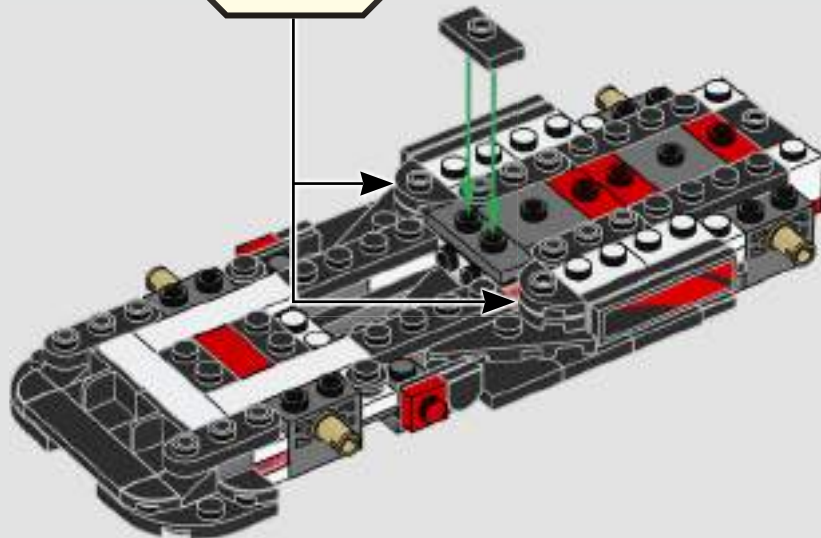



41

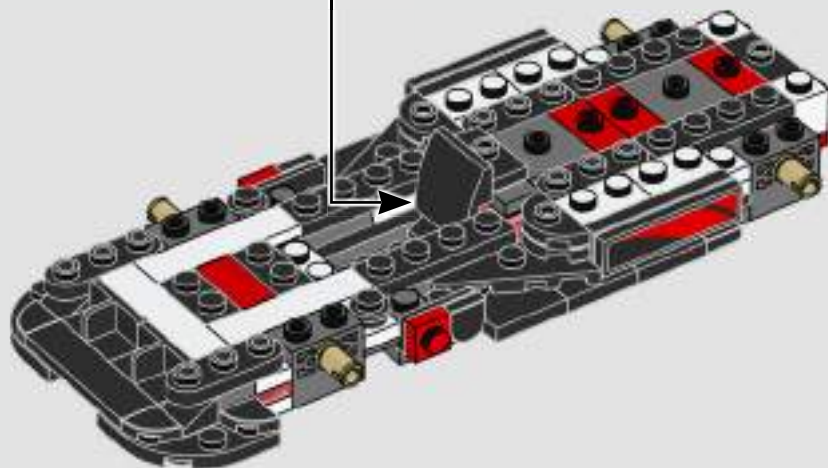

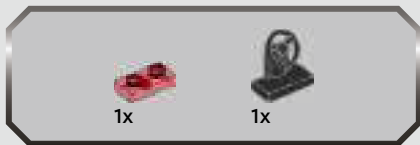

42

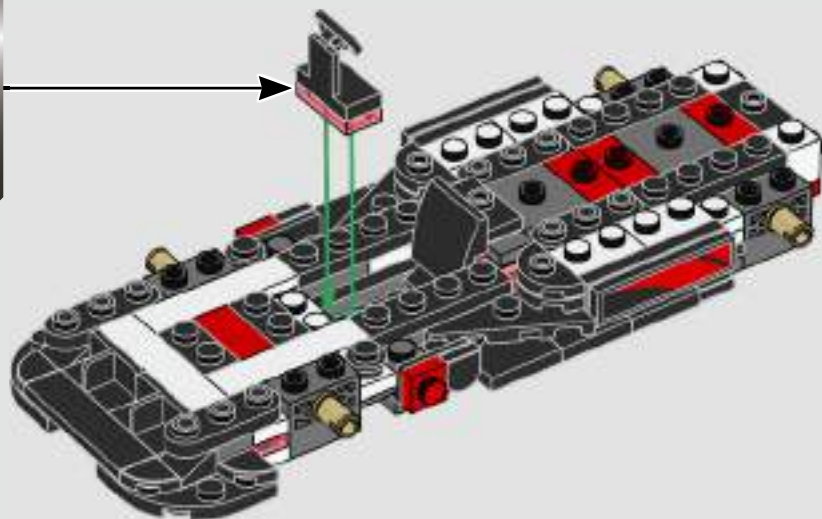



1x

43

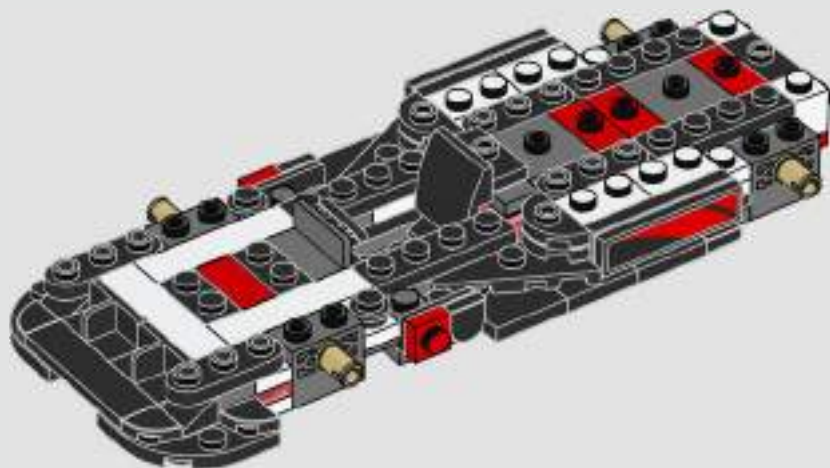

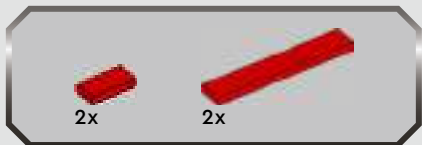

44

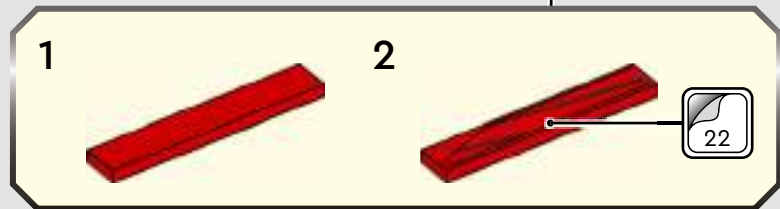
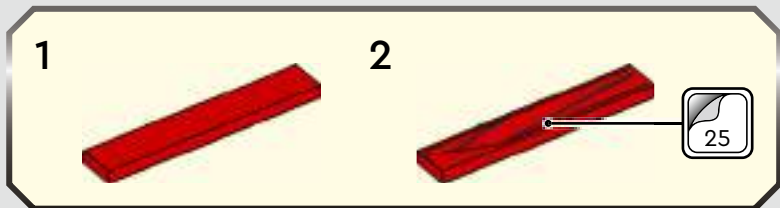
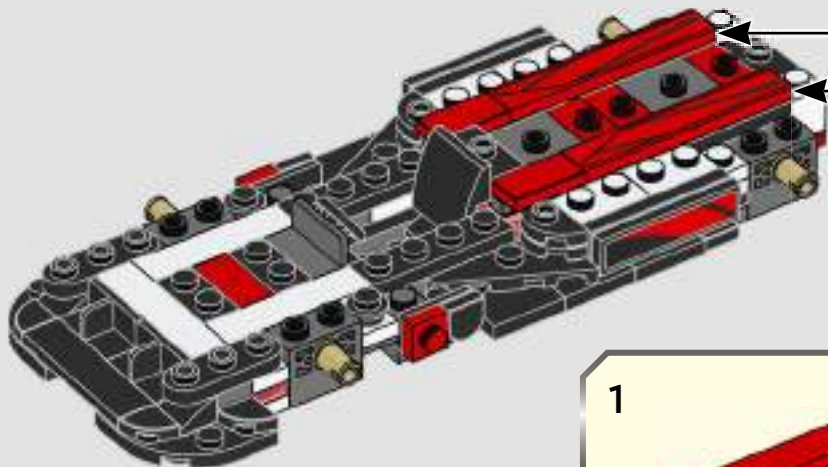



45

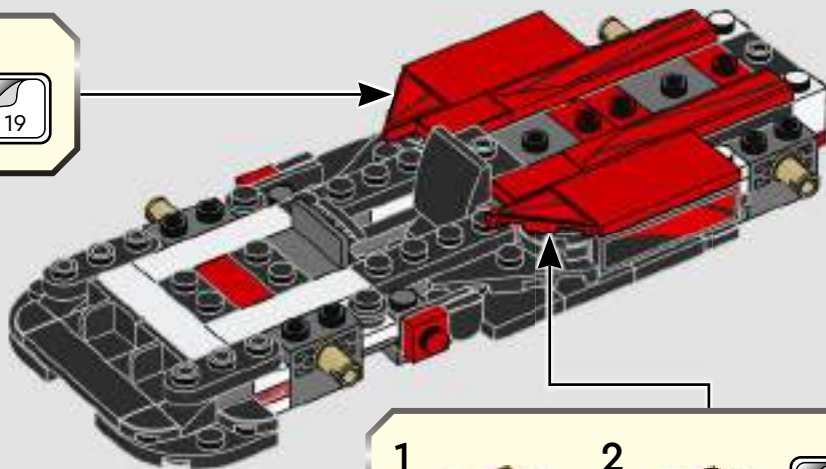
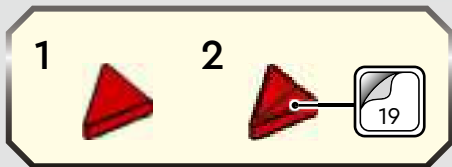



46

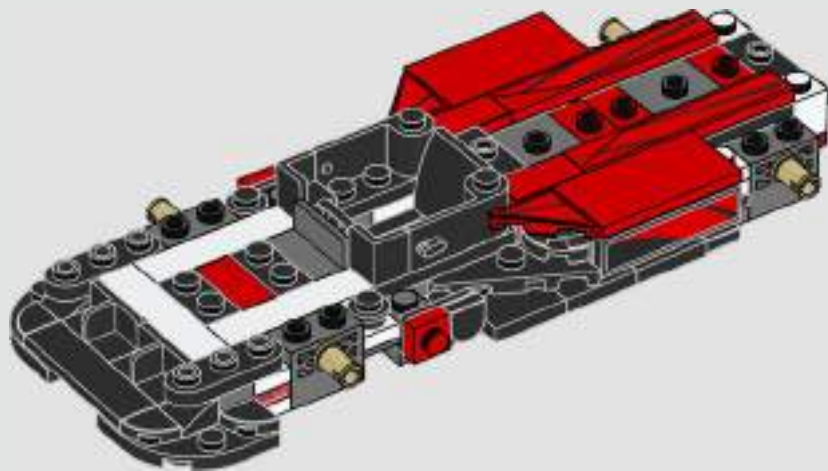







2x

47

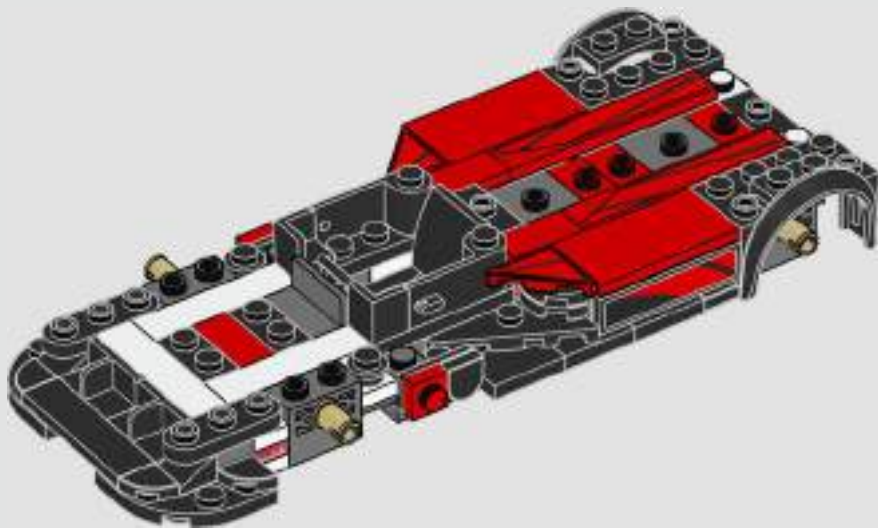

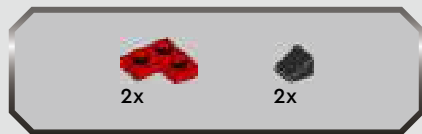

48

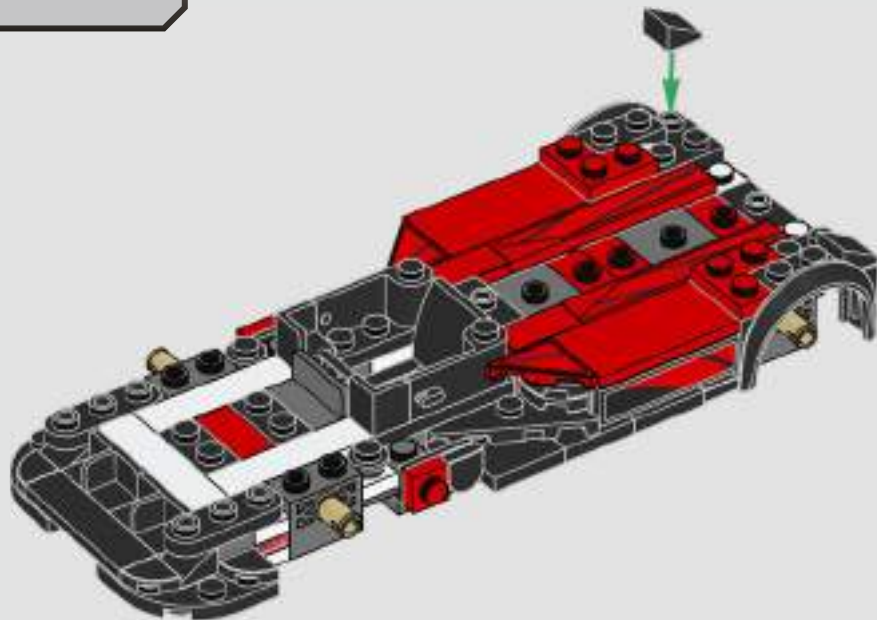

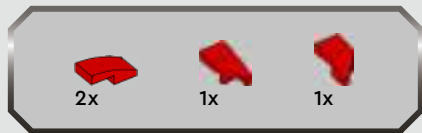

49

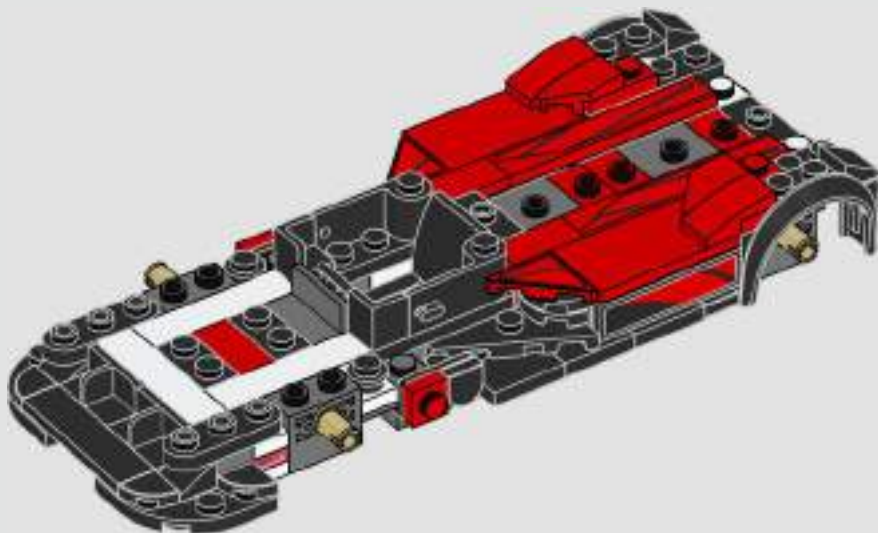

50

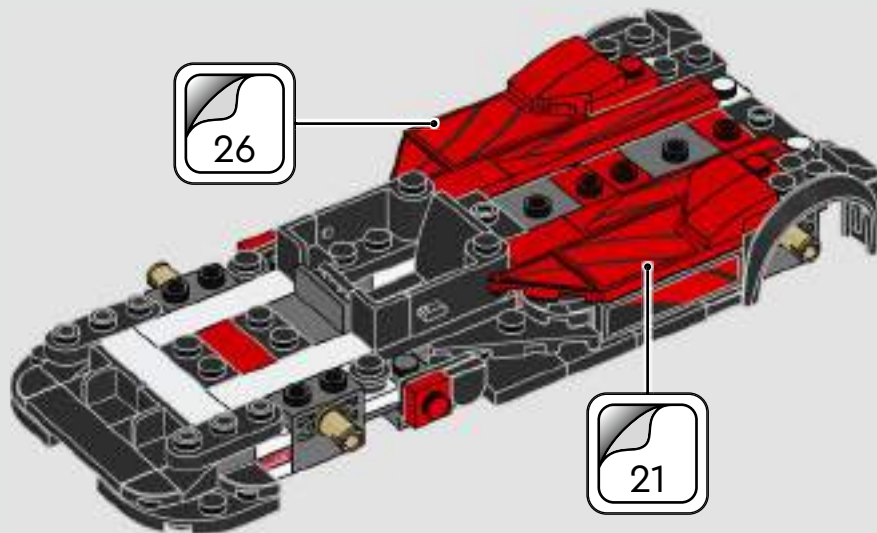

51

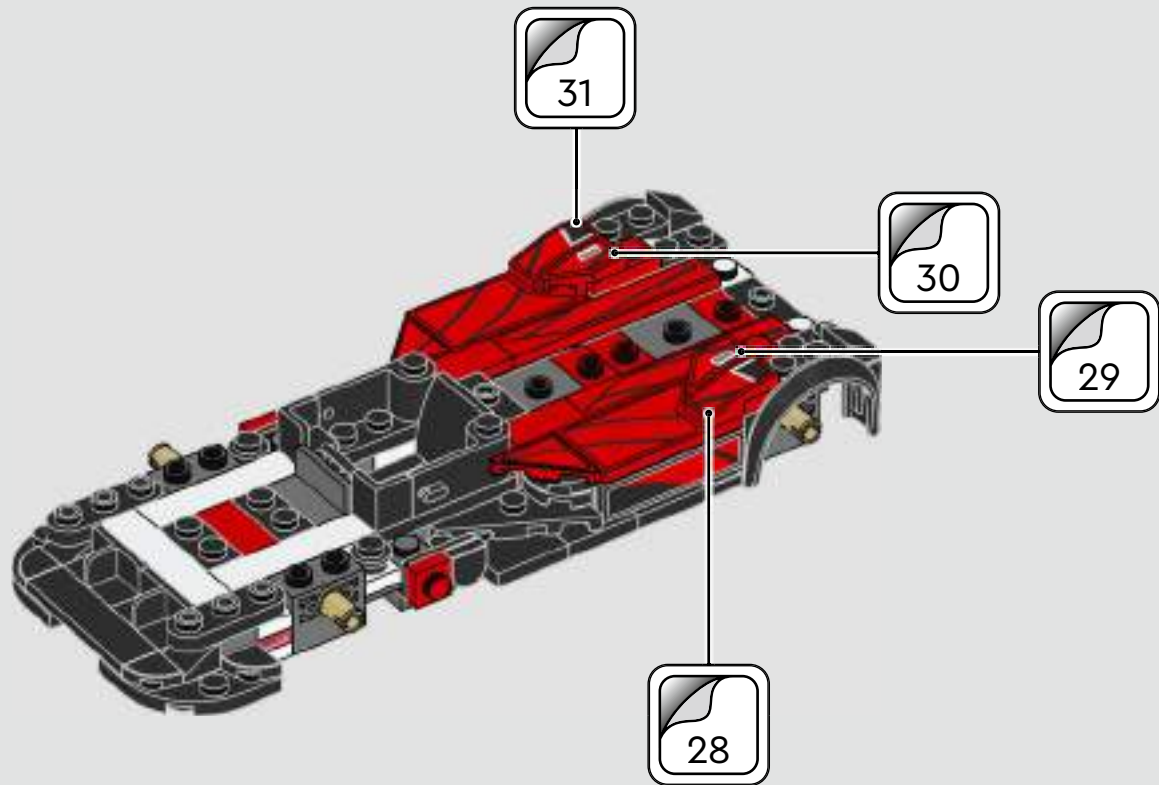



2x



2x

# 52

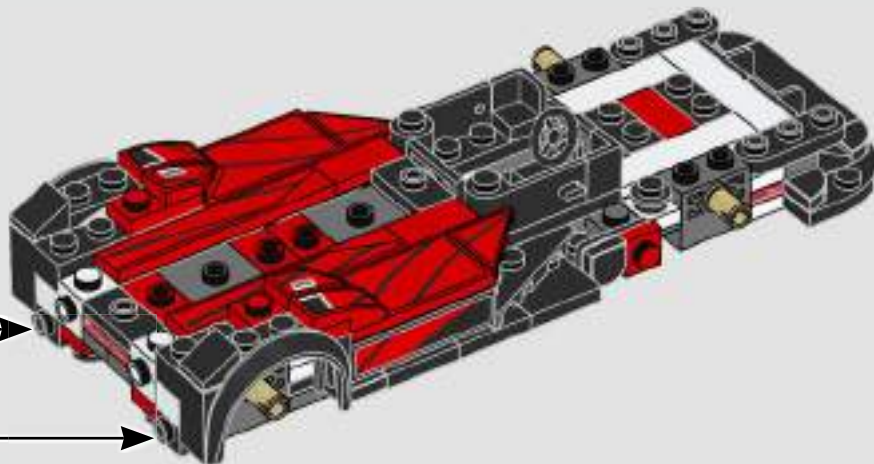
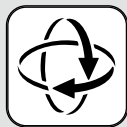



2x

53



2x

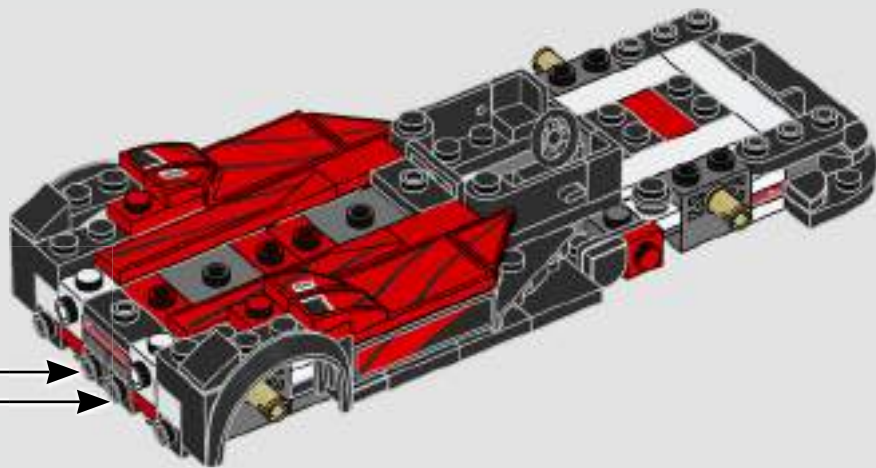





54

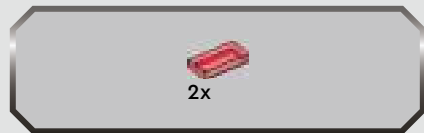

55

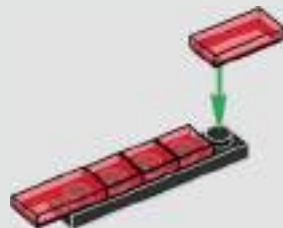

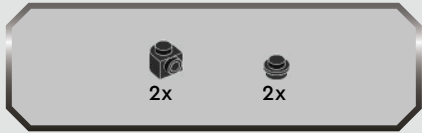

56

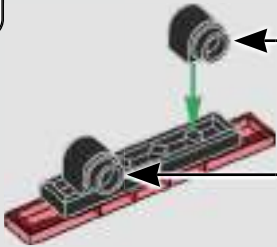

57

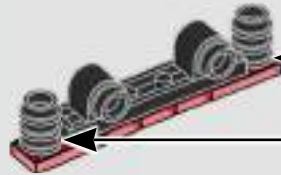
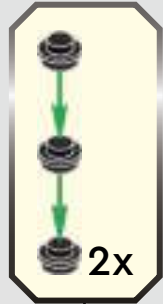

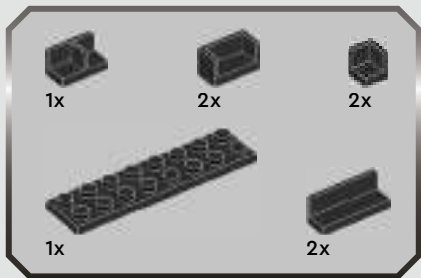

58

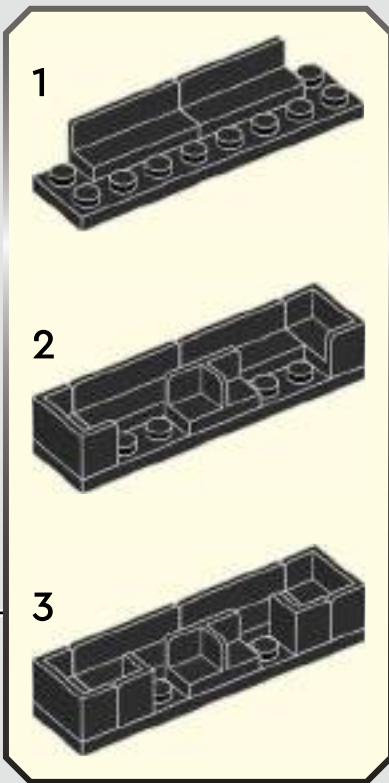
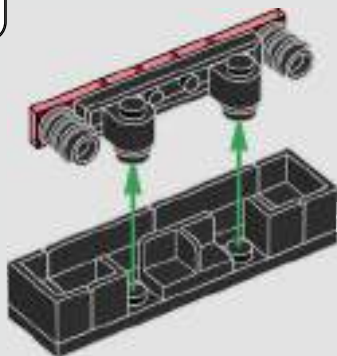

59

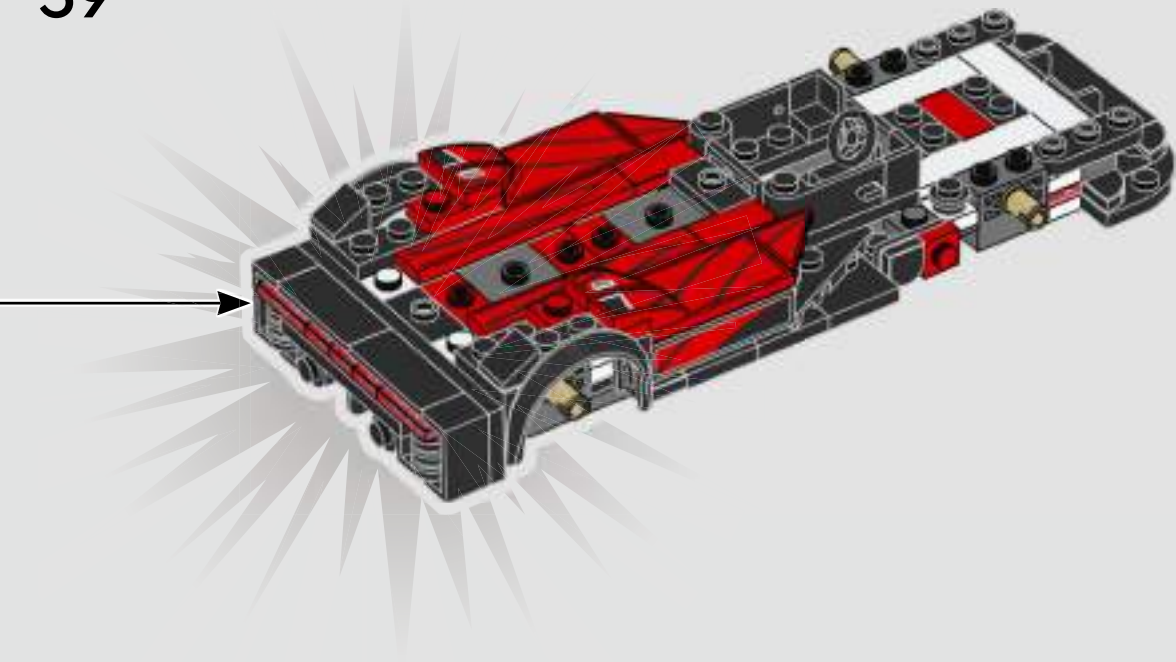



2x

60

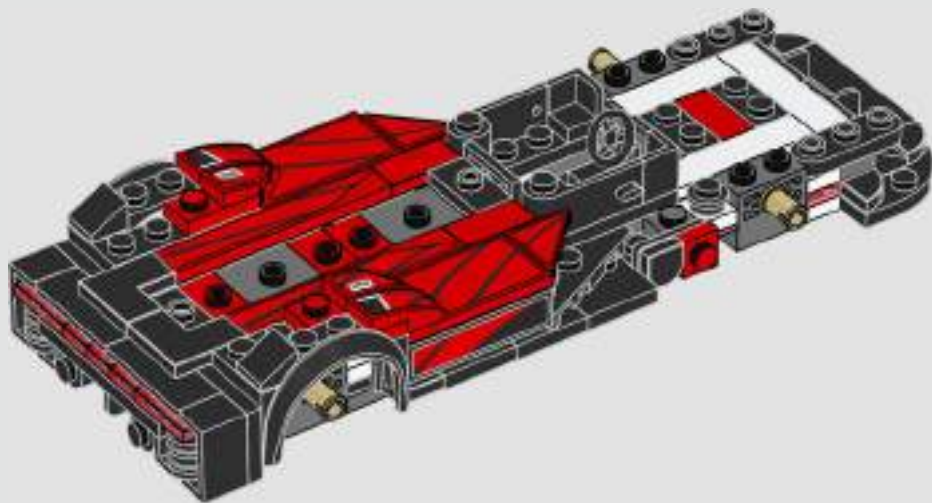



61

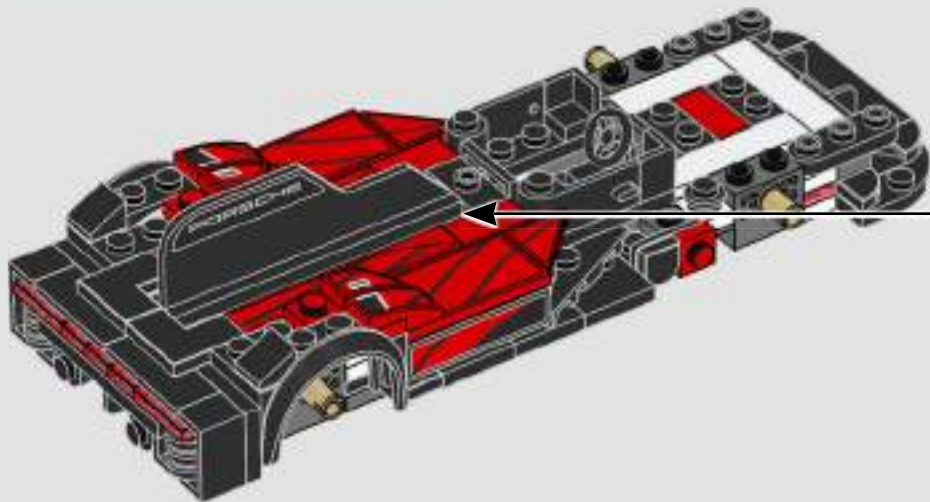
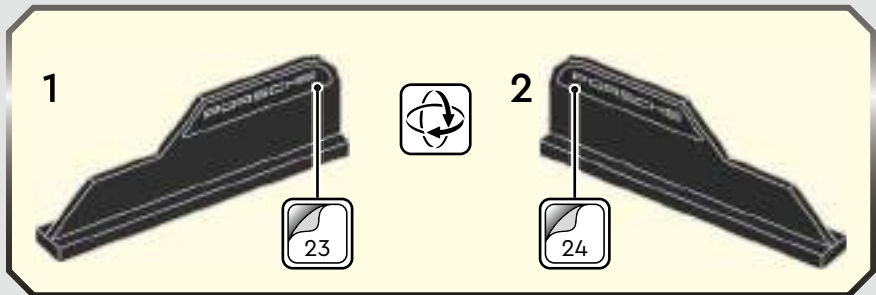



62

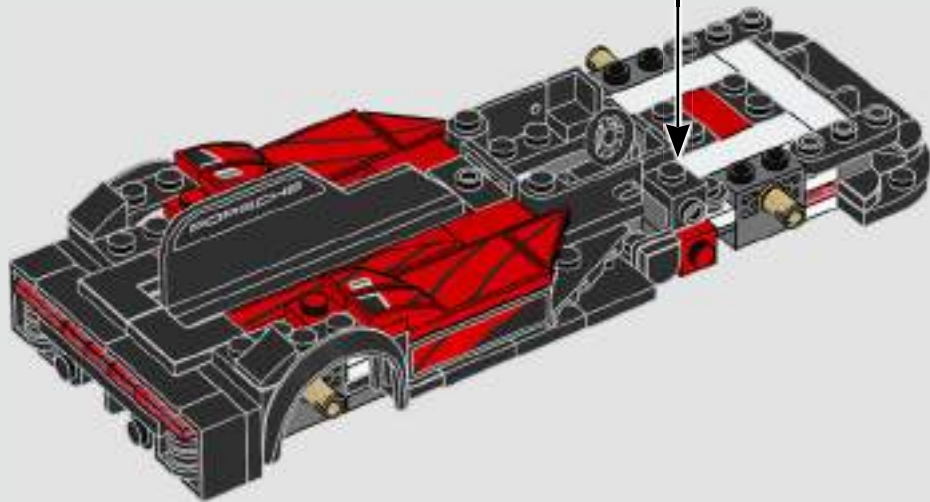



1x



1x

63

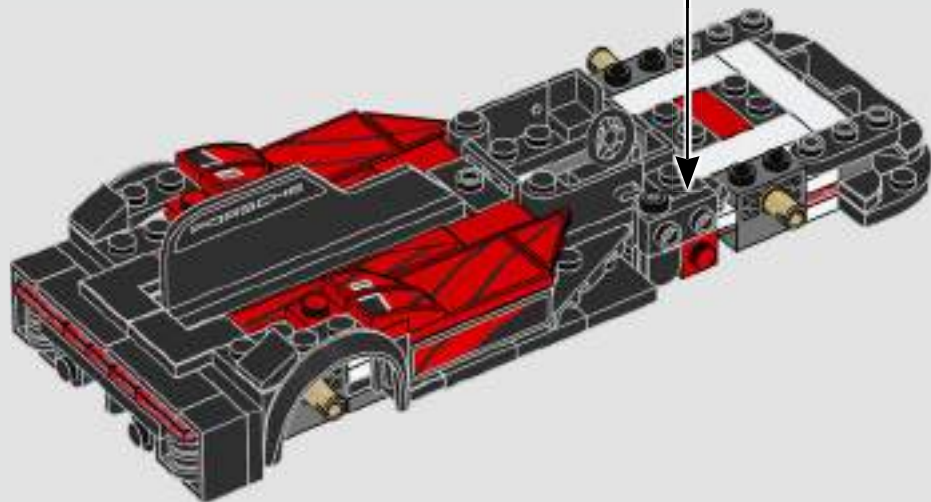



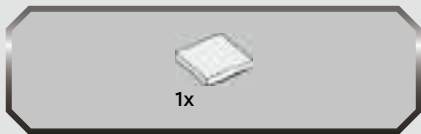

64

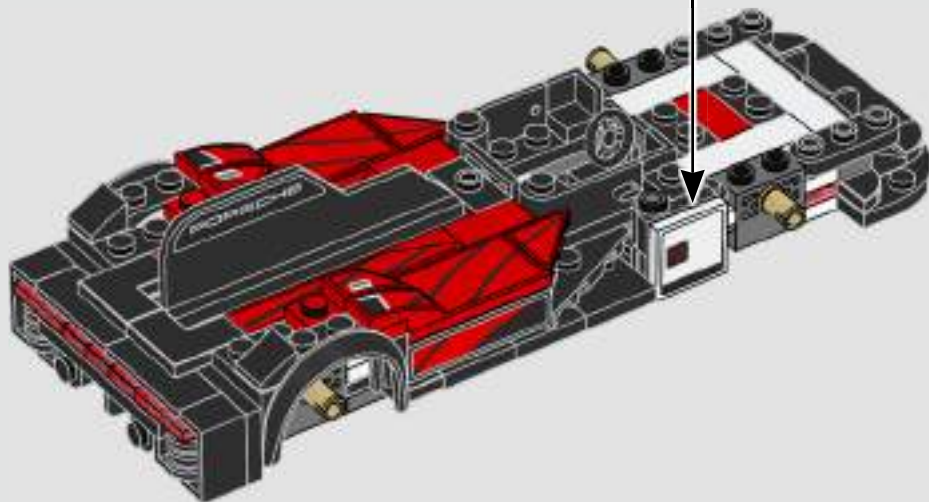



65

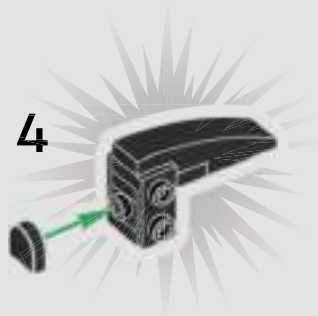

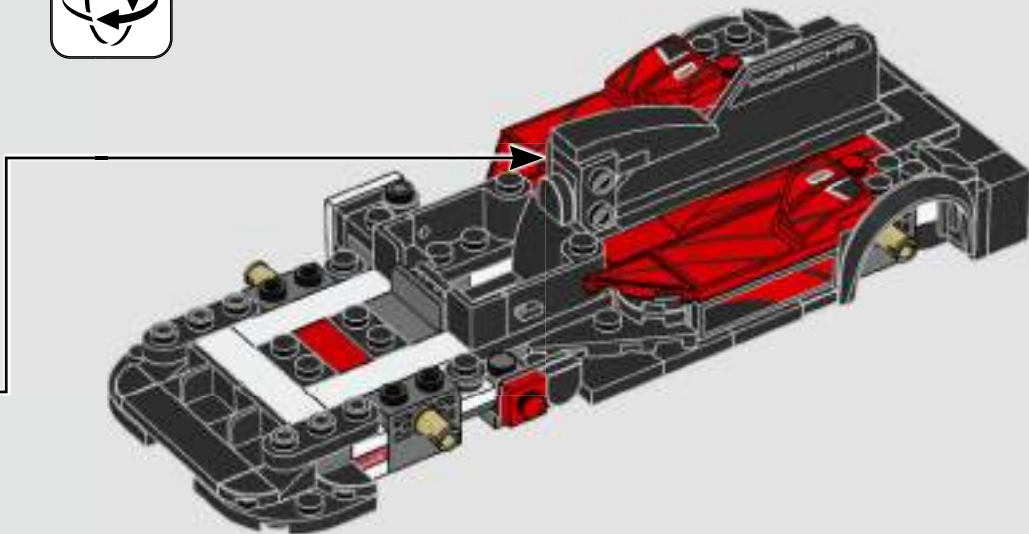



66

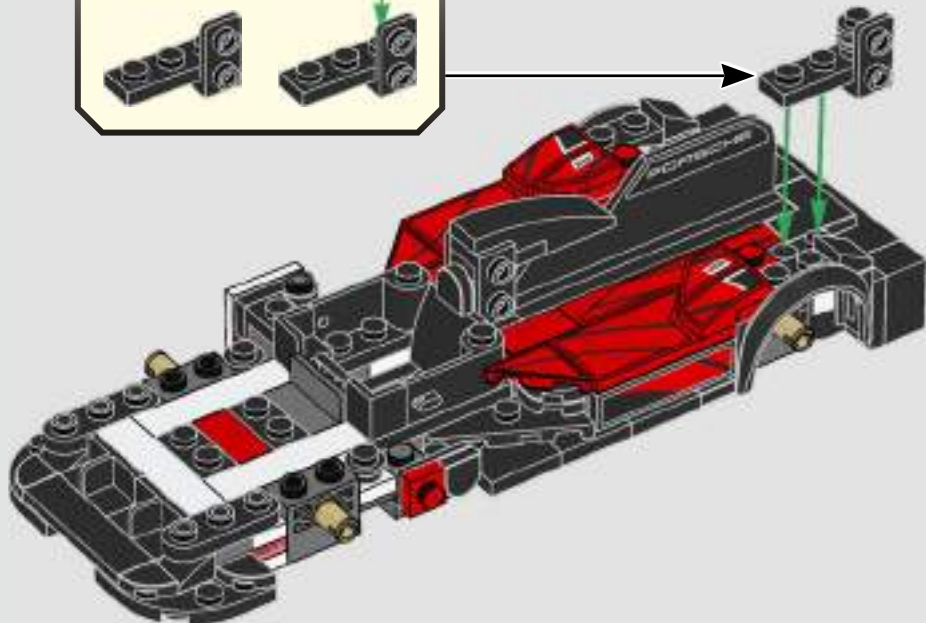
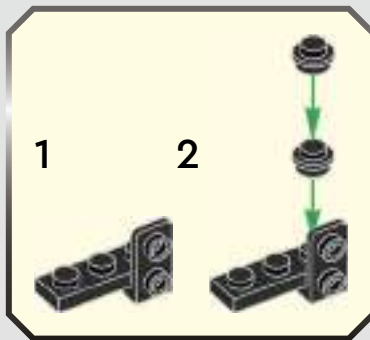

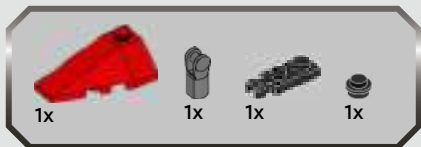

67

1



2



3

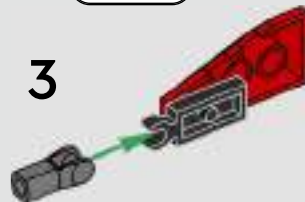

4



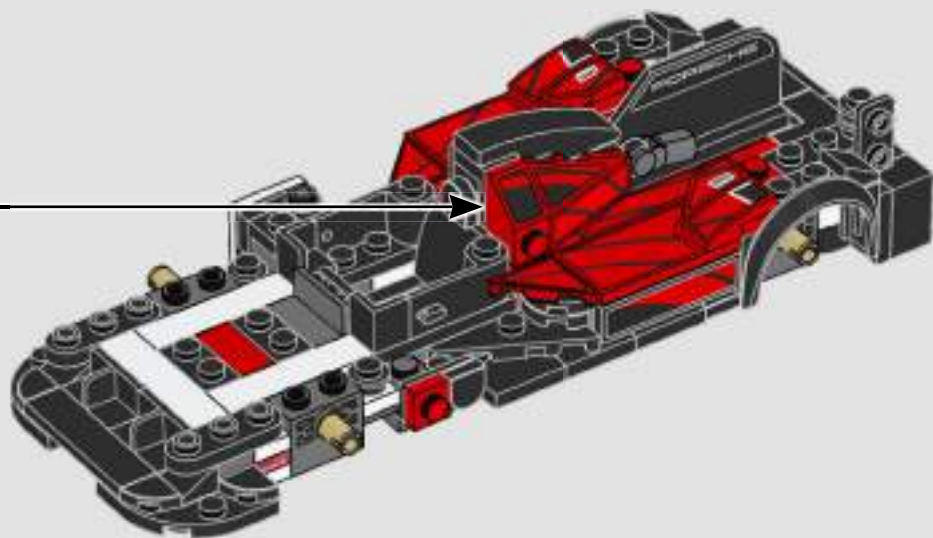



68

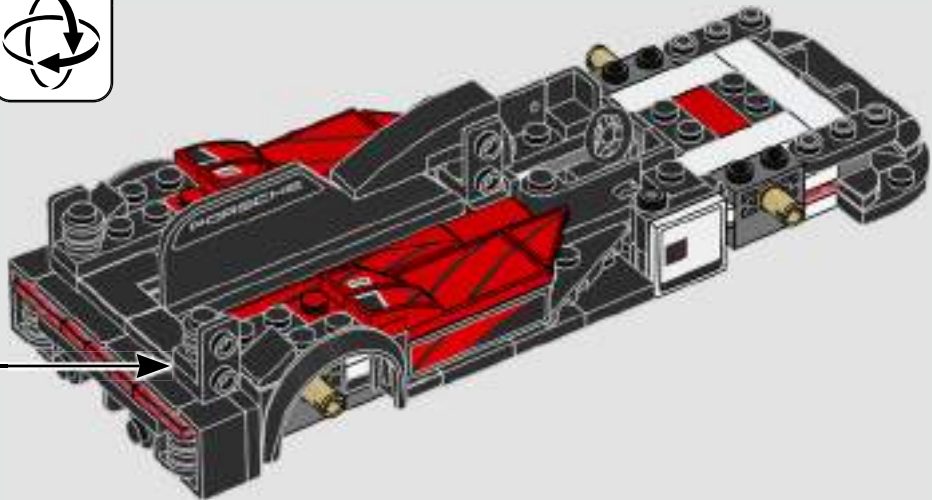
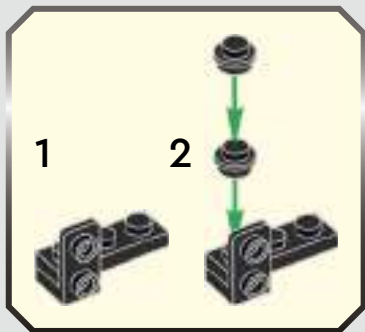



69

1



2



3



4





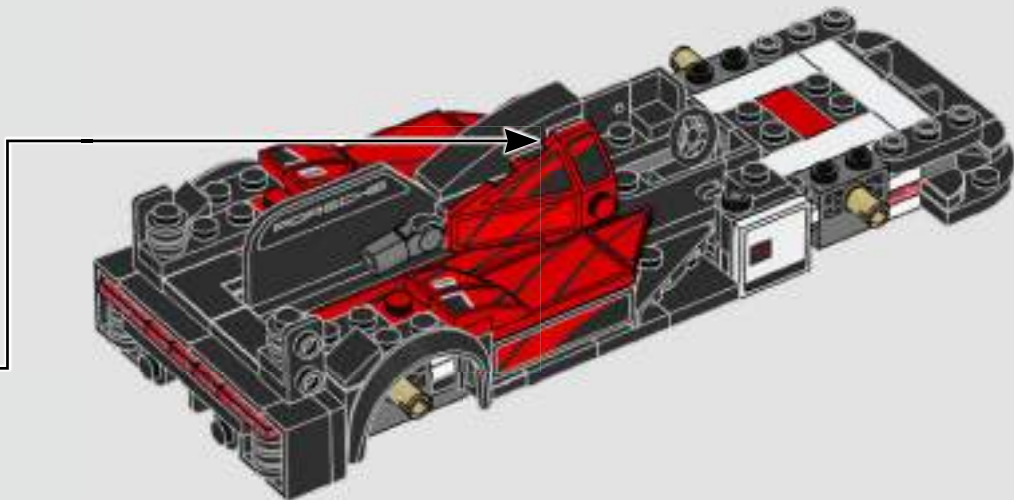



70

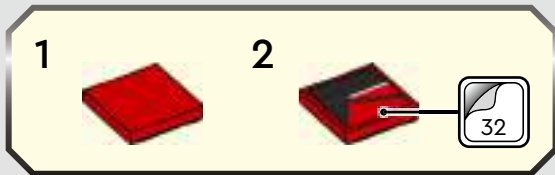

2



32

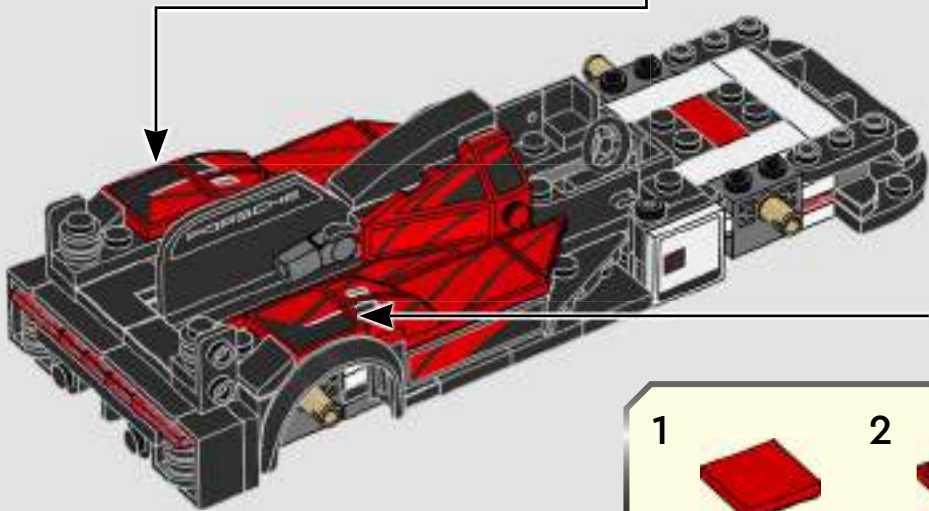

2



33



71

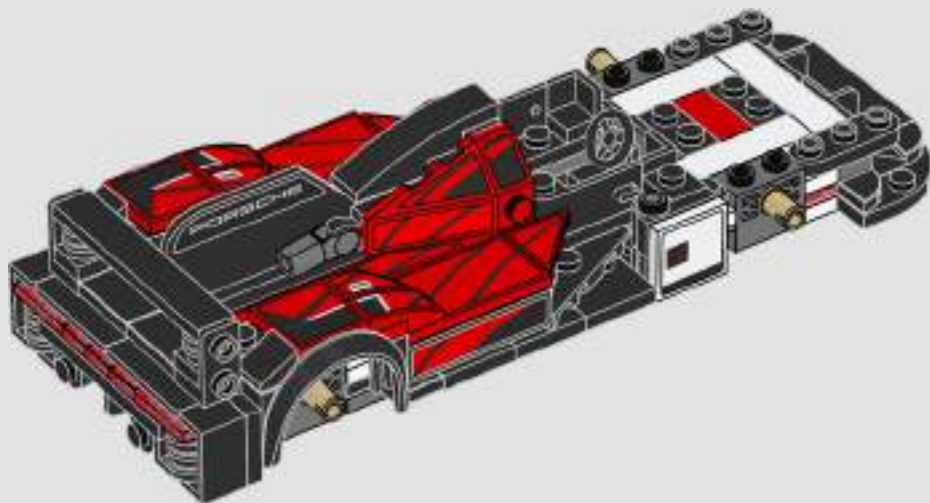



72

1



2



3

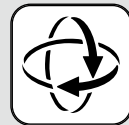

4



5

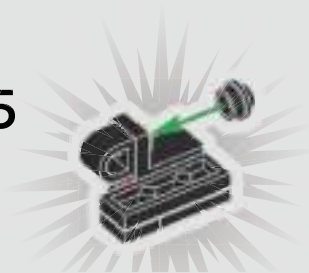

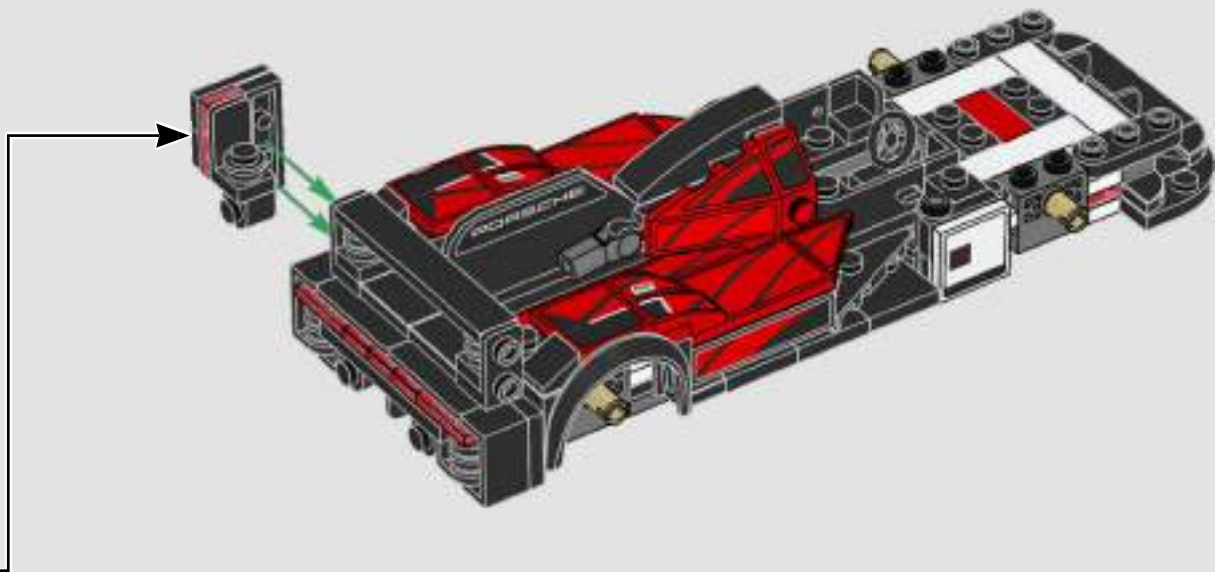



73

1



2



3

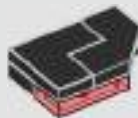

4



5

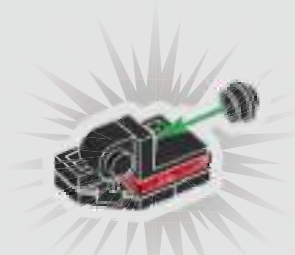

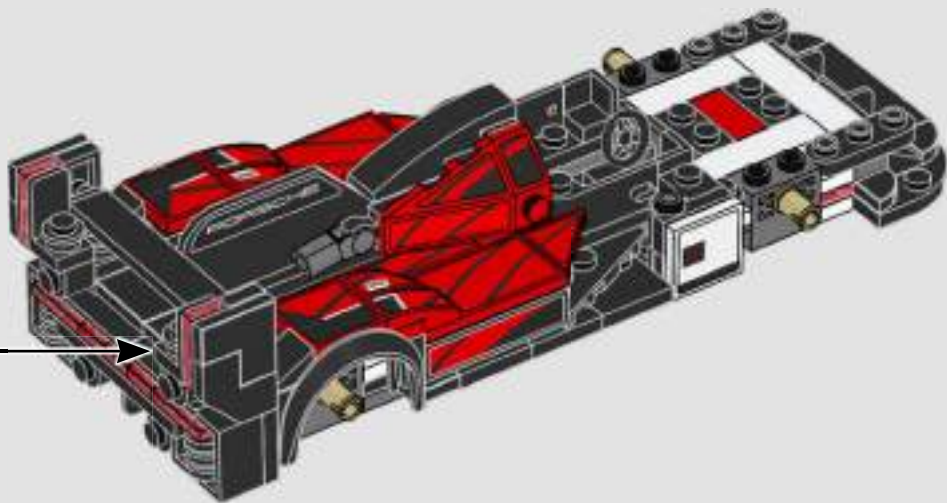



74

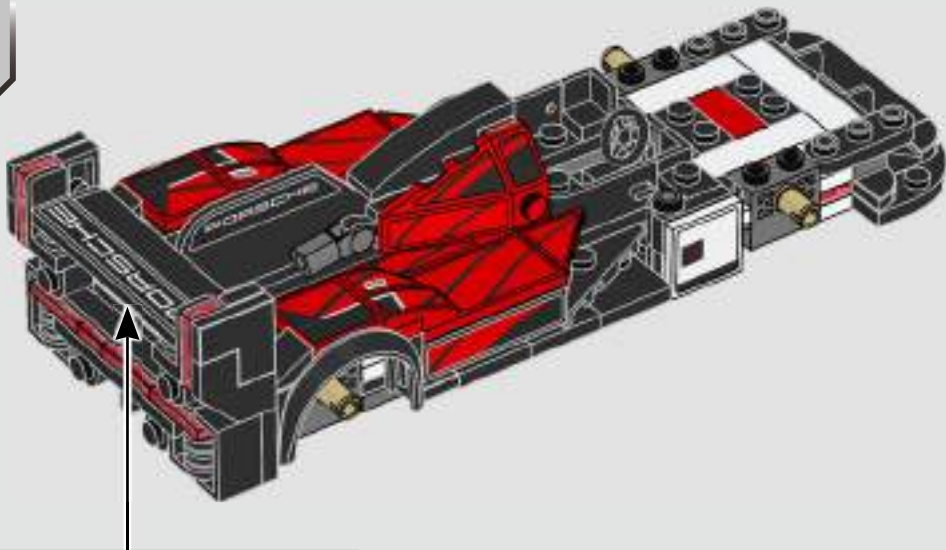



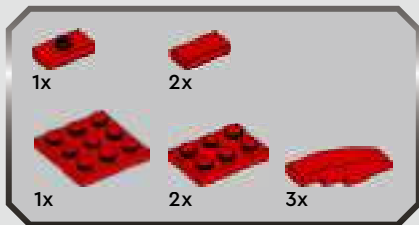

75

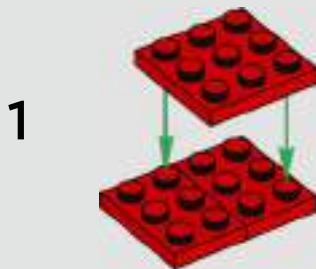

2



3

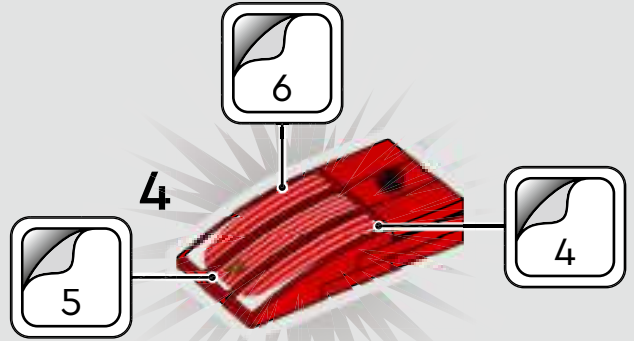

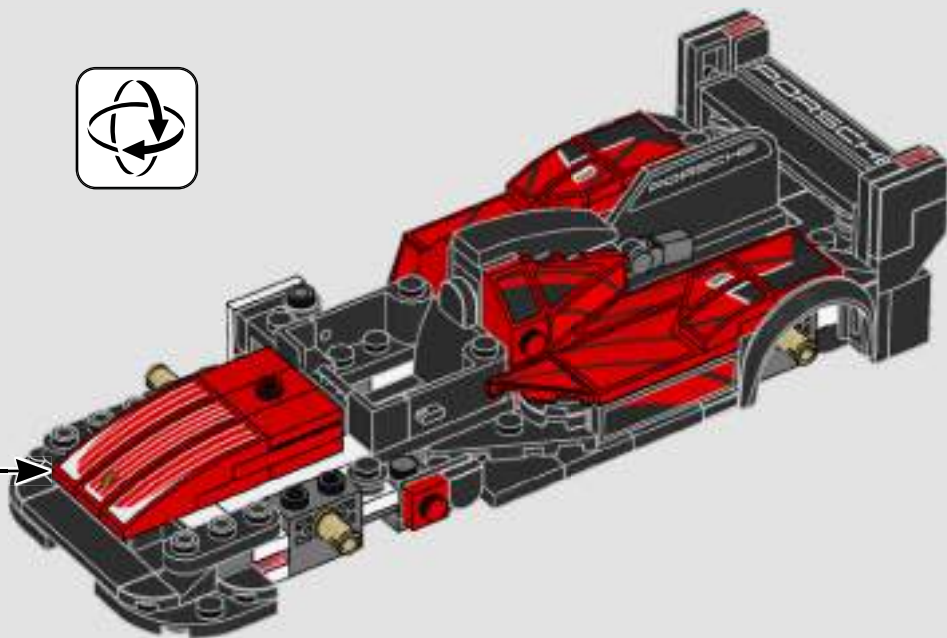



1x



1x

76

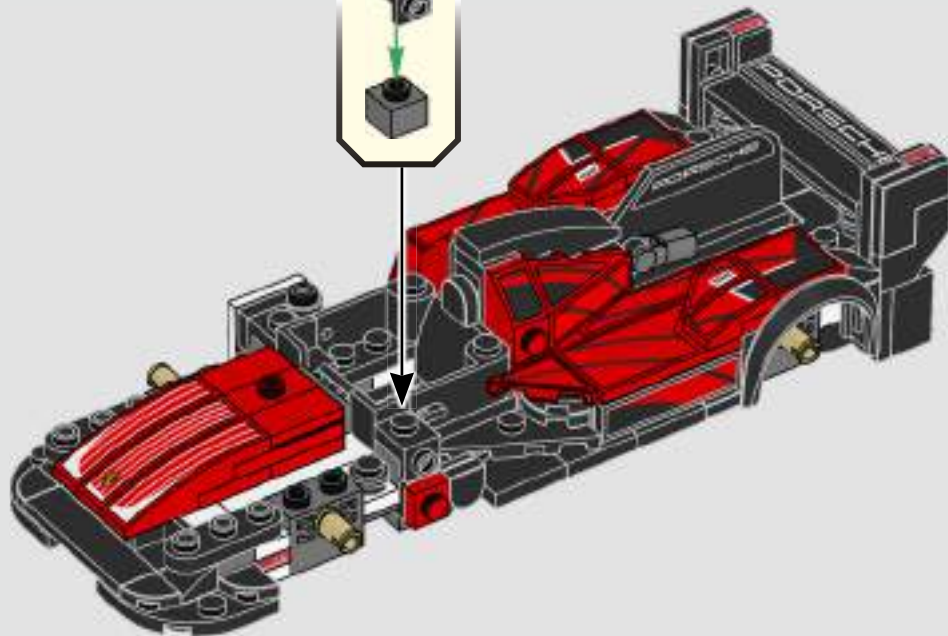

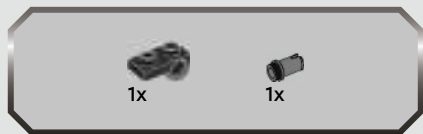

77

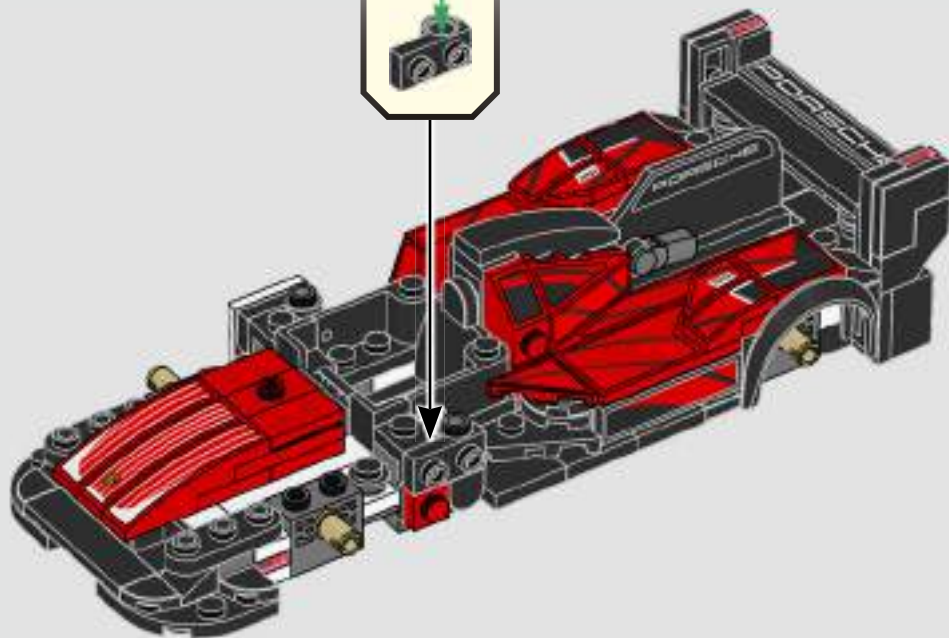

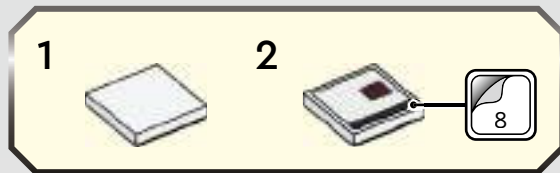
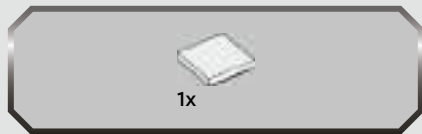

78

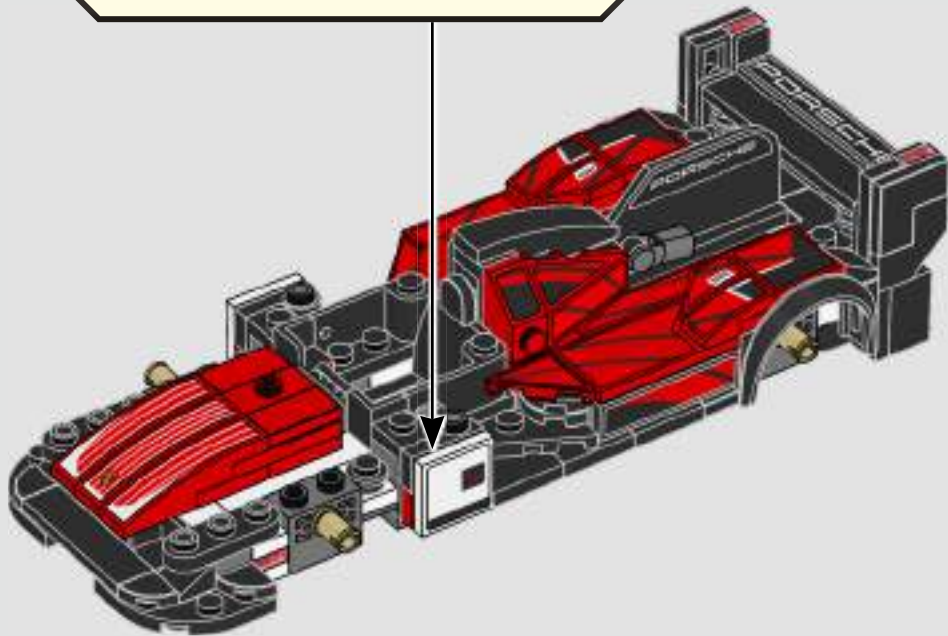



79

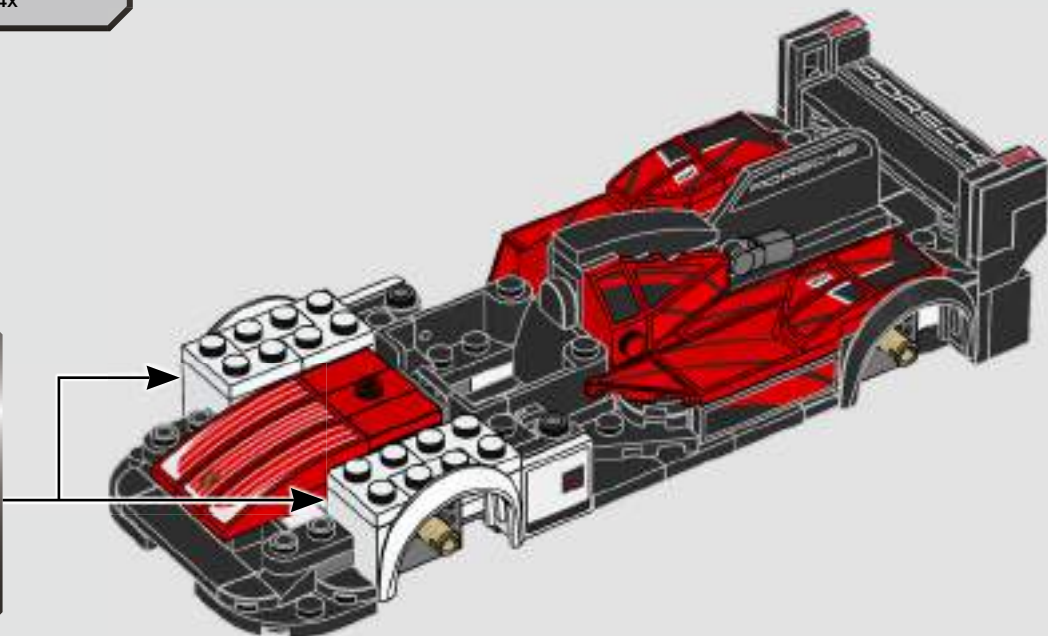
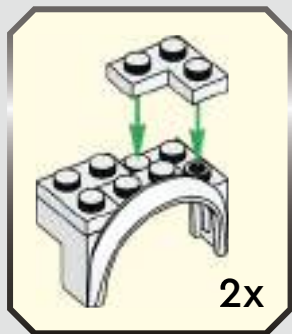

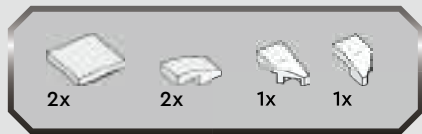

80

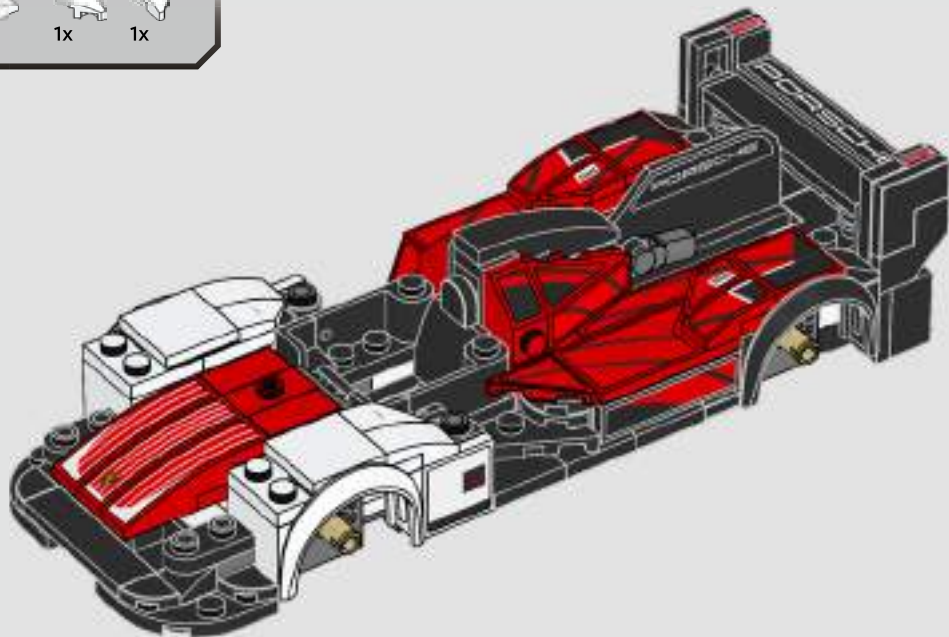



81

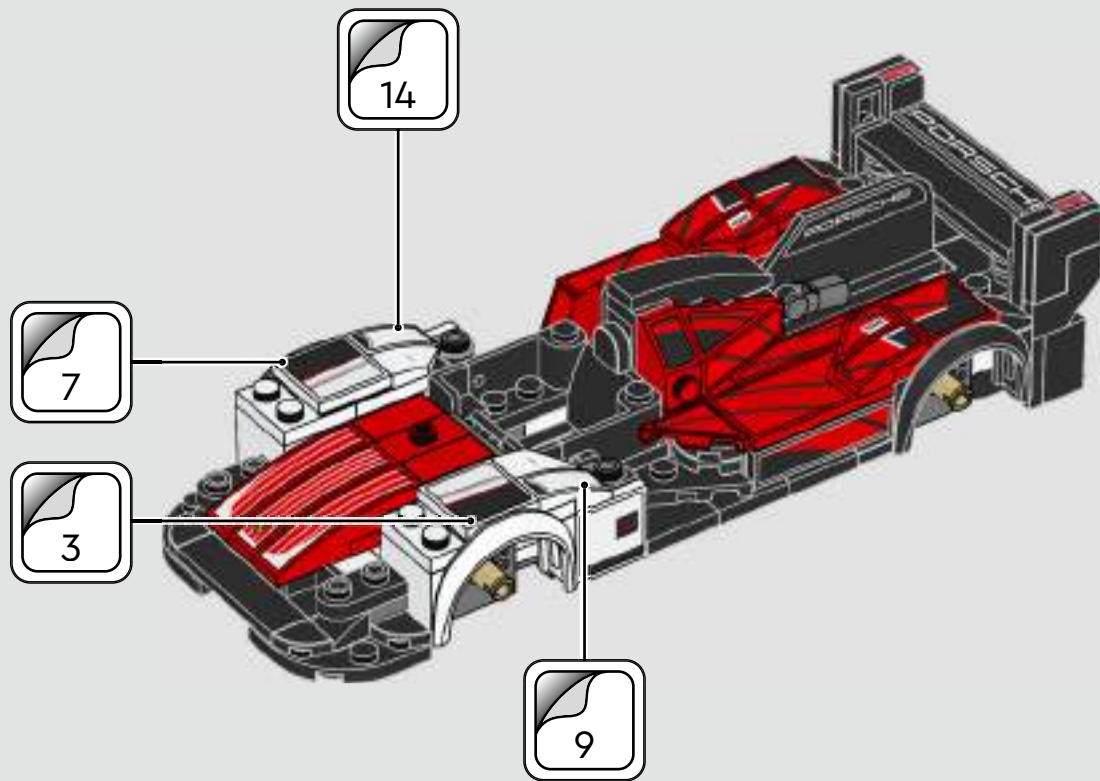



2x



2x

82

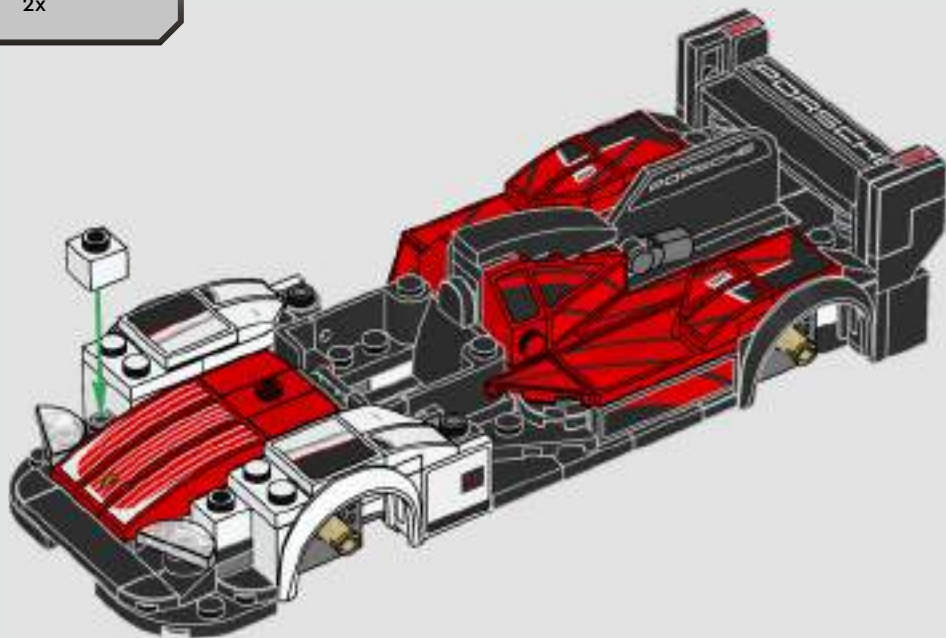

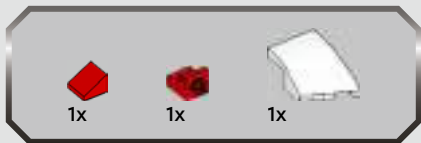

83

1



2

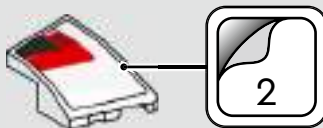

3

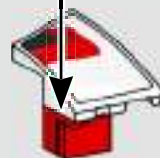
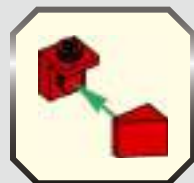

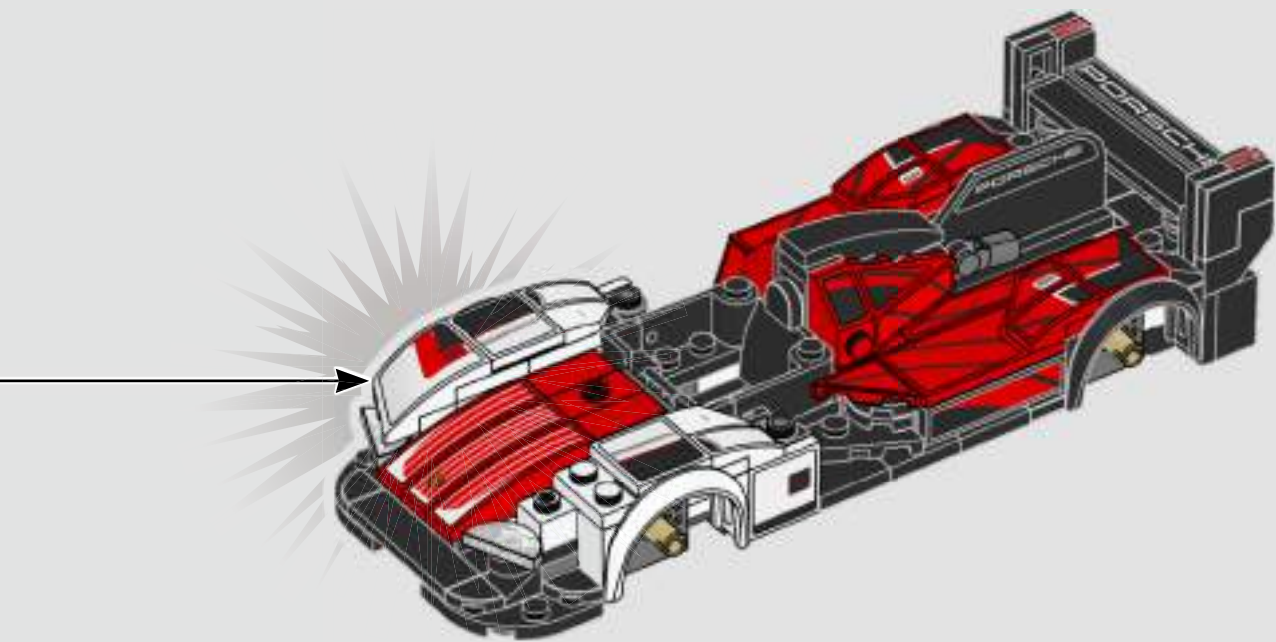



84

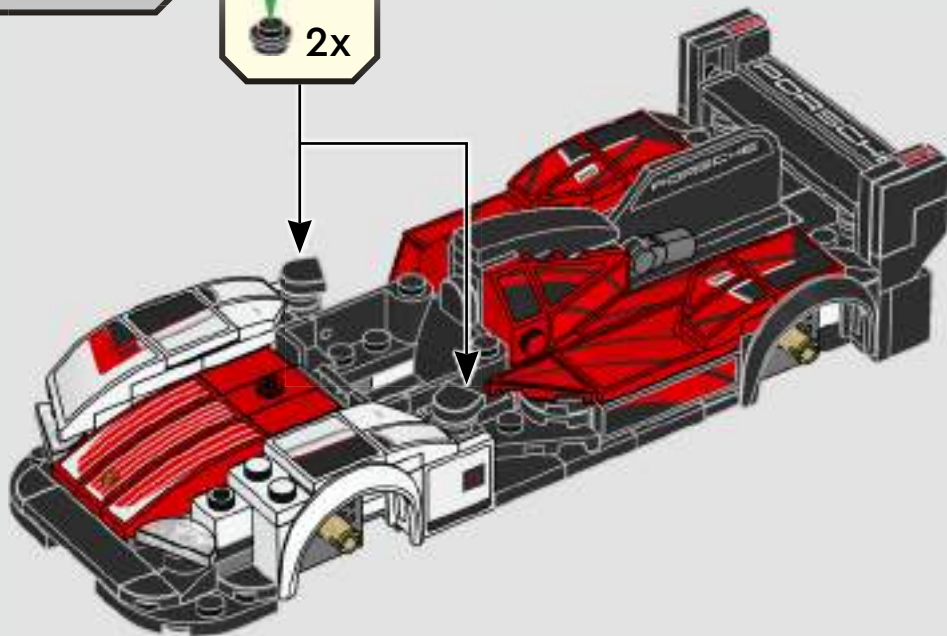

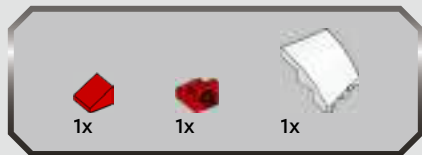

85

1



2

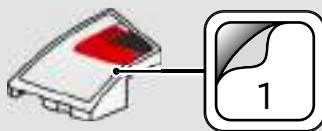

3

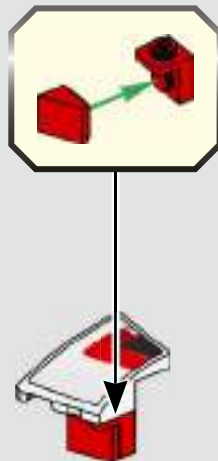

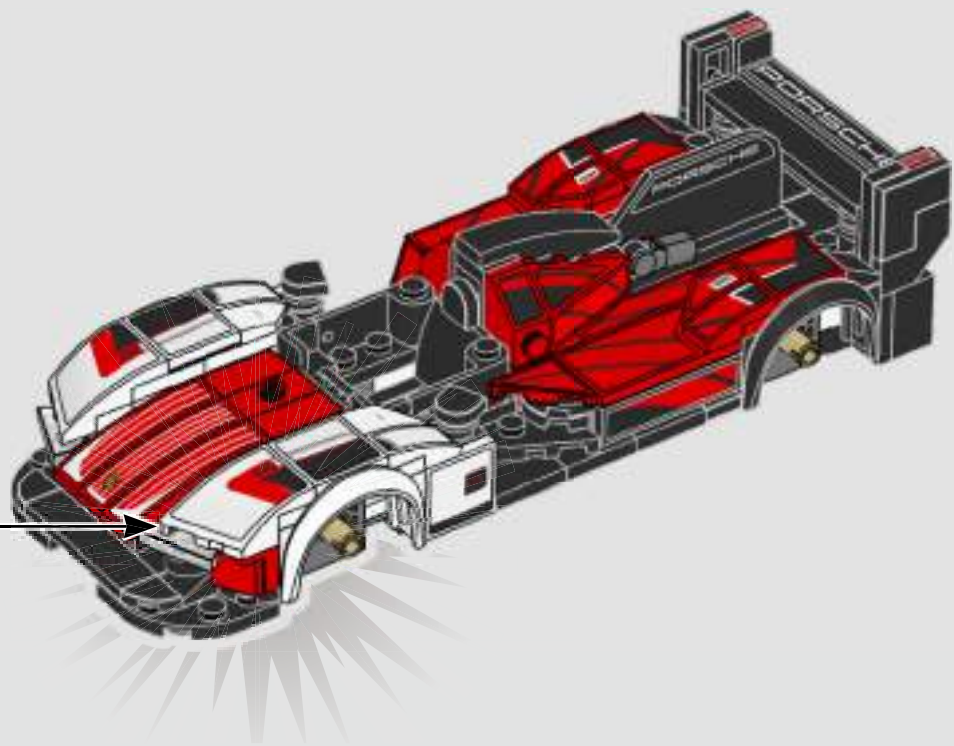



86

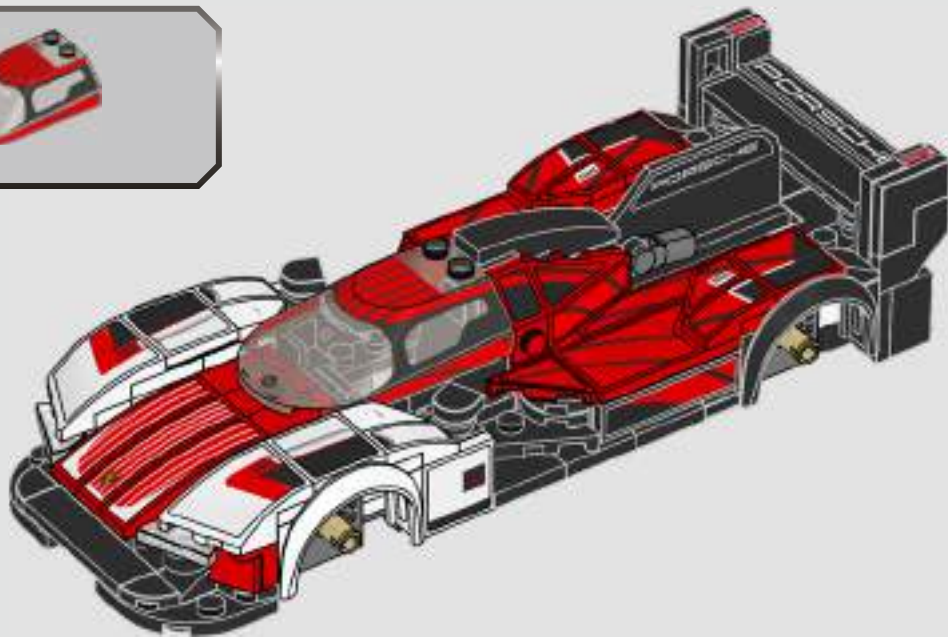





87

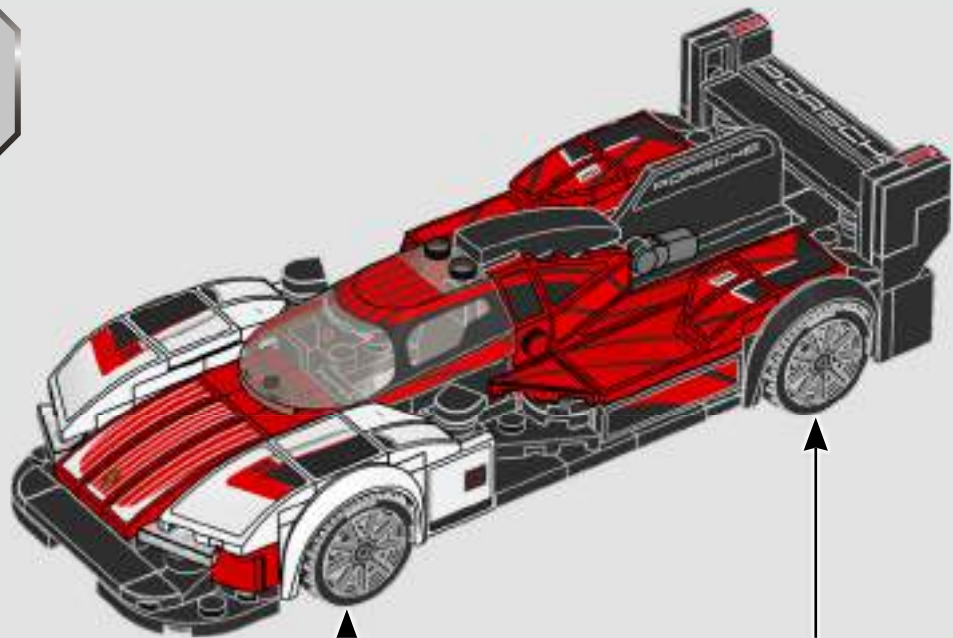

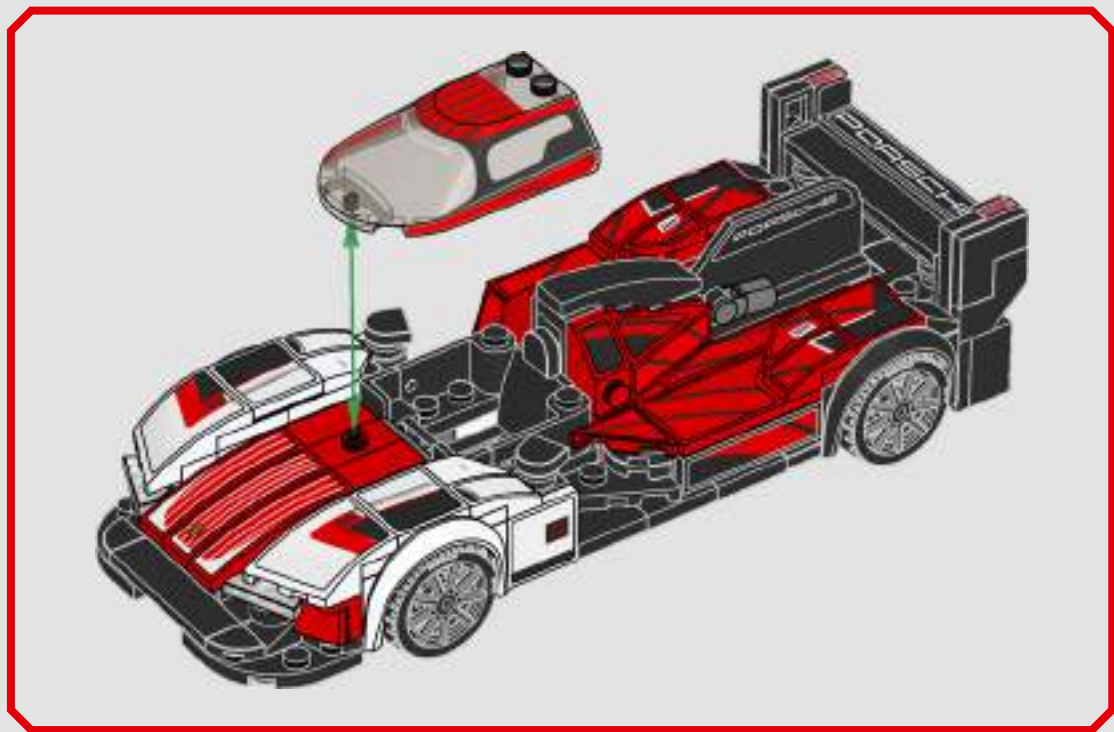

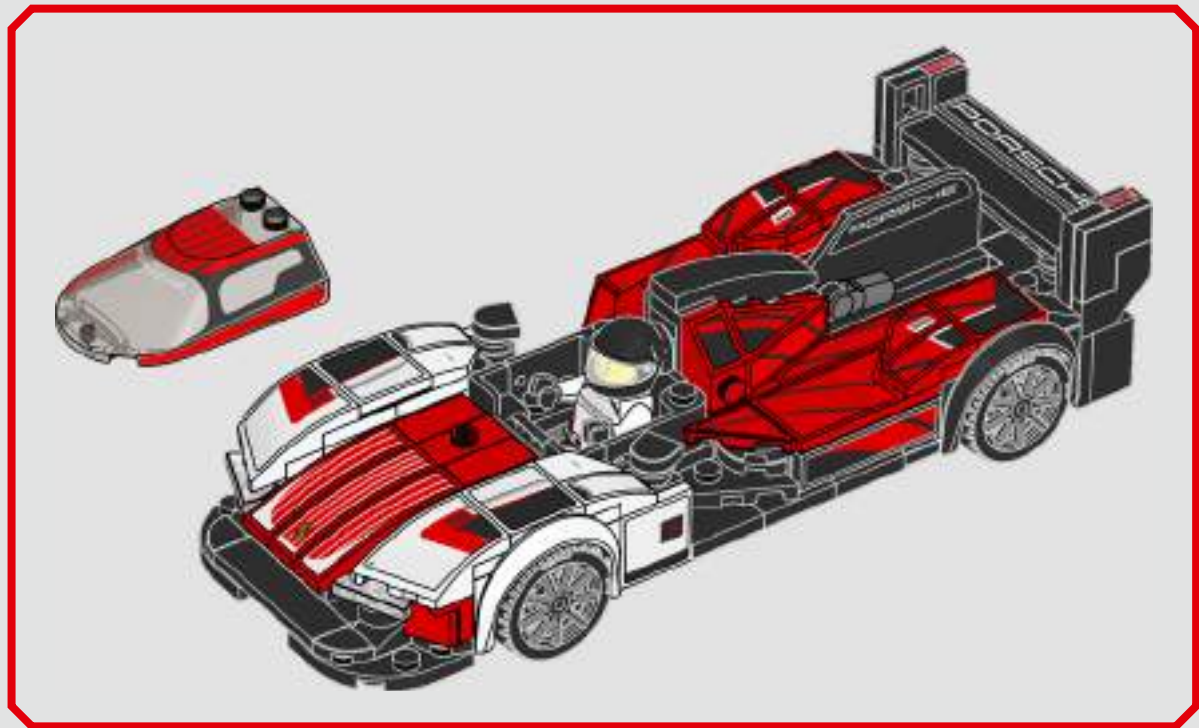

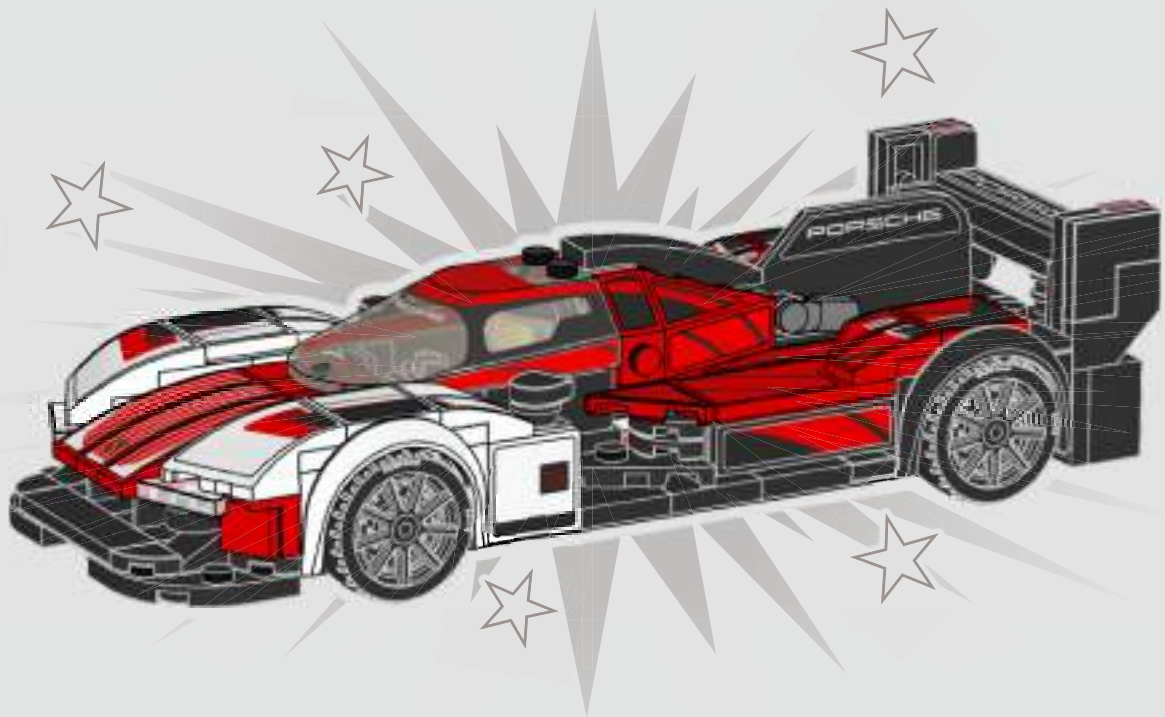



# SPEED CHAMPIONS



76918



76914

Produced under license of Ferrari S.p.A. The name FERRARI, the PRANCING HORSE device, all associated logos and distinctive designs are property of Ferrari S.p.A. The body designs of the Ferrari cars are protected as Ferrari S.p.A. property under design, trademark and trade dress regulations.



76915

The trademarks PAGANI and Pagani Automobili and Utopia are registered trademarks and used under license from HORACIO PAGANI S.P.A., Italy

Under license of Porsche AG.



76916

Nissan Motor Co., Ltd. trademarks, designs, copyrights and/or other intellectual property rights used under license.



































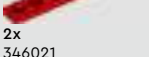





























Copyright © 24 Hours of Le Mans. « Le Mans », « 24 Hours of Le Mans » and the 24 Hours of Le Mans' logo are registered trademarks of the Automobile Club de l'Ouest and are used under license by the LEGO Group.



76917

Manufactured under license from McLaren Automotive Limited. The McLaren name and logo are registered trademarks of McLaren.

© Universal City Studios LLC. All Rights Reserved.

 2x 4558952	 10x 242001	 2x 6438923	 2x 6029946	 1x 6431121	 4x 6172383	 2x 6248496
 4x 6383985	 1x 6407402	 2x 6351892	 2x 6351892	 2x 4113858	 5x 6335317	 2x 6092585
 1x 6213880	 1x 6407402	 4x 4666579	 2x 306821	 2x 4113858	 2x 6299338	 1x 73081
 1x 6213881	 4x 306801	 2x 4504379	 2x 242021	 2x 346021	 1x 6380236	 3x 302326
 1x 6438739	 1x 6046979	 2x 302421	 3x 302221	 1x 6438740	 1x 6295295	 2x 6192309
 4x 302301	 1x 6443869	 1x 6177505	 2x 302121	 22x 614126	 1x 6295293	 2x 6020193
 2x 6034044	 1x 6407399	 2x 6249907	 3x 6045937	 5x 6256435	 4x 6438919	 1x 6024113
 4x 6018774	 3x 243101	 1x 6177507	 1x 6431123	 9x 6424674	 4x 4548180	 4x 6428168
	 5x 302001	 4x 6092565	 1x 6217123	 4x 4106347	 3x 6115086	 2x 6350725
		 5x 306921	 2x 4560179	 4x 4504382		



7x  
6192346



6x  
6133722



1x  
6053077



1x  
4298619



2x  
6166859



1x  
6024114



2x  
6382491



4x  
362326



4x  
6336858



1x  
400626



2x  
4227392



8x  
371026



3x  
243126



1x  
6037746



2x  
6443446



1x  
6350415



1x  
6039194



2x  
663626

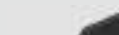

1x  
6438920



1x  
303426



1x  
4656764

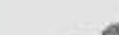

1x  
6336204



1x  
6244787



2x  
6443797



5x  
6254248



2x  
6251290



10x  
6240212



1x  
6408458



2x  
6397633



2x  
6395635



2x  
6388133



1x  
6146225



2x  
6215212



2x  
6126083



4x  
4210635



1x  
6343852



3x  
4211043



2x  
4211056



2x  
6287680



2x  
4210678



1x  
6368591



 [LEGO.com/service](https://www.lego.com/service)



YOU COULD  
**WIN**



Scan this QR code or go to  
**LEGO.COM/PRODUCTFEEDBACK** and give us  
your short feedback about this LEGO® set for  
a chance to win a cool LEGO prize.

Terms and Conditions apply\*

**DE: Du könntest GEWINNEN.** Es gelten die Teilnahmebedingungen\* **FR: Tu pourrais GAGNER.** Des conditions s'appliquent\* **IT: Potresti VINCERE tu.** Termini e condizioni sono applicabili\* **ES: Puedes GANAR.** Aplican términos y condiciones\* **PT: Poderá GANHAR.** Aplicam-se termos e condições\* **JA: プレゼント付き! 利用規約が適用されます\*** **ZH: 轻松获奖.** 条款和条件适用\* **KO: 상품의 주인이 되어보세요. 소정의 약관이 적용됩니다\*** **RU: Вы можете ВЫИГРАТЬ.** Действуют положения и условия\* **PL: Szansa na WYGRANĄ.** Obowiązują warunki korzystania\* **CS: Máte šanci VYHRÁT.** Platí všeobecné smluvní podmínky\* **SK: Máte šancu VYHRAŤ.** Platia všeobecné zmluvné podmienky\* **HU: TE IS NYERHETSZ.** Felhasználási feltételek érvényesek\* **RO: Ai putea CÂȘTIGA.** Se aplică termenii și condiții\* **BG: Можете да СПЕЧЕЛИТЕ.** Има определени правила и условия\* **LV: Tu vari LAIMĒT.** Ir spēkā noteikumi un nosacījumi.\* **ET: Sul on võimalus VÕITA.** Kehtivad tingimused\* **LT: Jūs galite LAIMĖTI.** Taikomos sąlygos\*

\*[LEGO.com/productfeedback-terms](https://www.lego.com/productfeedback-terms)

LEGO and the LEGO logo are trademarks of the LEGO Group. ©2023 The LEGO Group.

Under license of Porsche AG.

Copyright © 24 Hours of Le Mans. « Le Mans », « 24 Hours of Le Mans » and the 24 Hours of Le Mans' logo are registered trademarks of the Automobile Club de l'Ouest and are used under license by the LEGO Group.

6500724