



# CITY

60366



# 1



**WARNING: CHOKING HAZARD.**  
Toy contains small parts and a small ball.  
Not for children under 3 years.



### **Get excited about our new packaging!**

We're switching from plastic to paper-based packaging. That's why you might find a mix of paper and plastic in our boxes!

### **Nos nouveaux emballages vous emballeront !**

Nous passons des emballages en plastique aux emballages à base de papier. C'est pourquoi vous pourriez trouver un mélange de papier et de plastique dans nos boîtes !

### **¡Te presentamos nuestros nuevos empaques!**

Estamos sustituyendo las bolsas de plástico por bolsas con base de papel. ¡Por eso, puedes encontrar una mezcla de papel y de plástico en nuestras cajas!

**[LEGO.com/sustainable-packaging](https://www.lego.com/sustainable-packaging)**



# BUILDER



Apple and the Apple logo are trademarks of Apple Inc., registered in the U.S. and other countries and regions. App Store is a service mark of Apple Inc. Google Play and the Google Play logo are trademarks of Google LLC. Tencent and the Tencent logo are trademarks of Tencent Inc.

Q [LEGO.com/devicecheck](https://www.lego.com/devicecheck)

EN Ask parents' permission before going online | DE Eltern um Erlaubnis bitten, bevor du online gehst | FR Demande l'autorisation d'un parent avant d'aller en ligne | IT Chiedi il permesso ai tuoi genitori prima di andare online | ES Pídeles permiso a tus papás antes de conectarte a Internet | PT pede autorização aos pais antes de acederes online | ZH 上网前应先征得父母的同意 | PL Poproś rodziców o zgodę, zanim wejdziesz do Internetu | CS Než půjdeš na internet, požádej rodiče o svolení | SK Skôr než půjdeš na internet, vypýtaj si povolenie od rodičov | HU Kérj szülői engedélyt, mielőtt online csatlakoznál! | RO Cere permisiunea părinților înainte de a te conecta online | BG Поискайте разрешение от родител, преди да влезете онлайн | LV Pirms došanās tiešsaistē palūdz atļauju vecākiem | ET Enne Interneti kasutamist küsi vanematelt luba | LT Prieš prisijungdami prie interneto, atsi klauskite tėvų

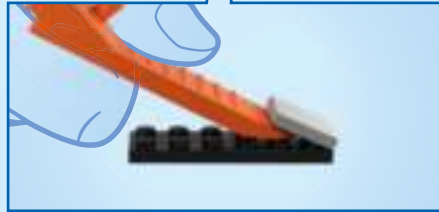
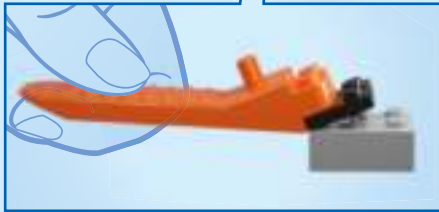
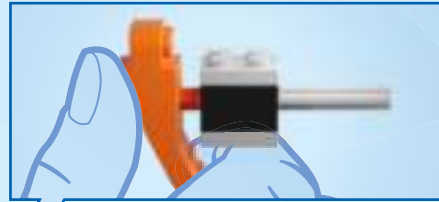

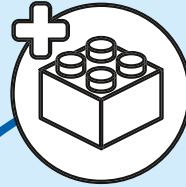
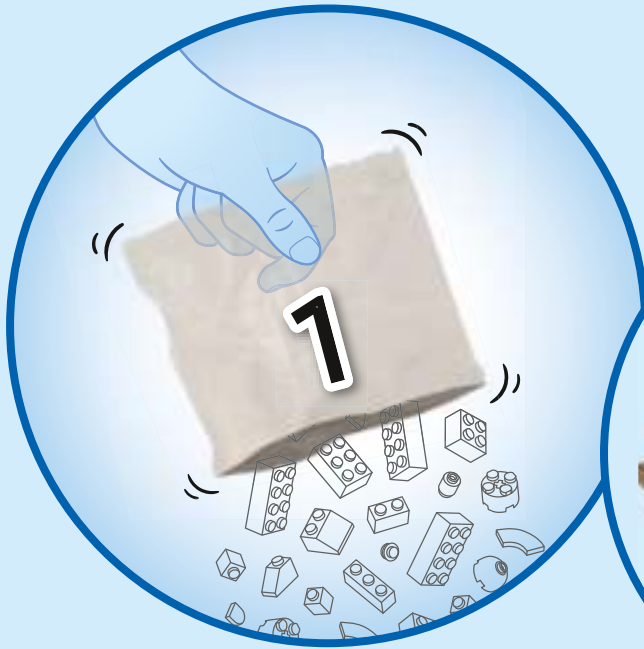

1x

 **AVERTISSEMENT : RISQUE D'ÉTOUFFEMENT.**  
Le jouet contient des petites pièces ainsi qu'une petite boule.  
Il ne convient pas aux enfants de moins de 3 ans.

 **ADVERTENCIA: PELIGRO DE ASFIXIA.**  
Juguete que contiene partes pequeñas y una pelota pequeña.  
No recomendado para niños menores de 3 años.



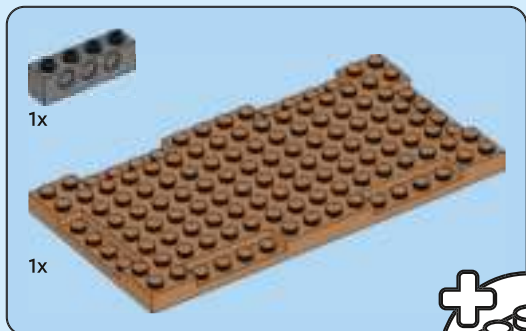

1

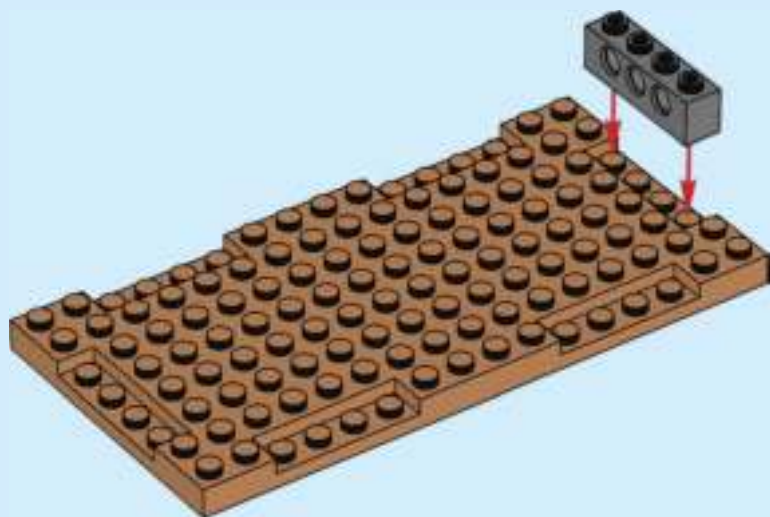
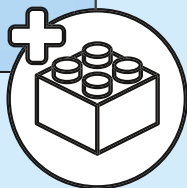



2x

2

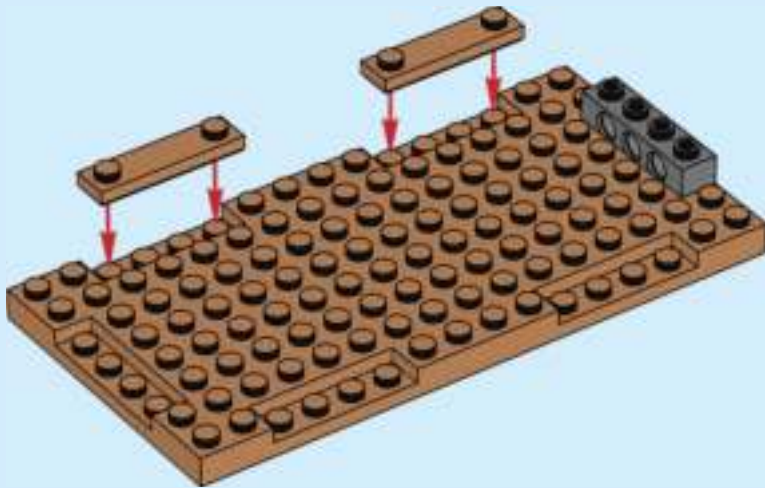





3

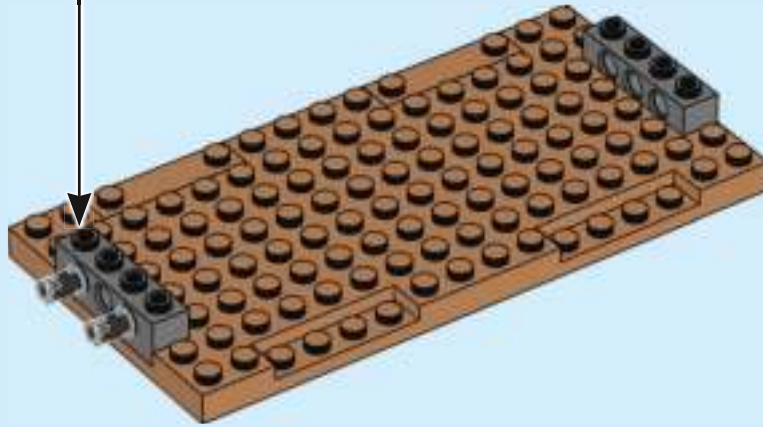
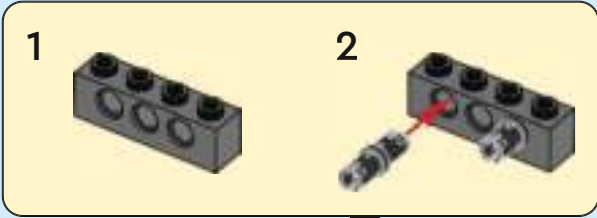



2x



2x

4

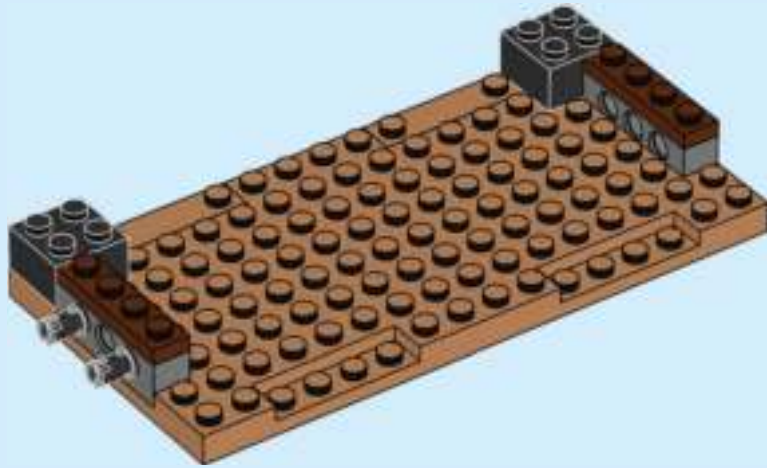



4x

5

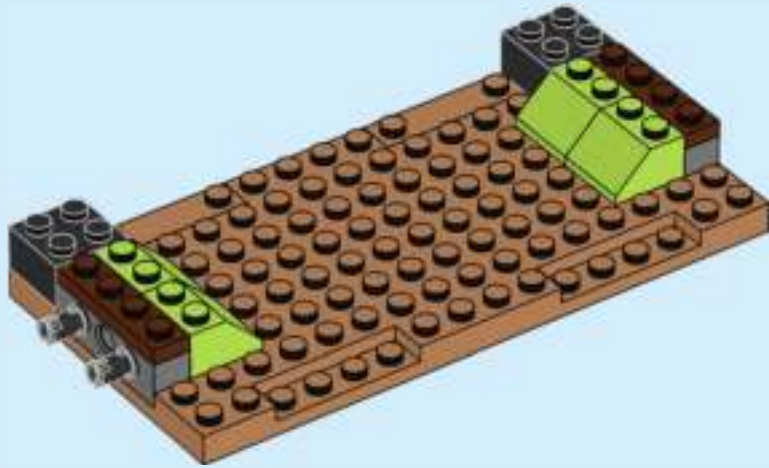



2x

6

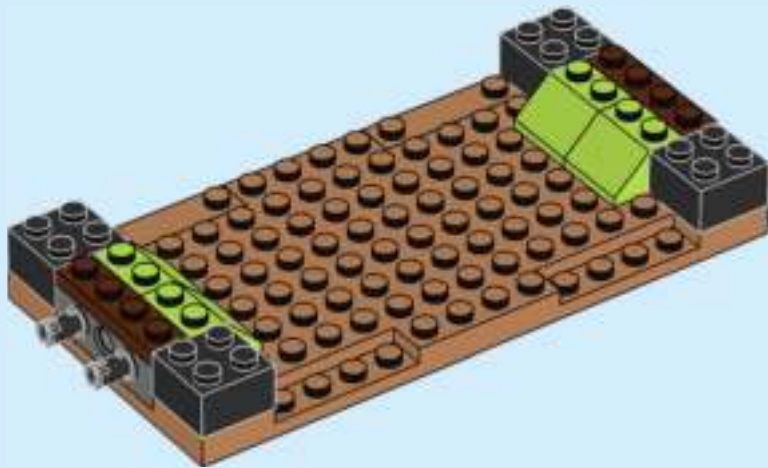

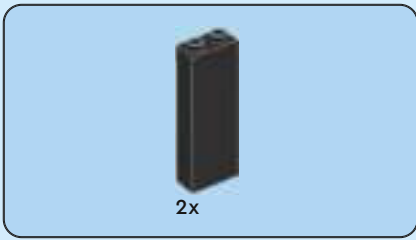

7

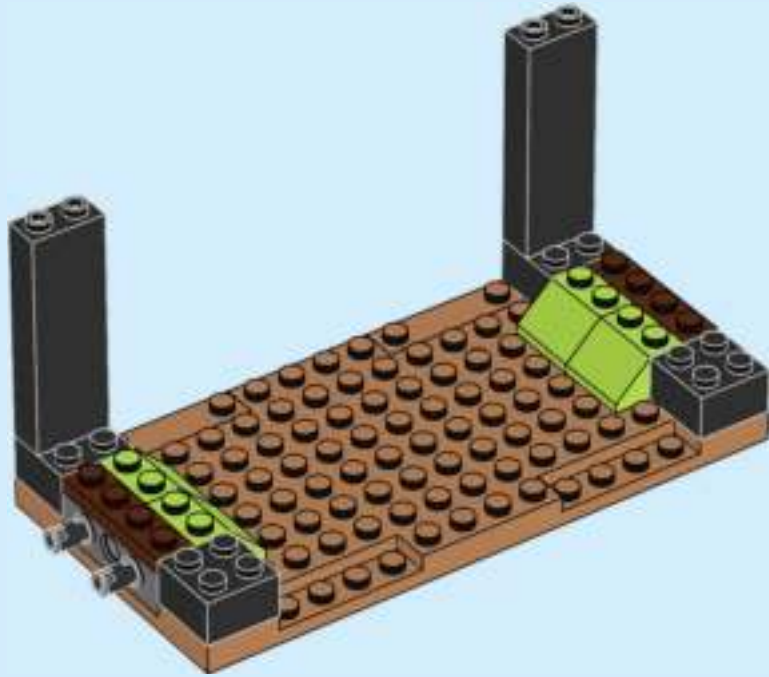



8

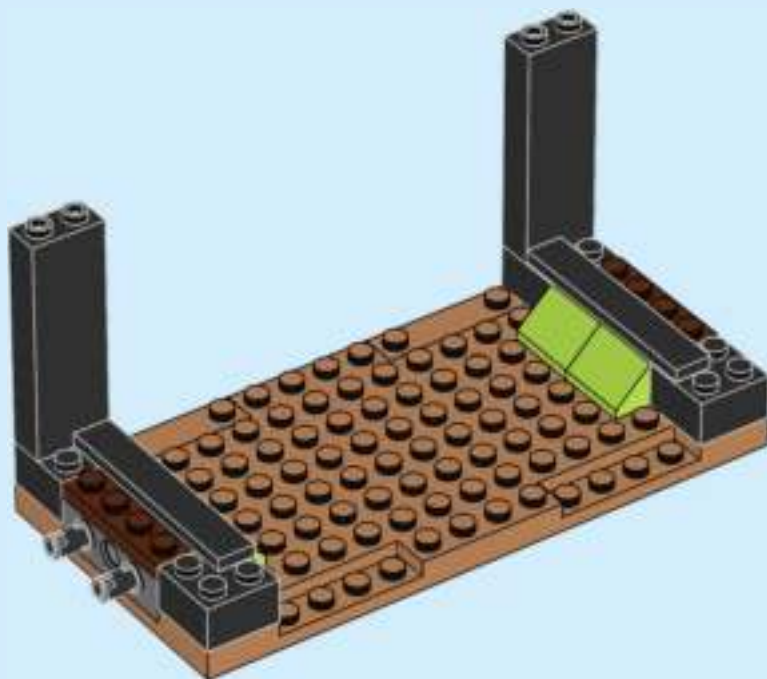

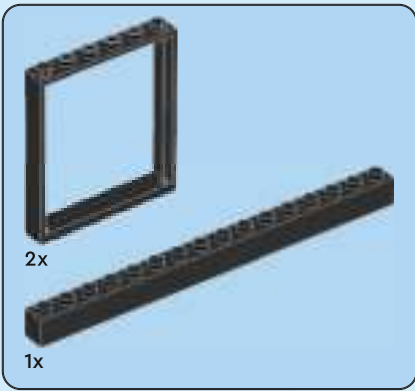

9

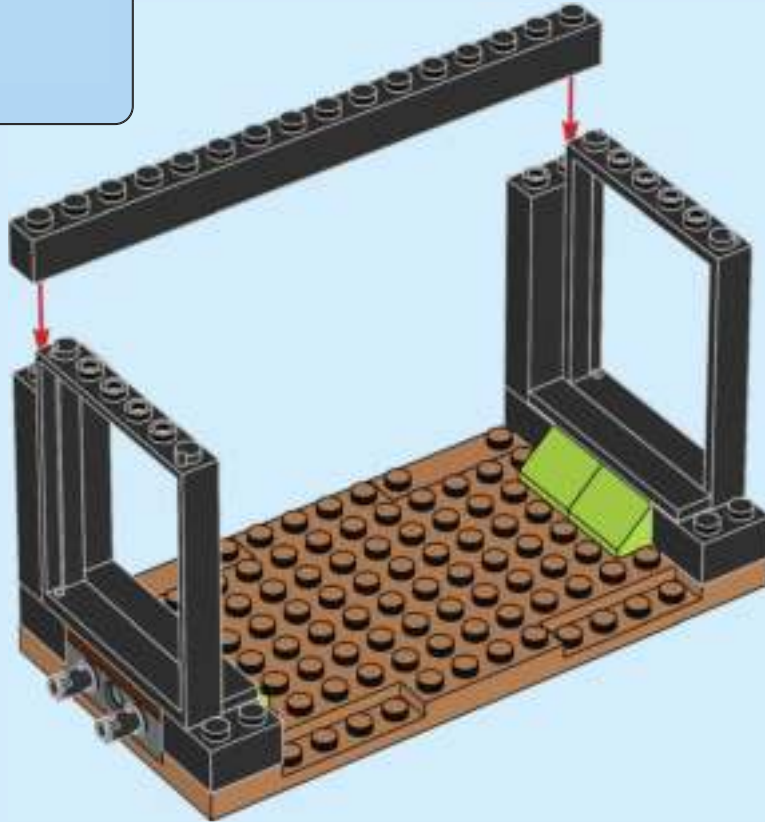



2x

10

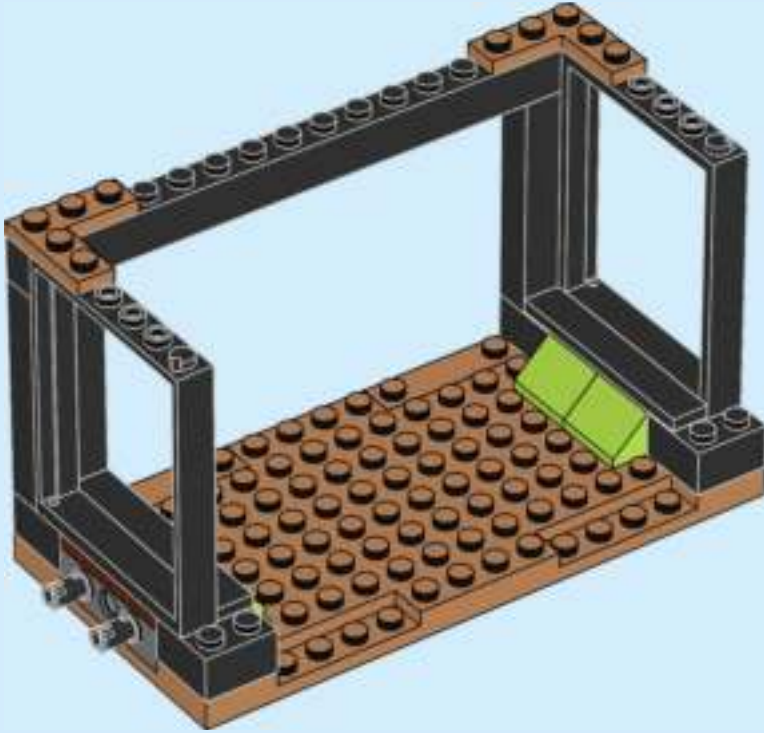



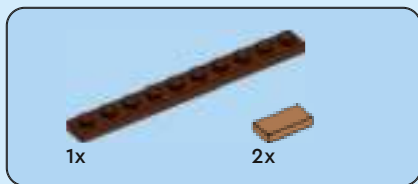

11

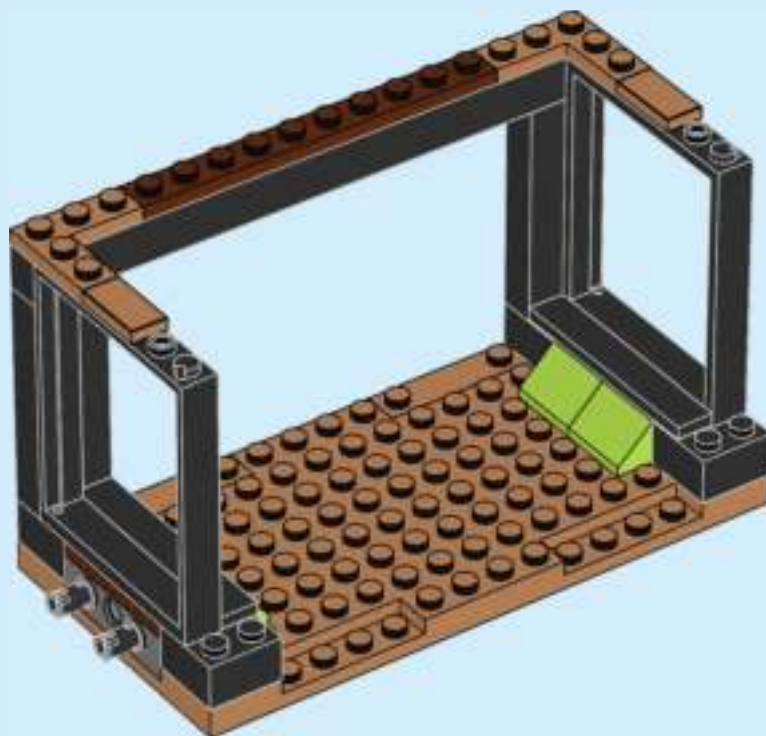

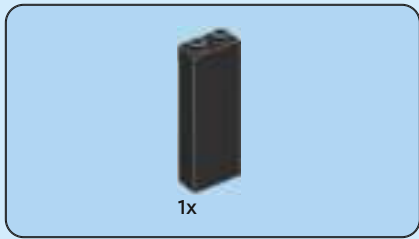

12

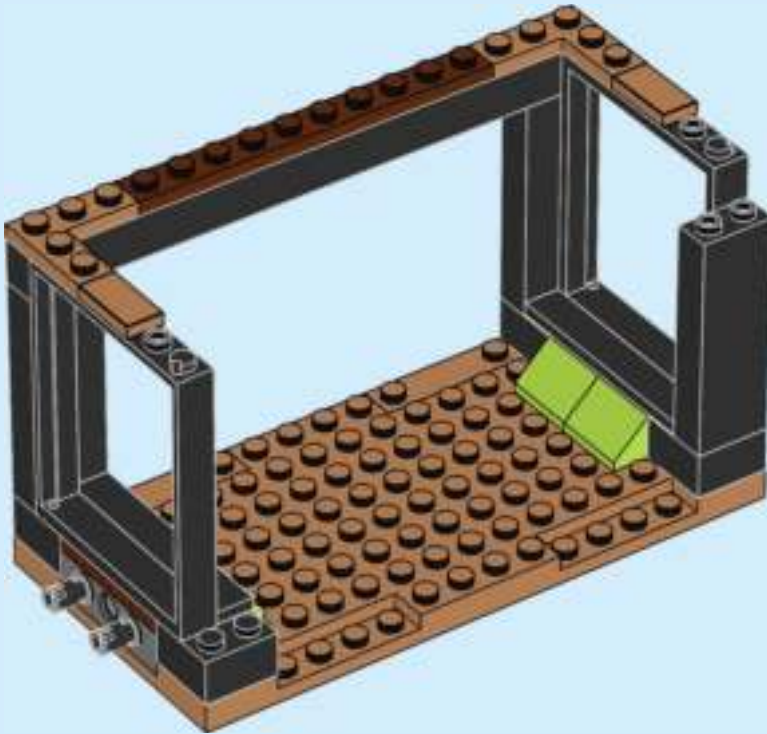



1x

13



2x

14





15



16



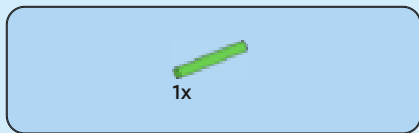

17



18





1x

19



1x

20



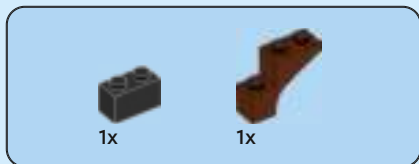

21



22





1x

23



1x

24





25

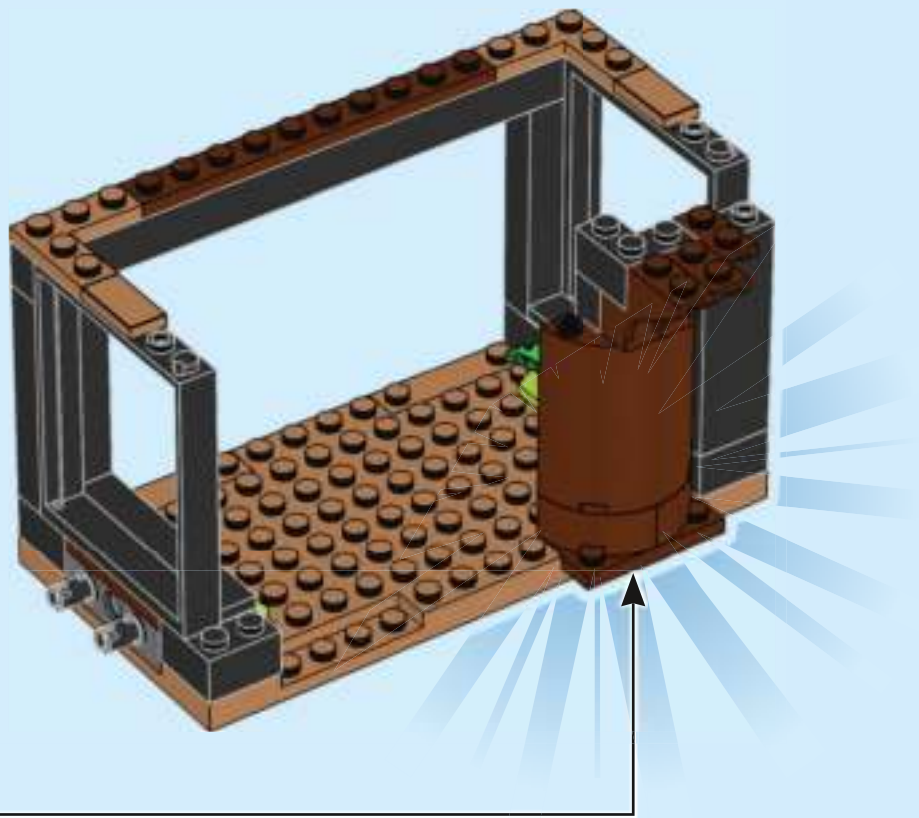



1x

26

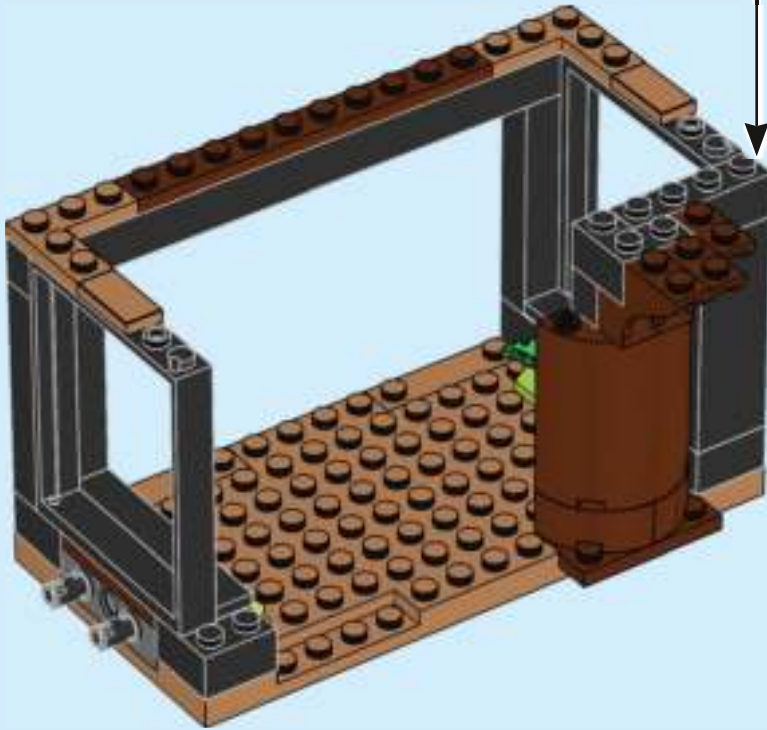
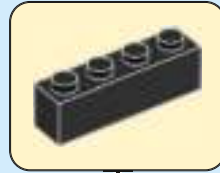

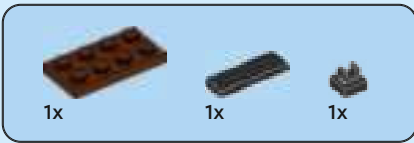

27

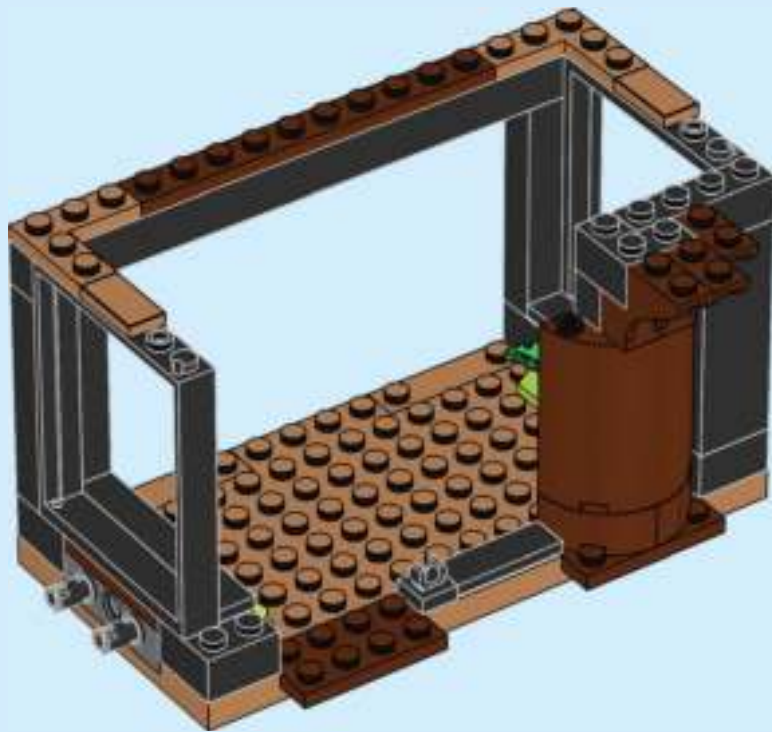

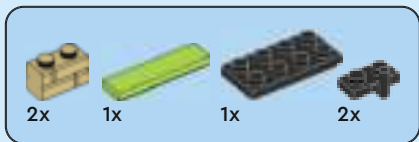

28

1



2

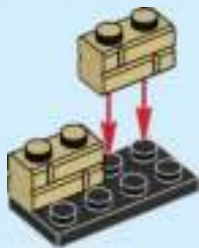

3

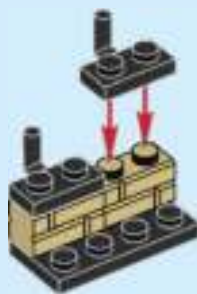

4

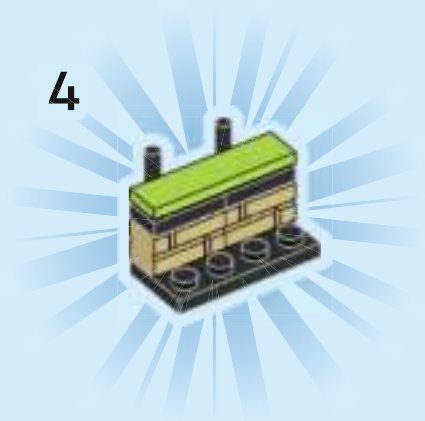

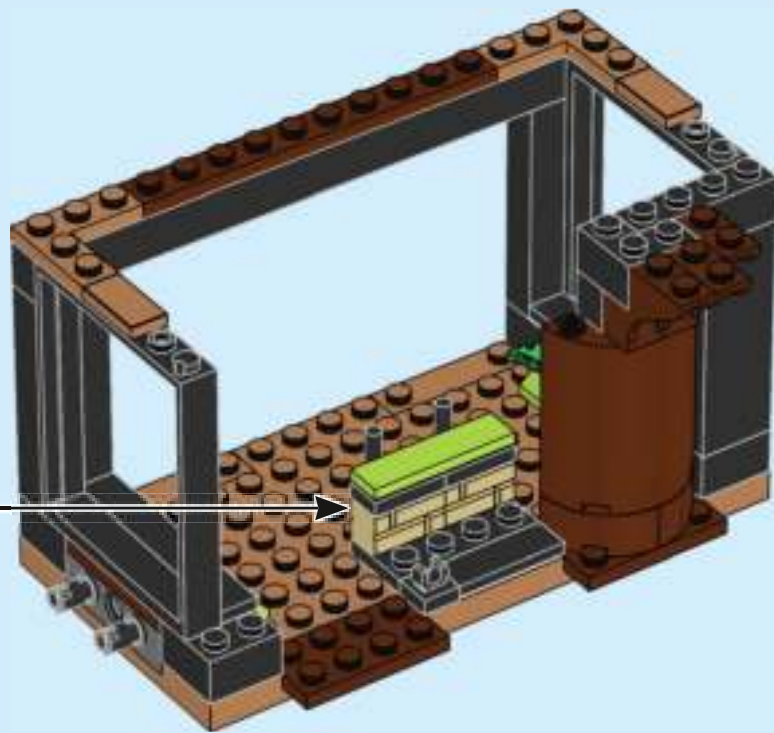

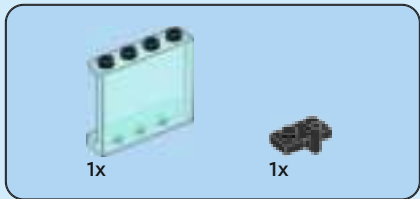

29

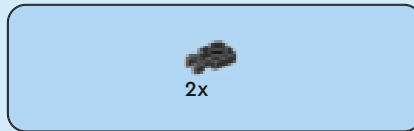
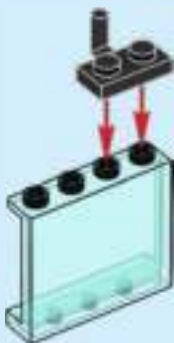

30



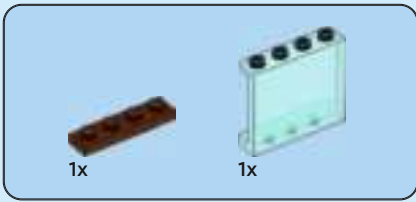

31

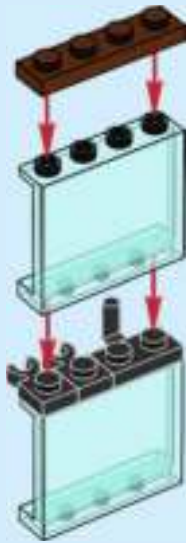

32

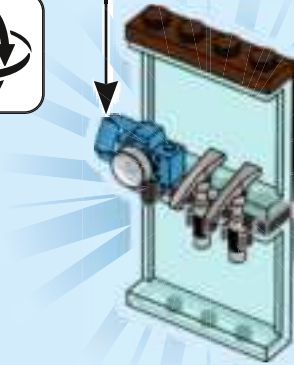
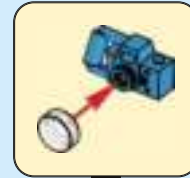

33

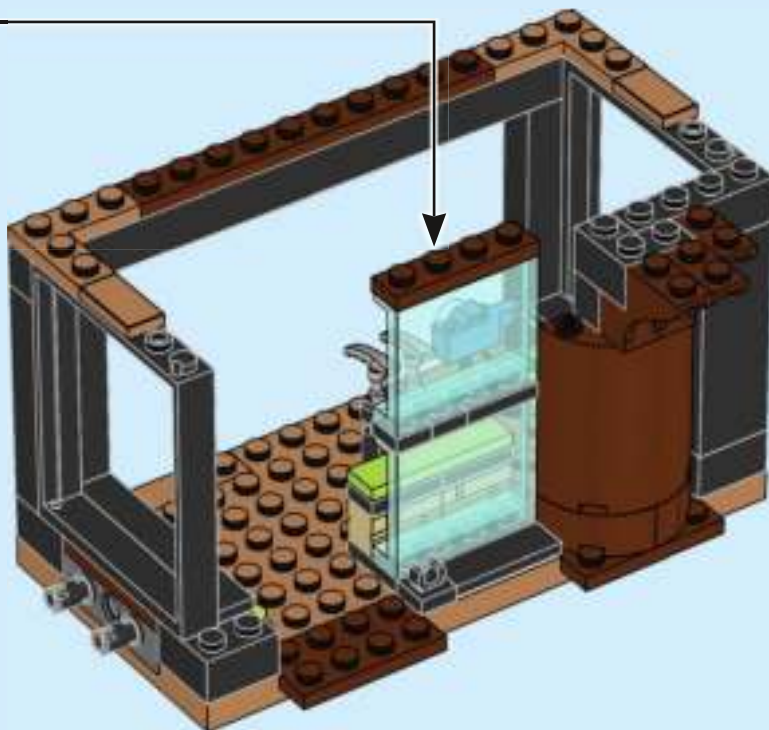





1x

34

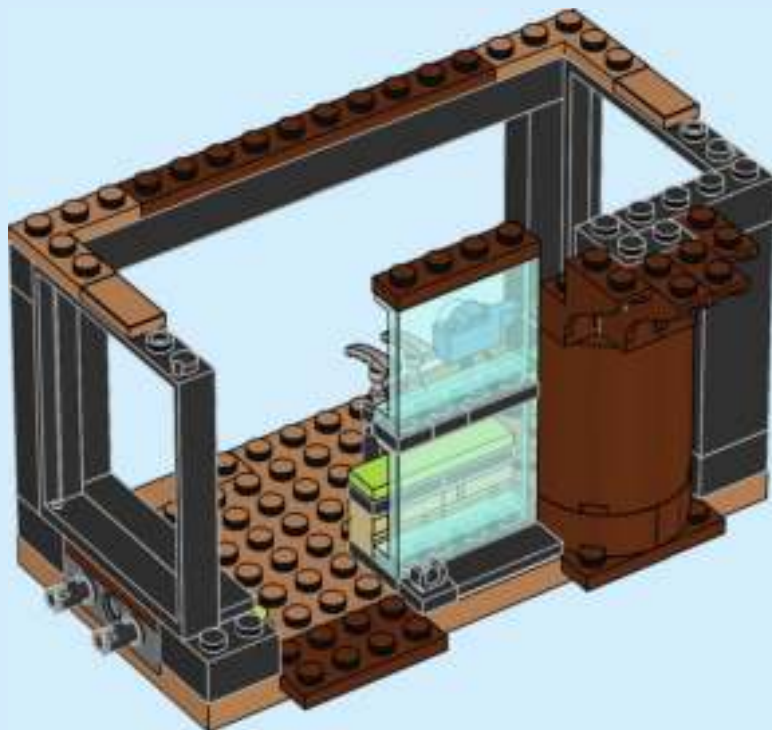



1x

35

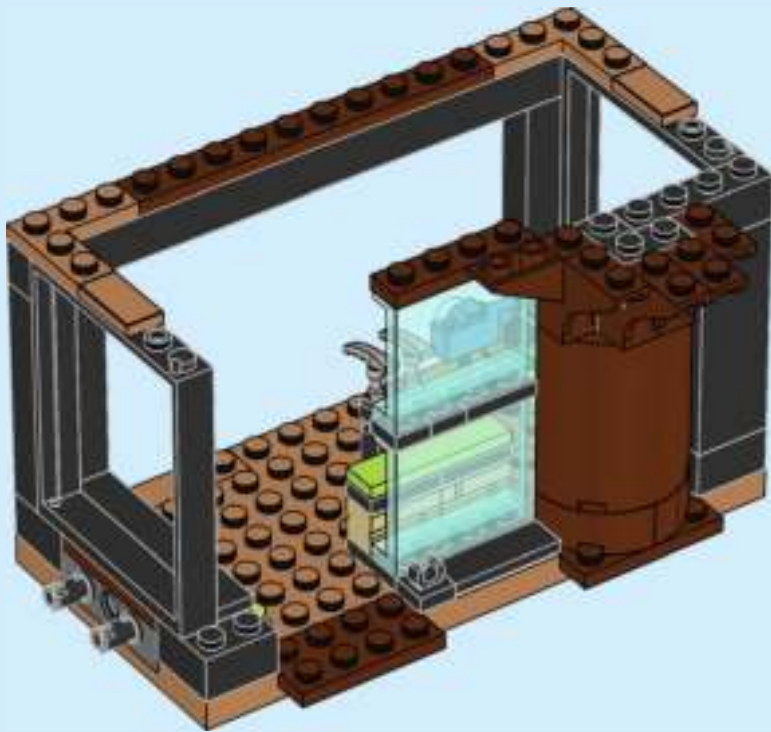



1x



3x

36

1

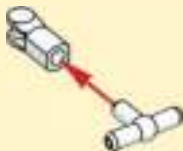

2

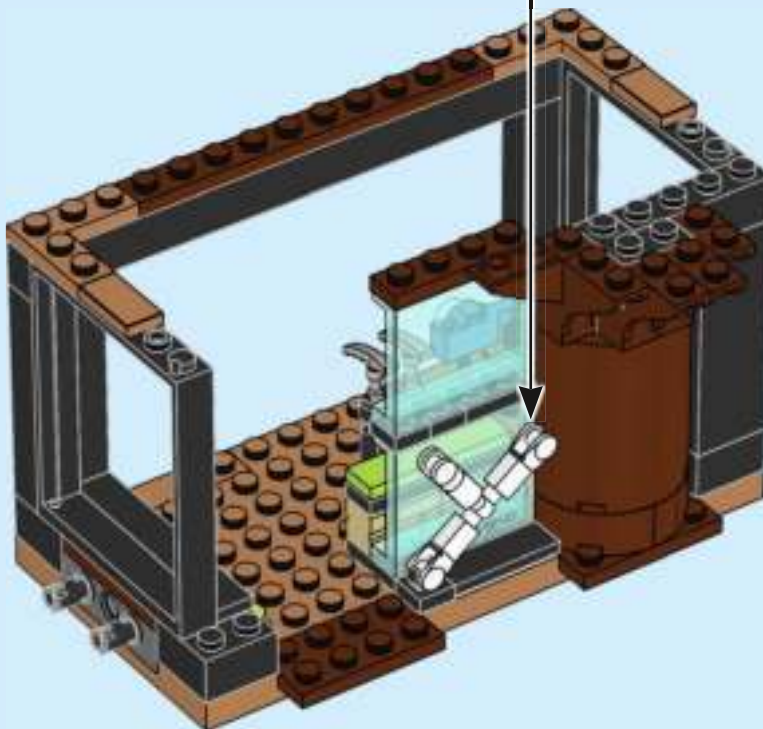
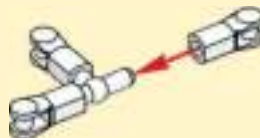

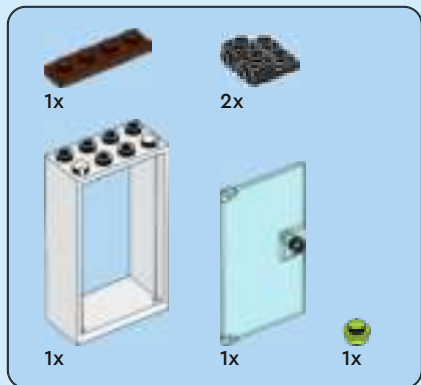

37

1

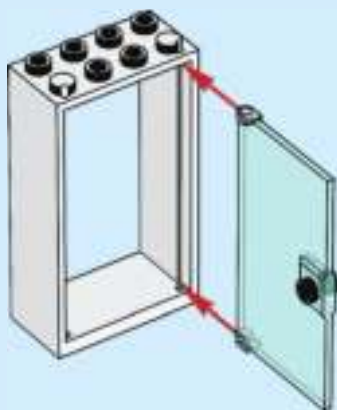

2

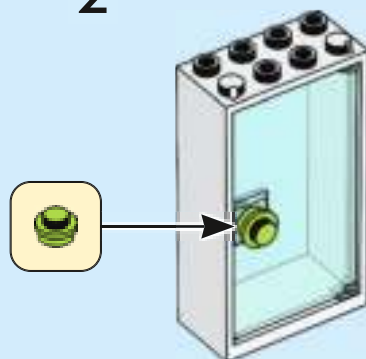

3



4

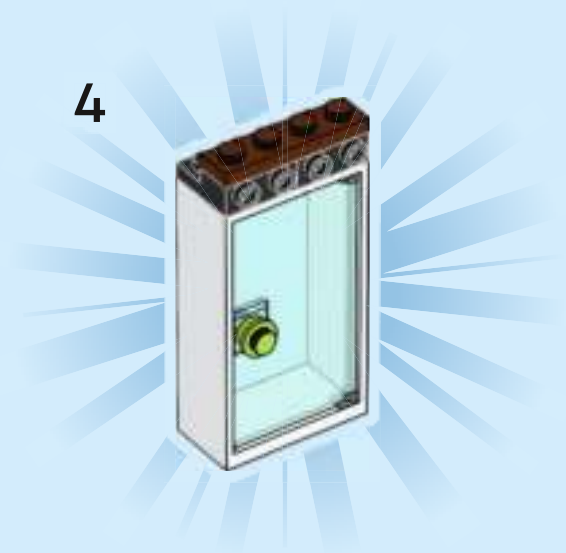

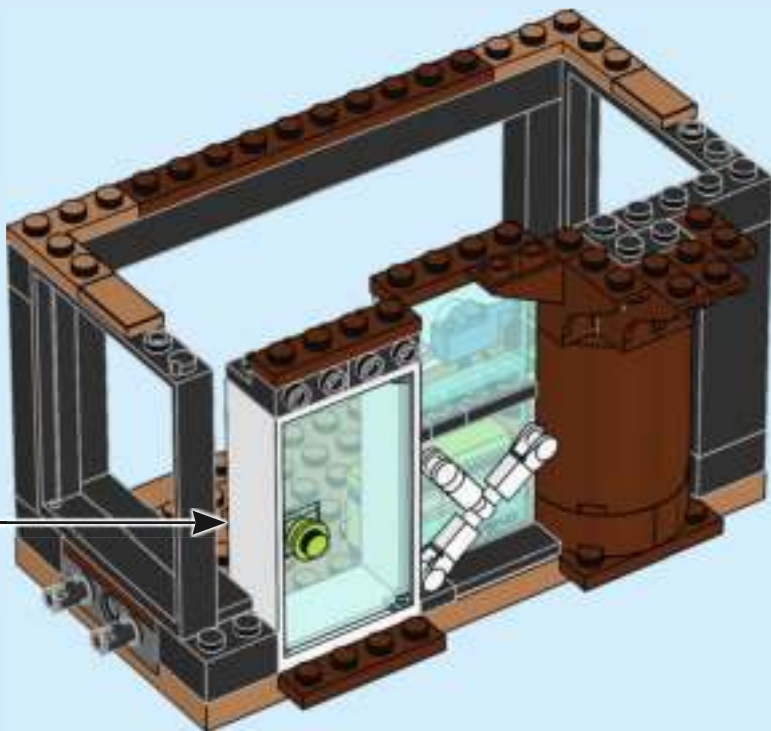

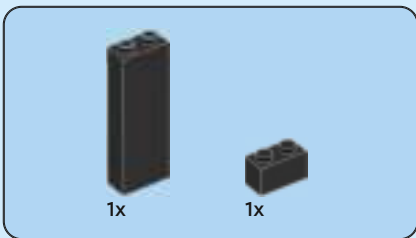

38

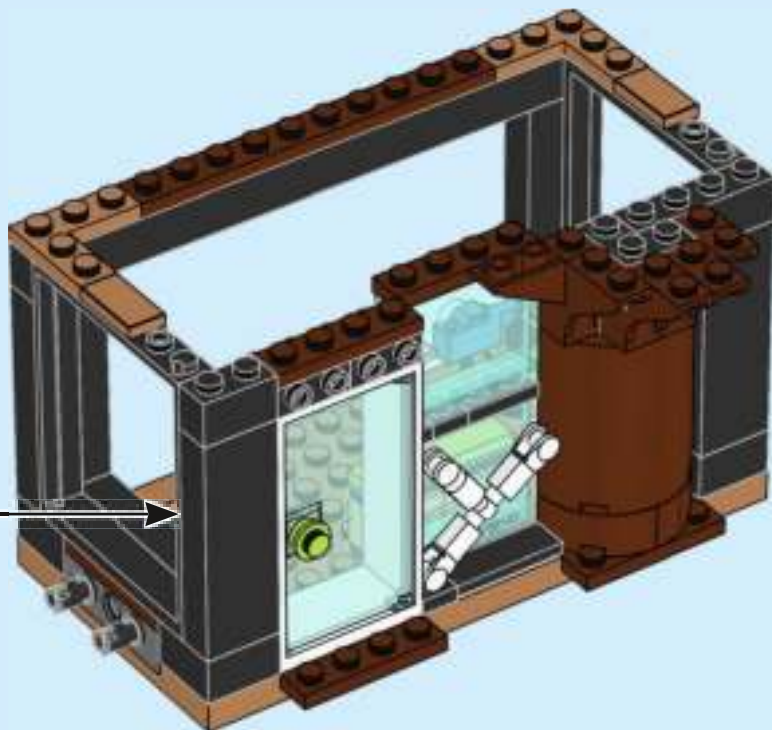

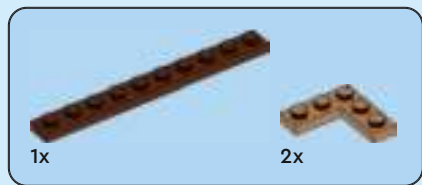

39

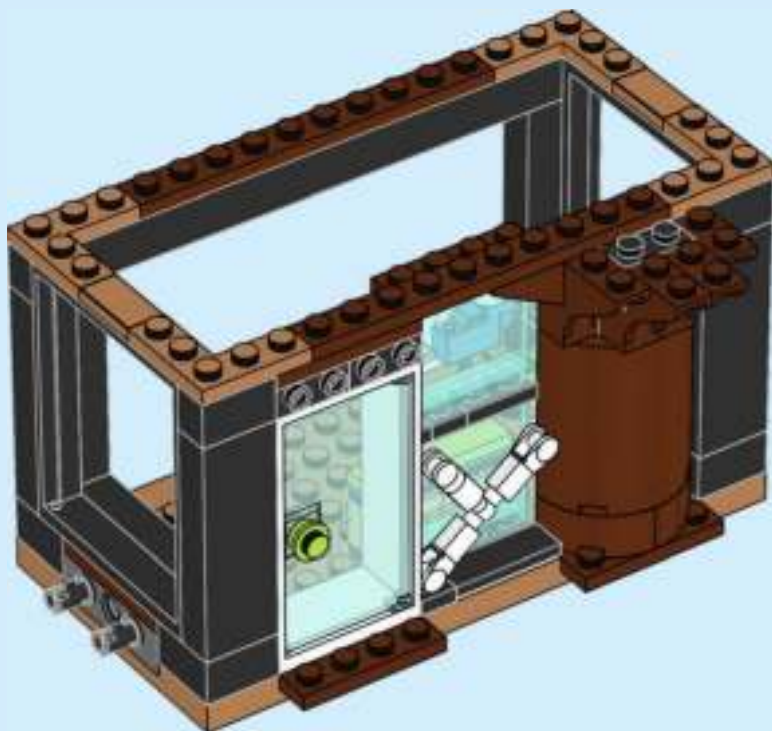





2x

40

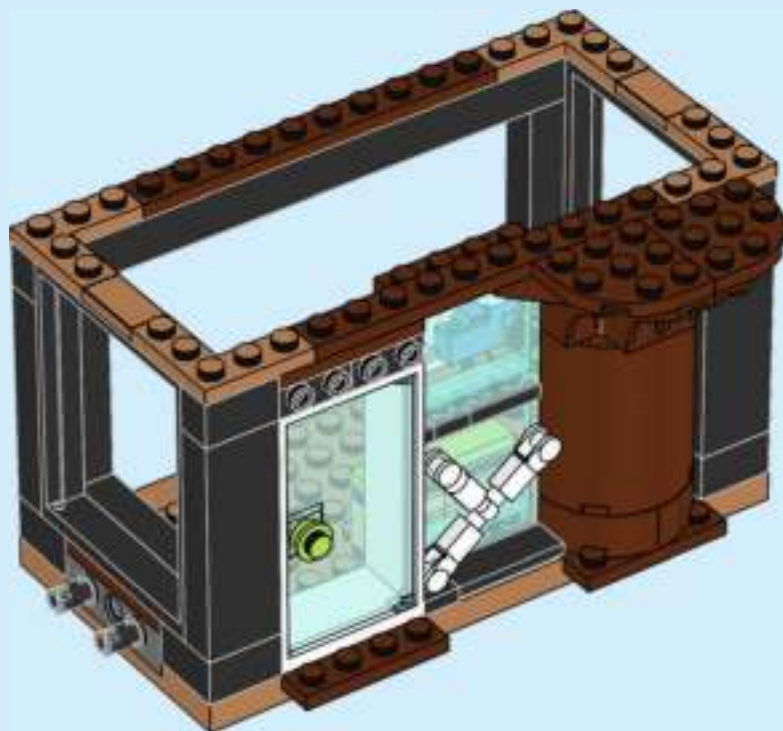

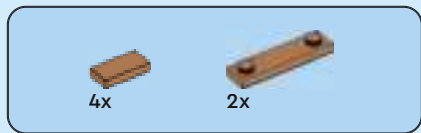

41

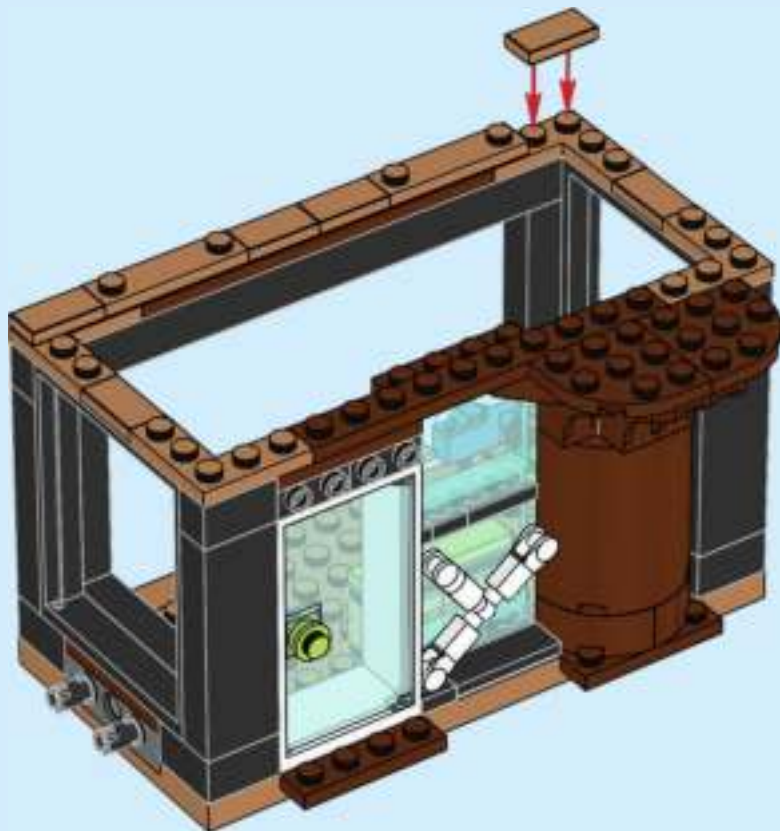

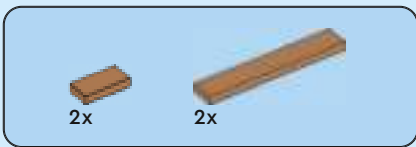

42

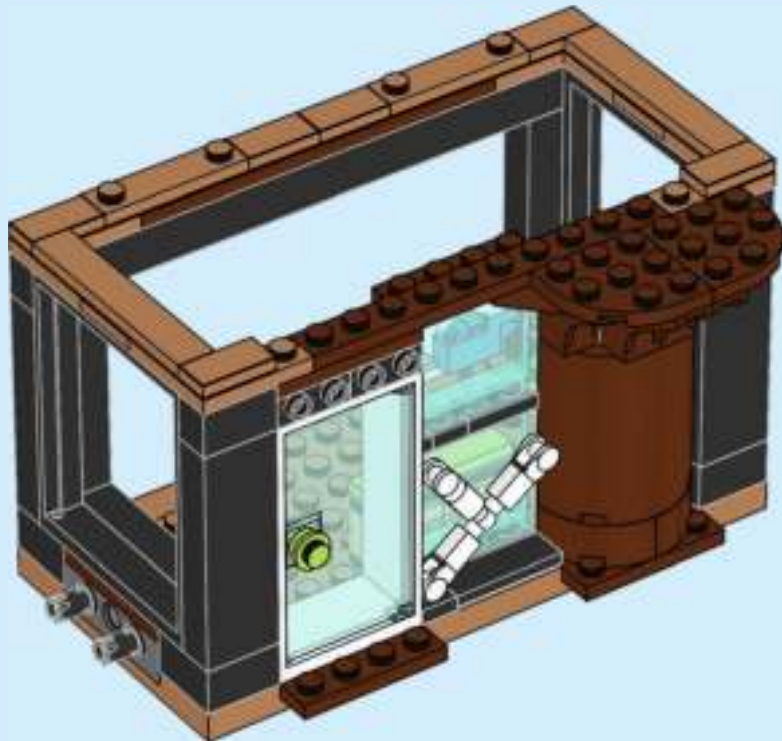



2x

43

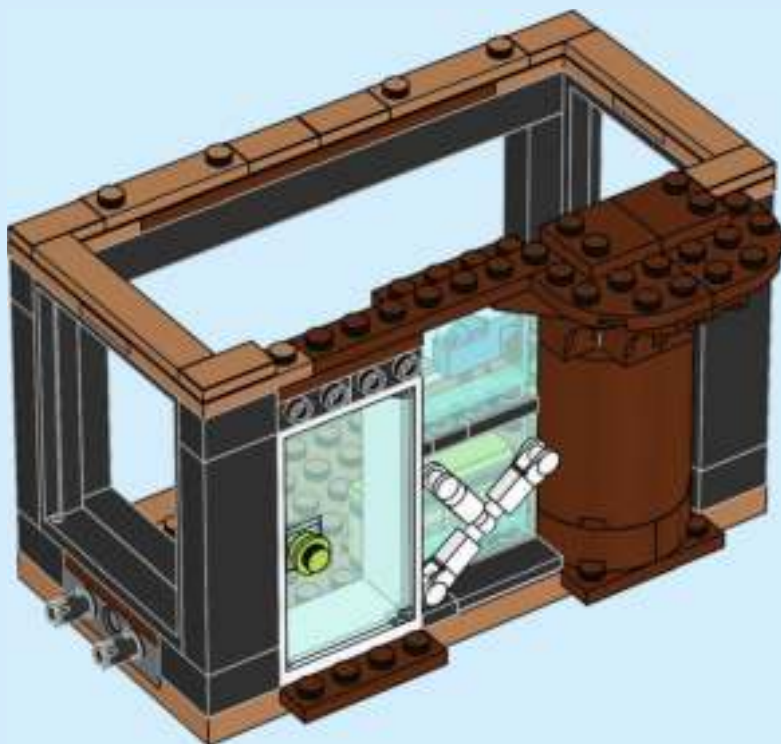



2x

44



2x

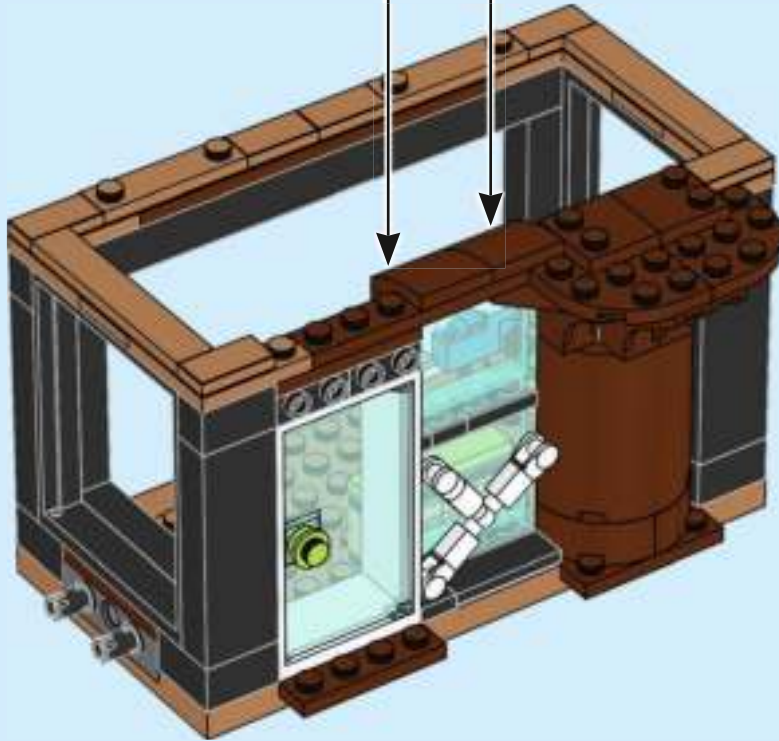



2x

45

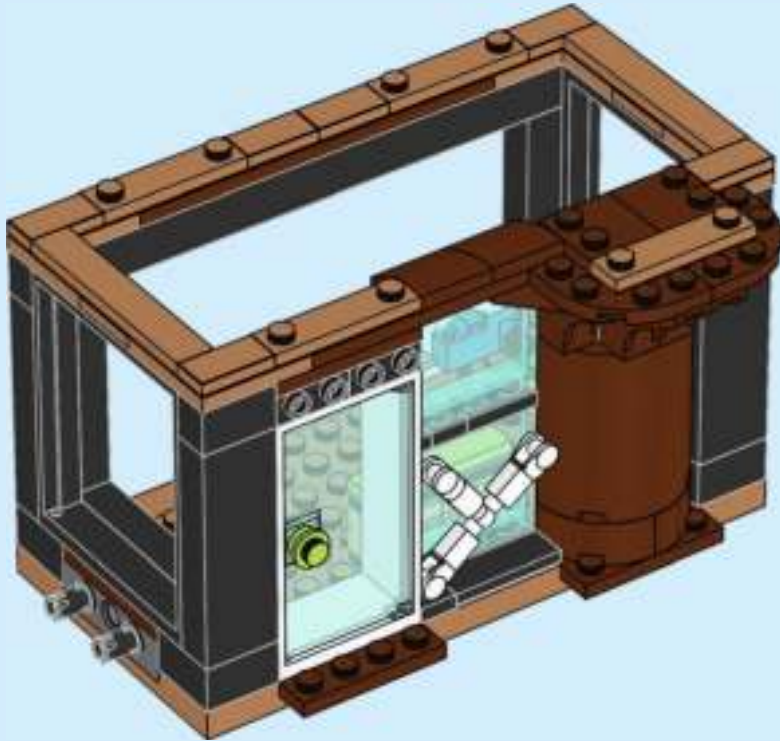



4x

46

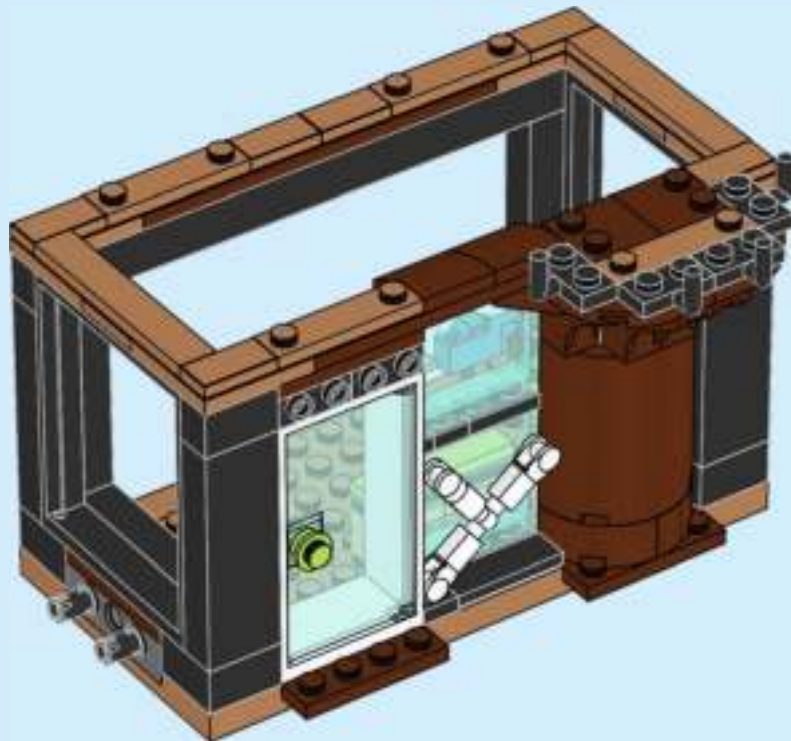



2x

47

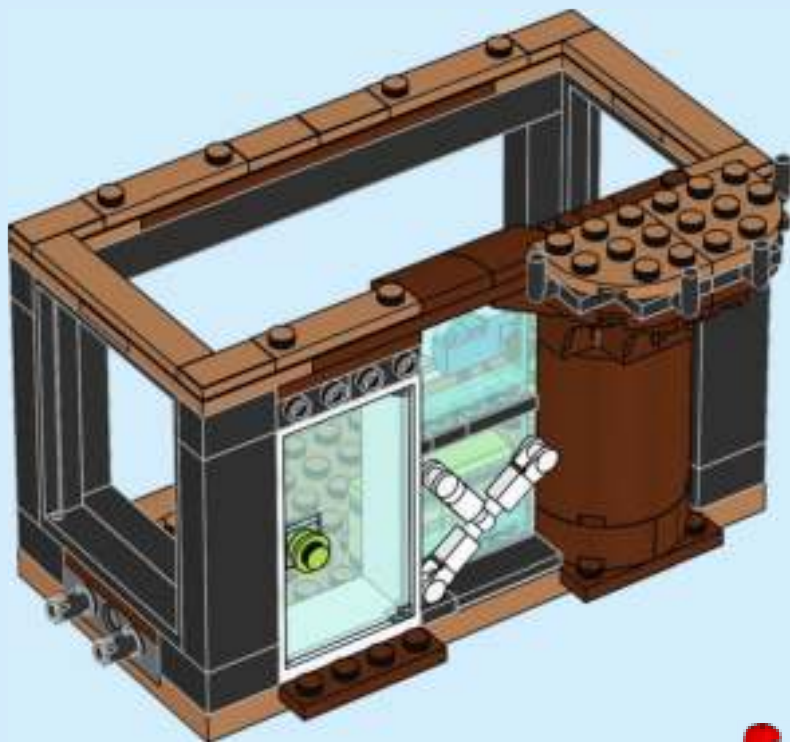



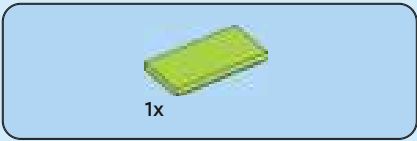

48

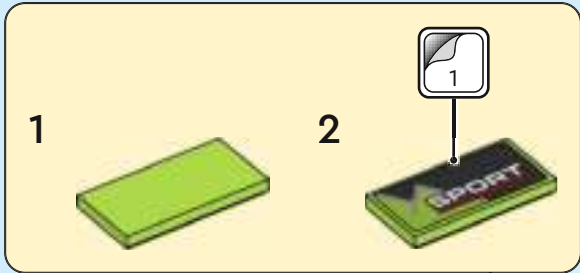



2x

49

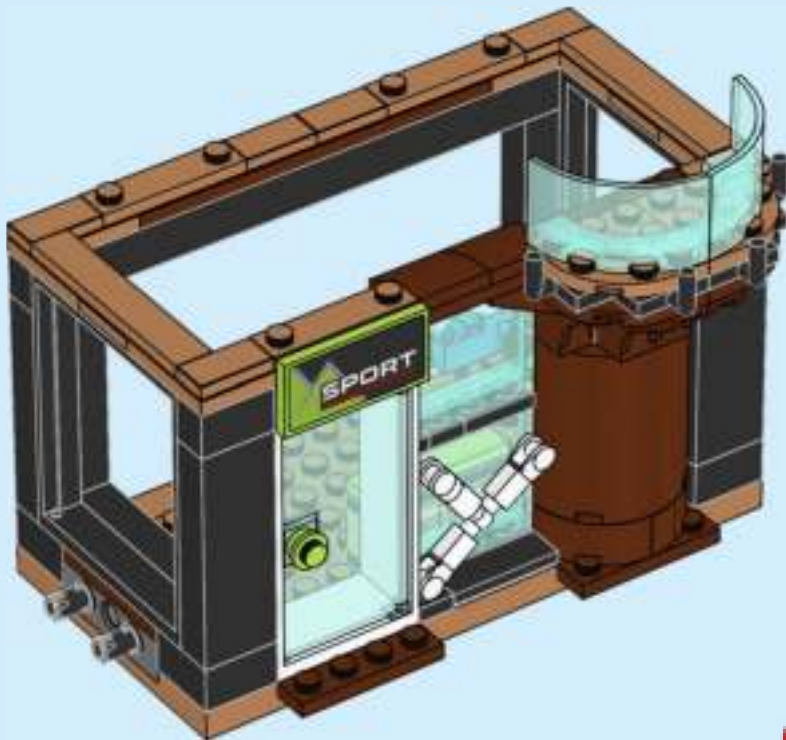



2x



1x

50

1



2

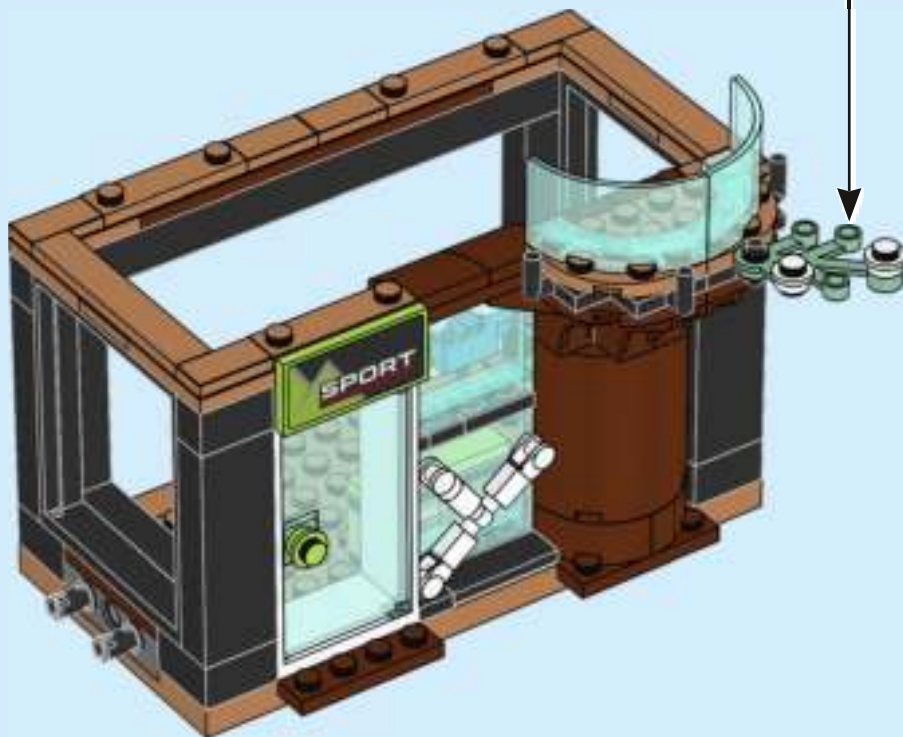



51

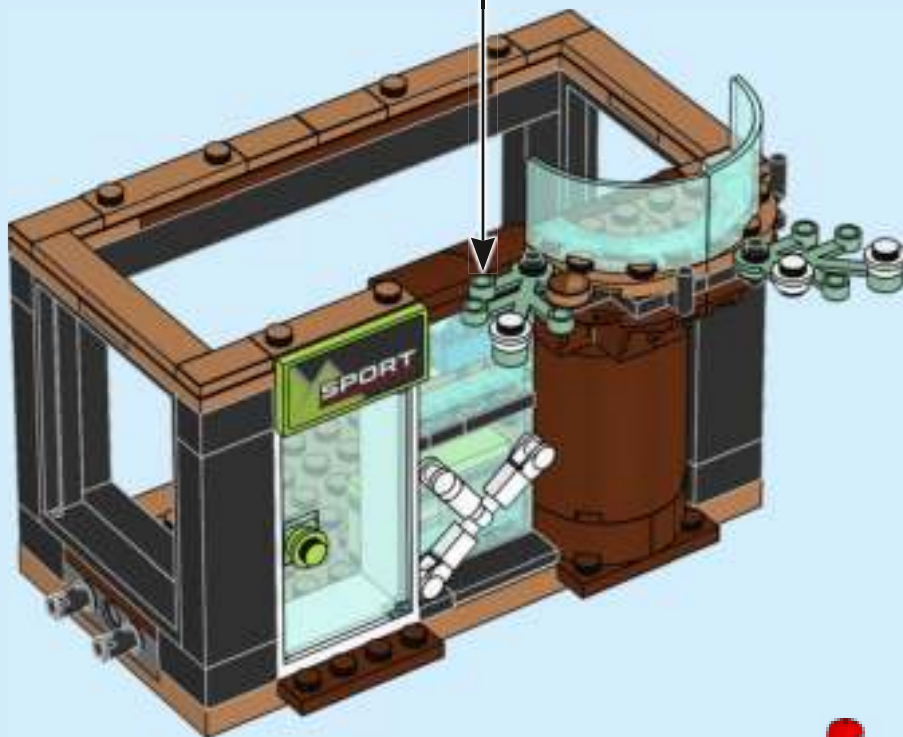

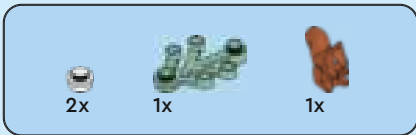

52

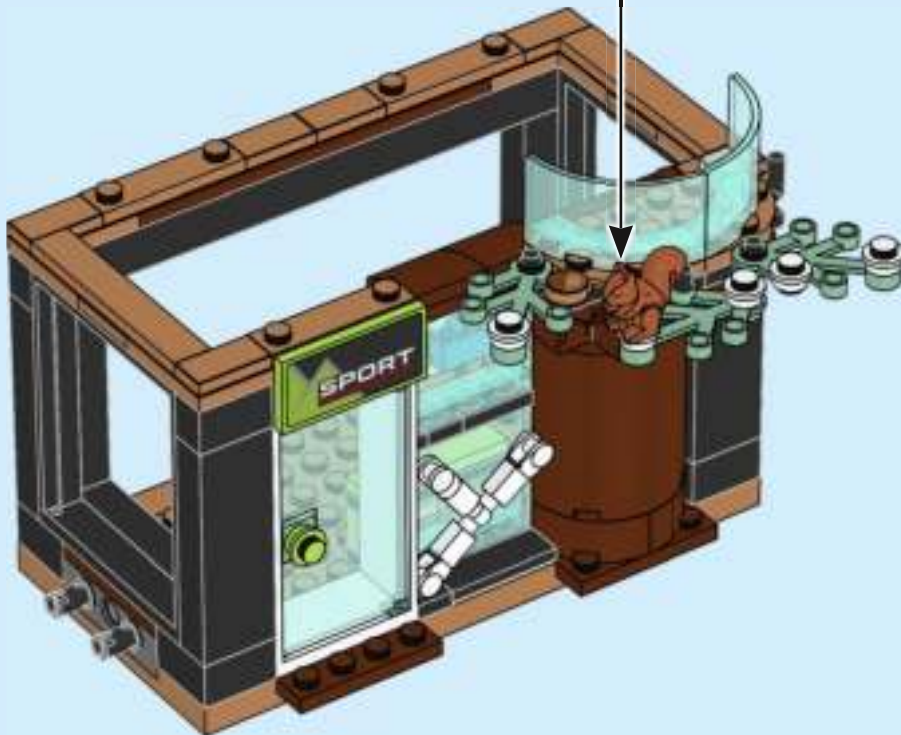

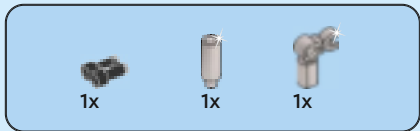

53

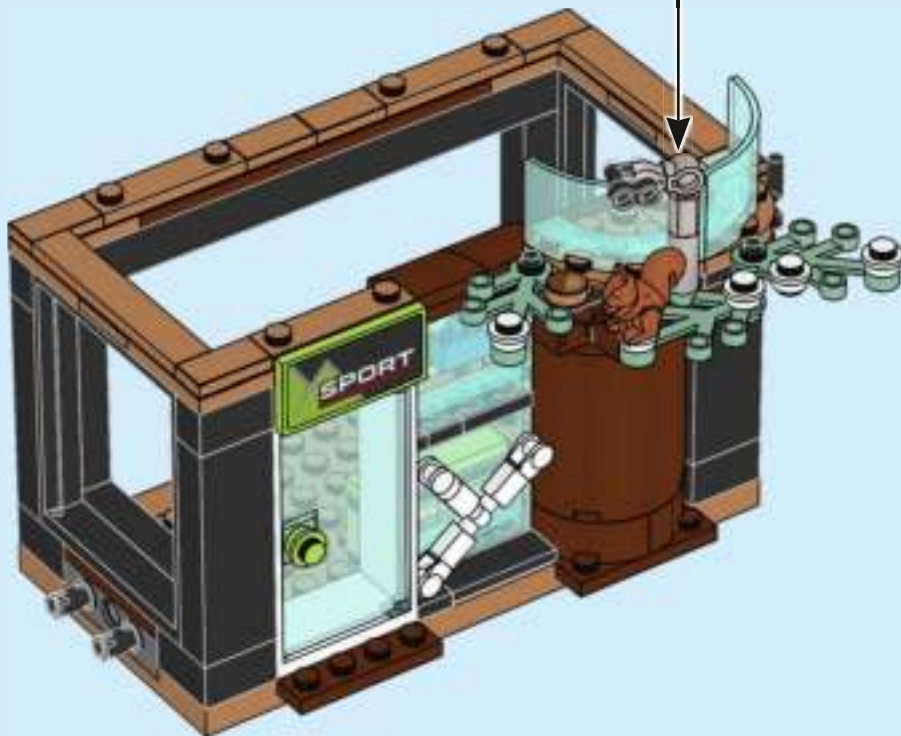
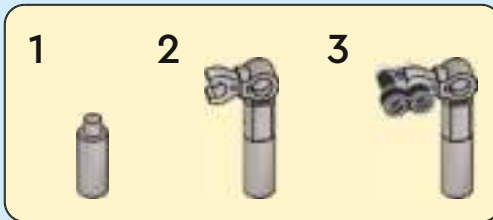



1x



1x

54

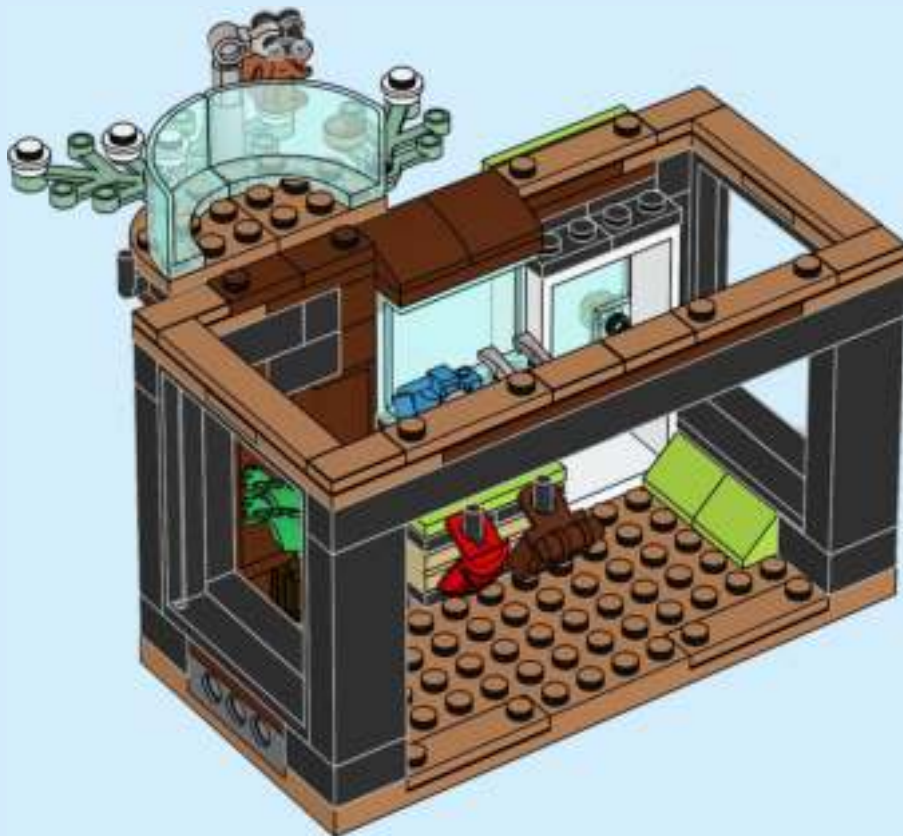

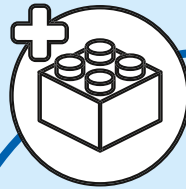



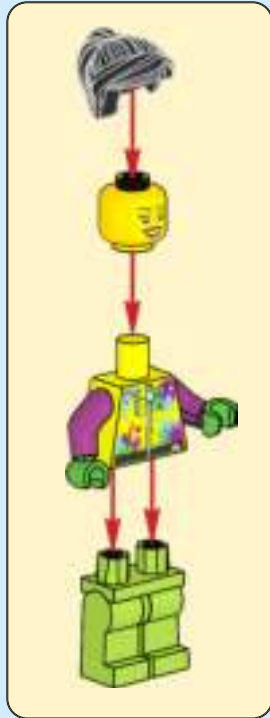

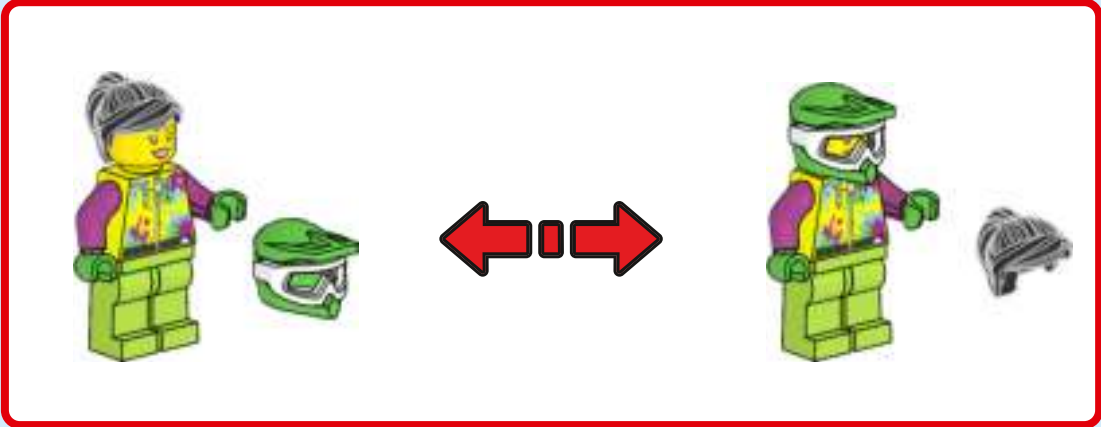

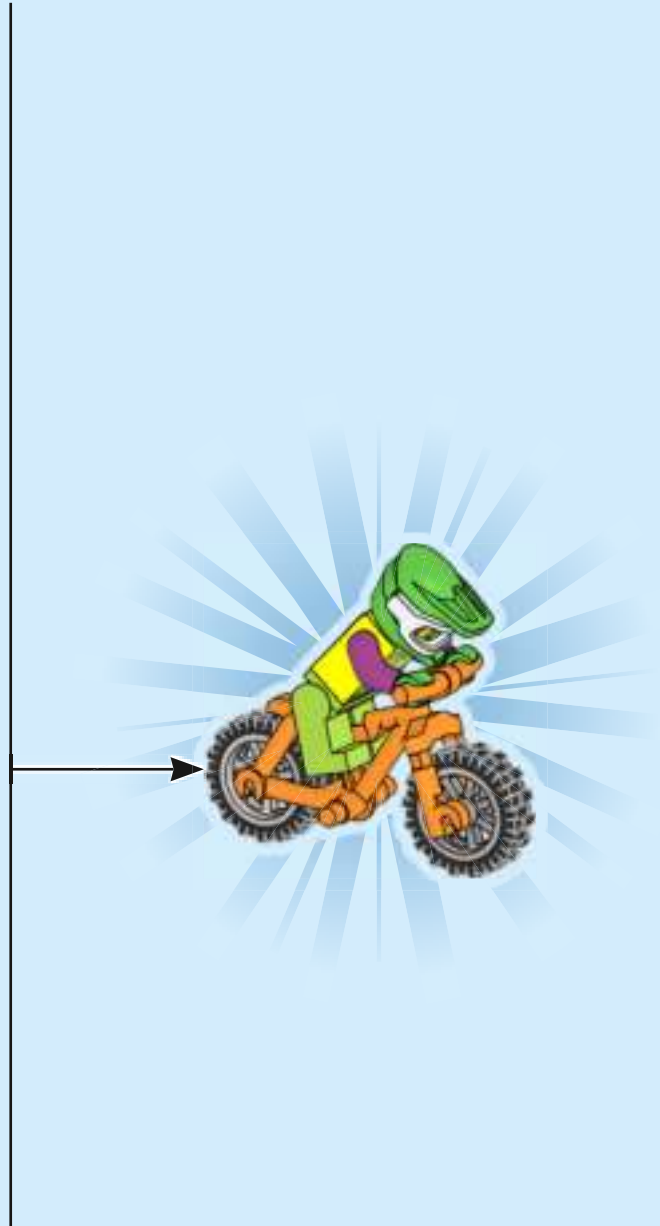
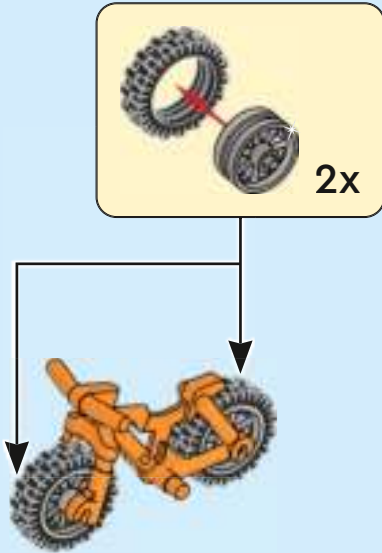

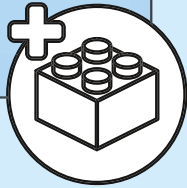
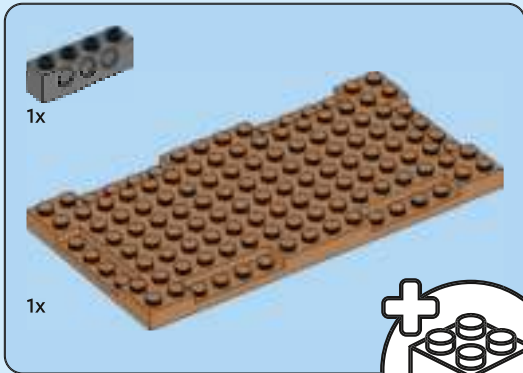
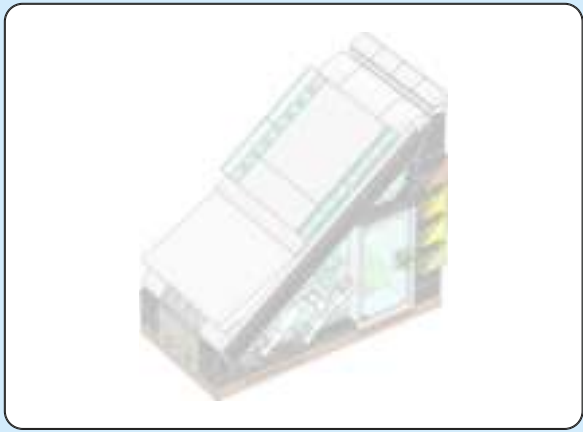

55

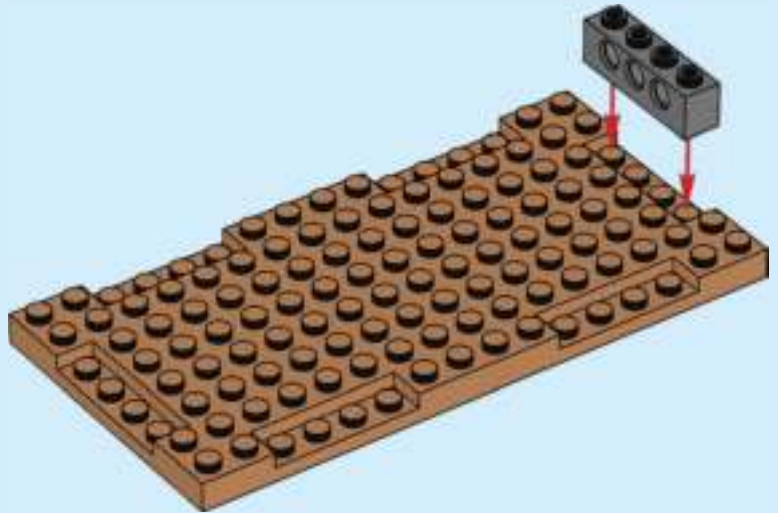



56

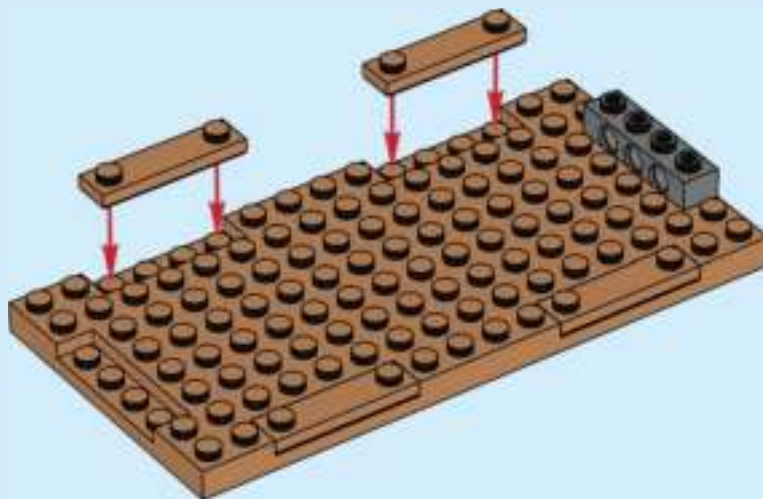



2x



1x

57

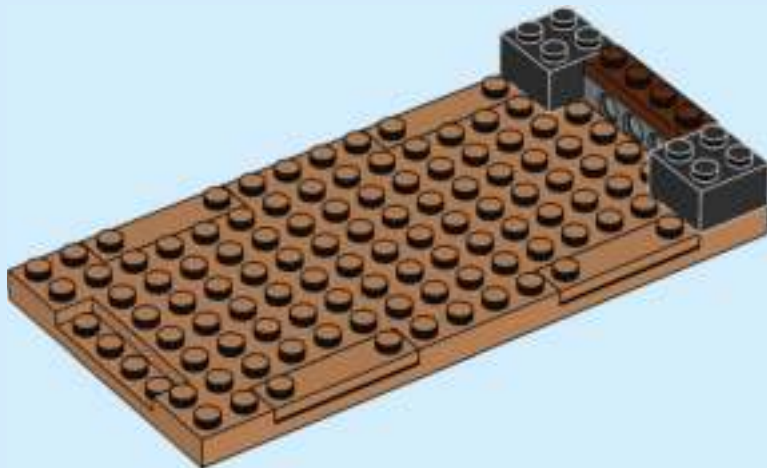



2x

58

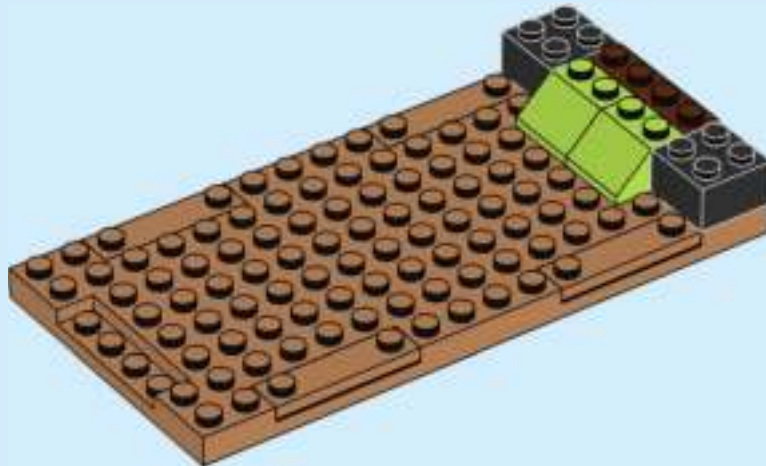

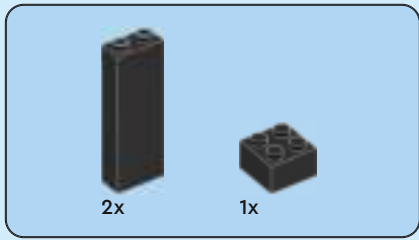

59

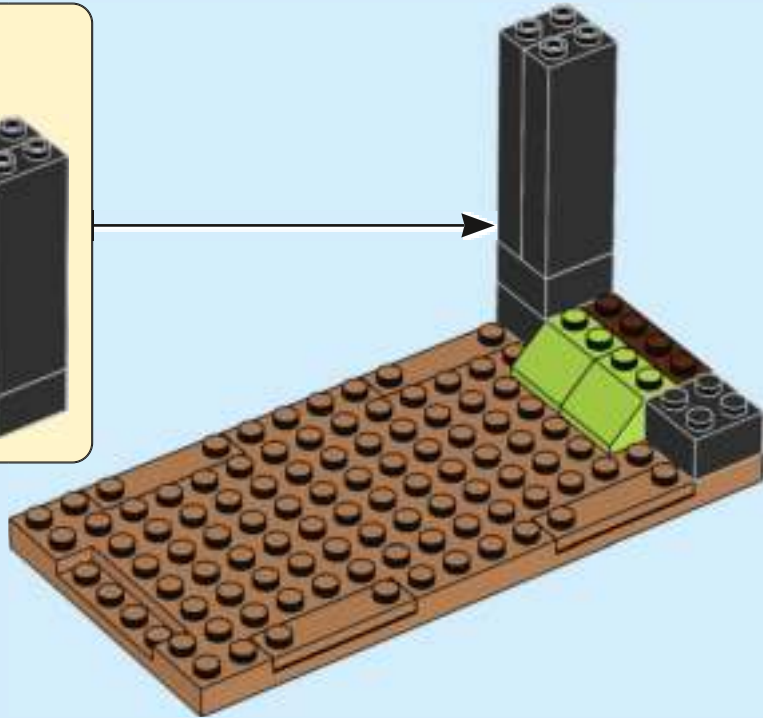
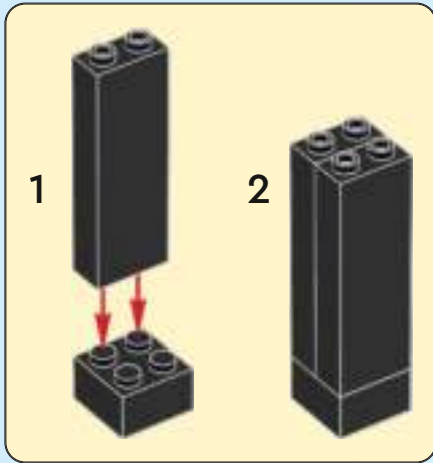



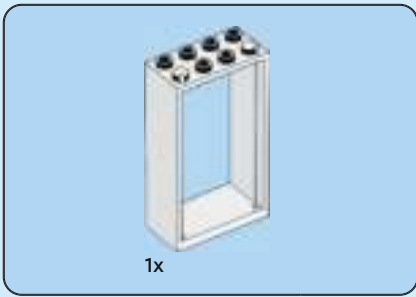

60

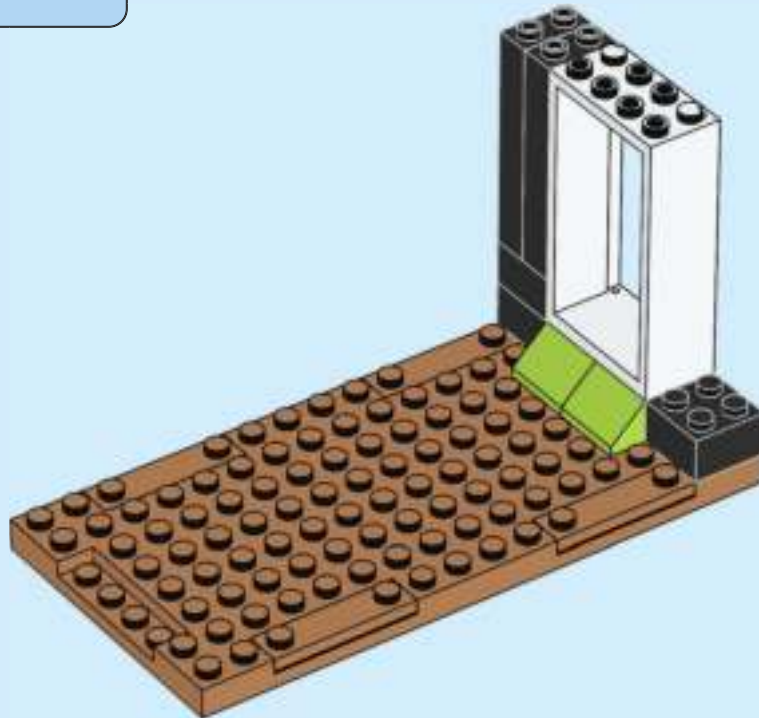

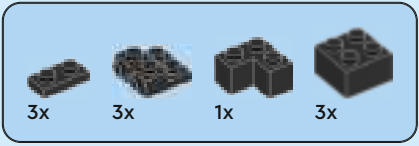

# 61

1



2



3



4



5



6



7

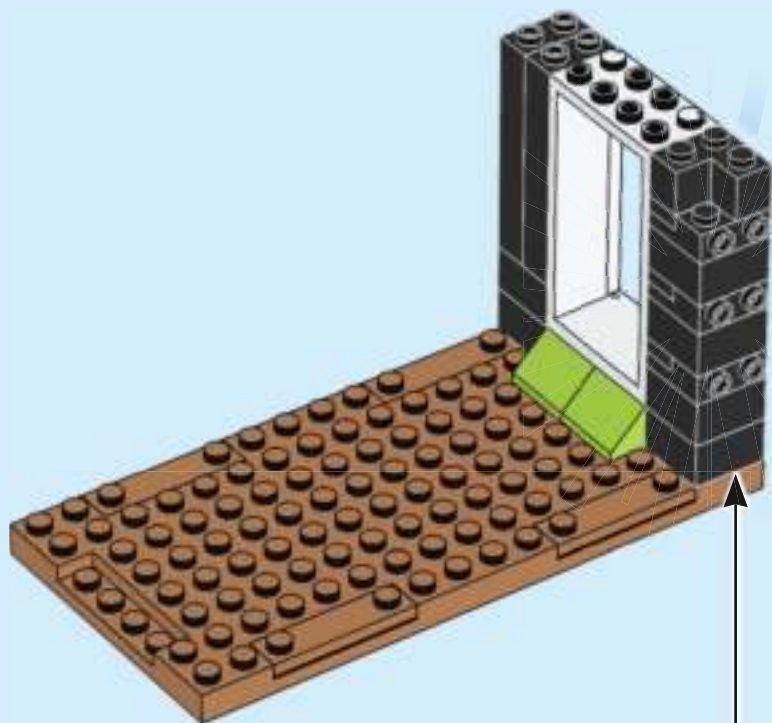

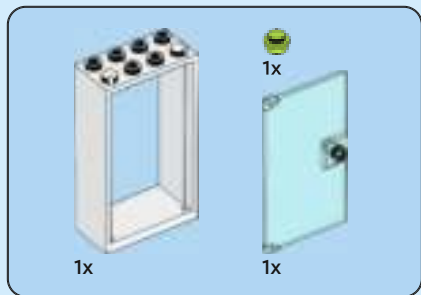

62

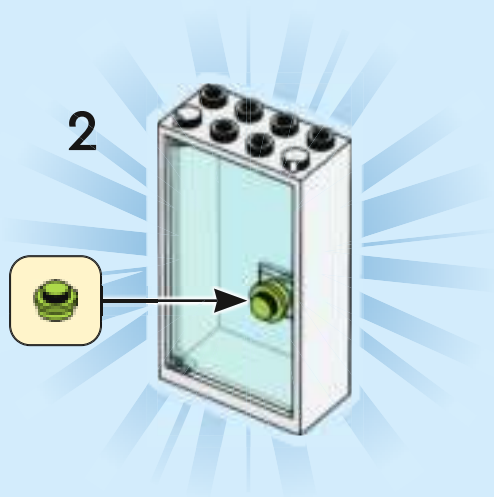
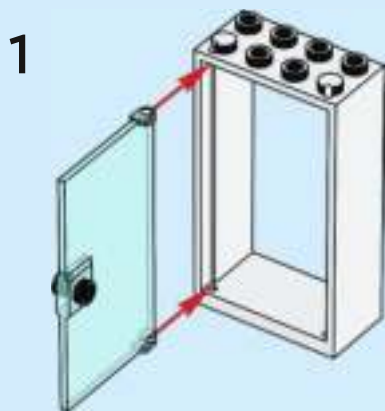

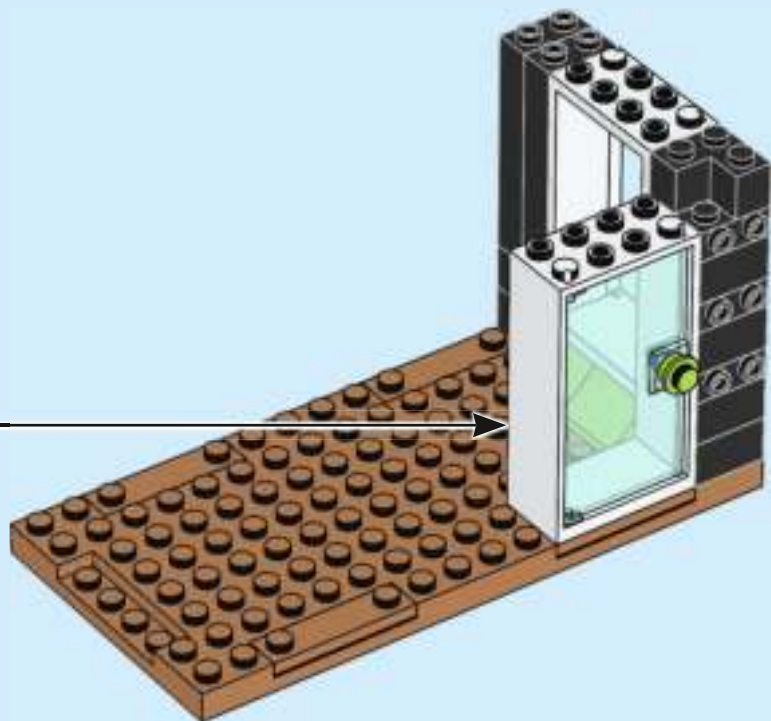



1x



1x

63

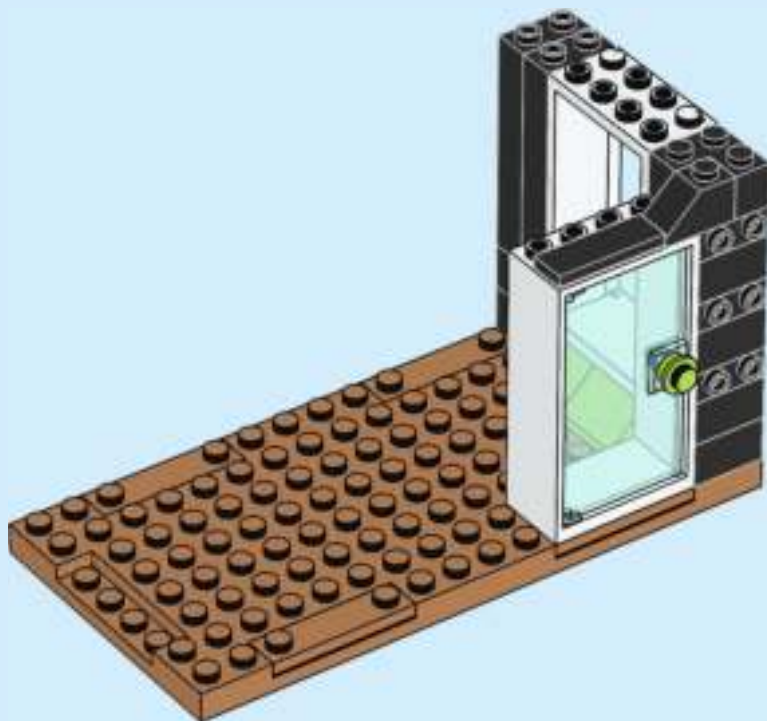



1x



2x

64

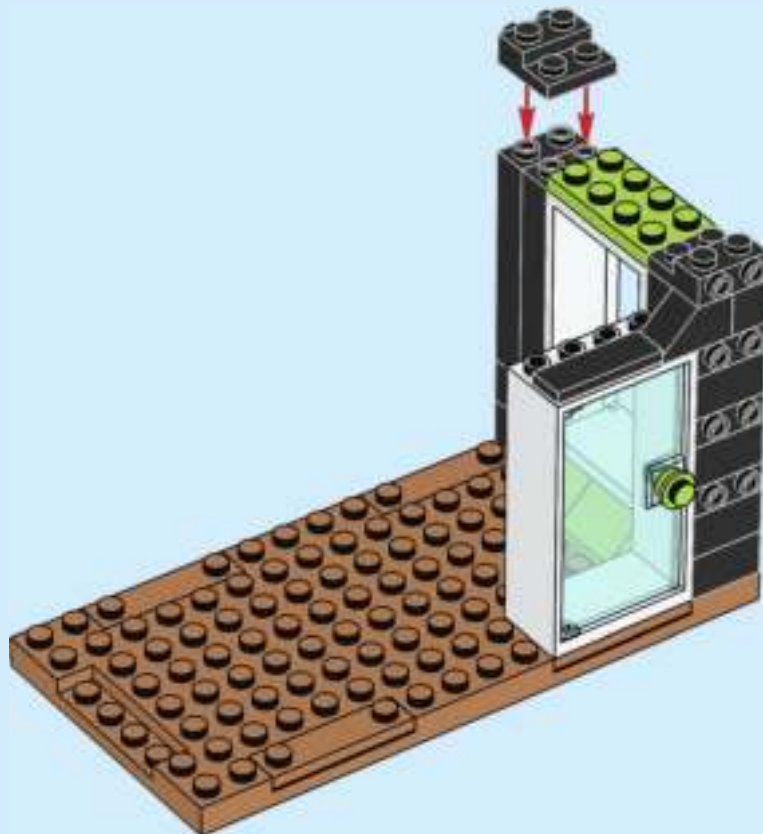



65

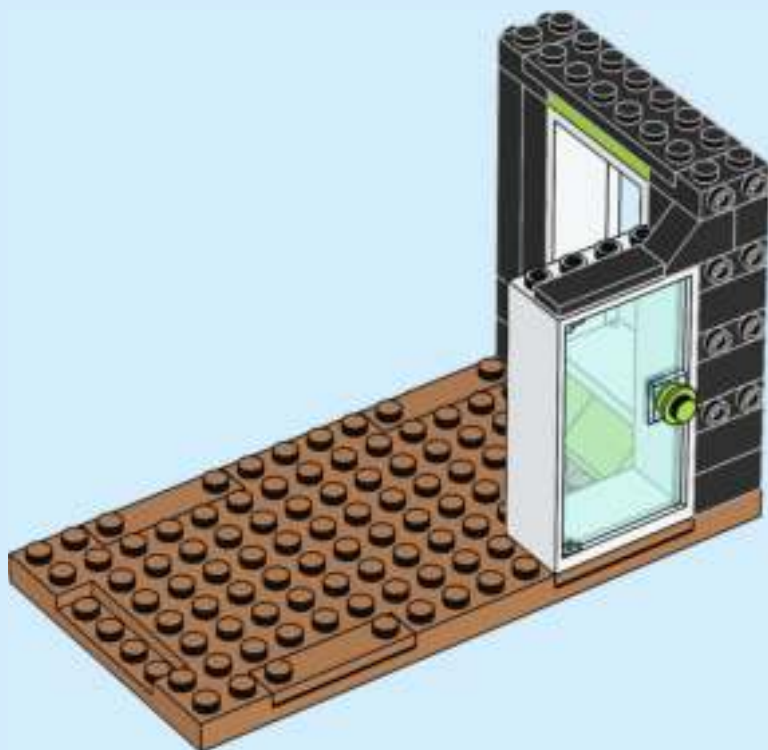



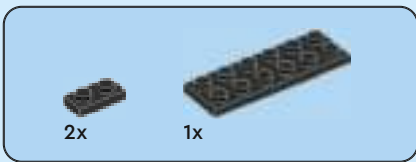

66

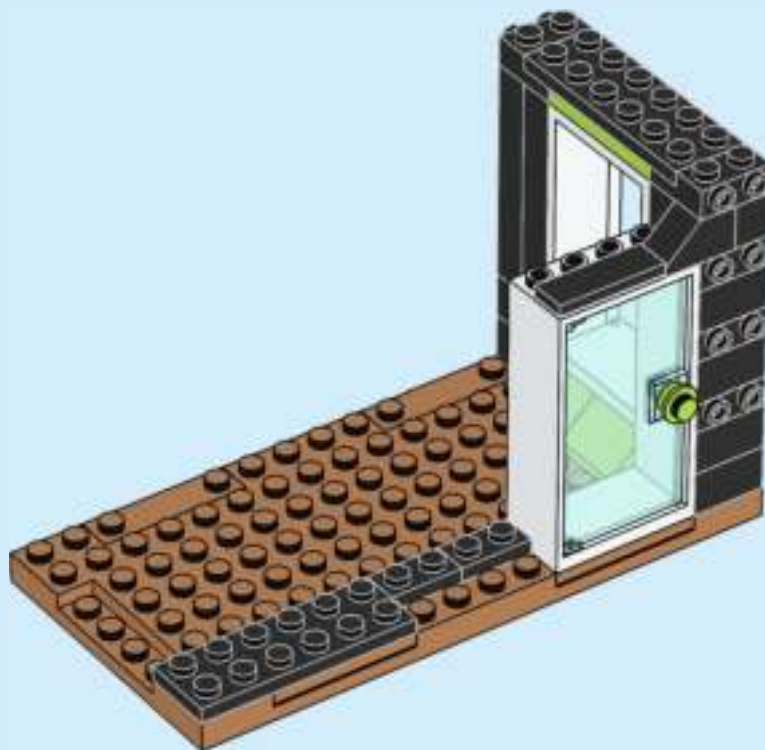



1x



1x

67

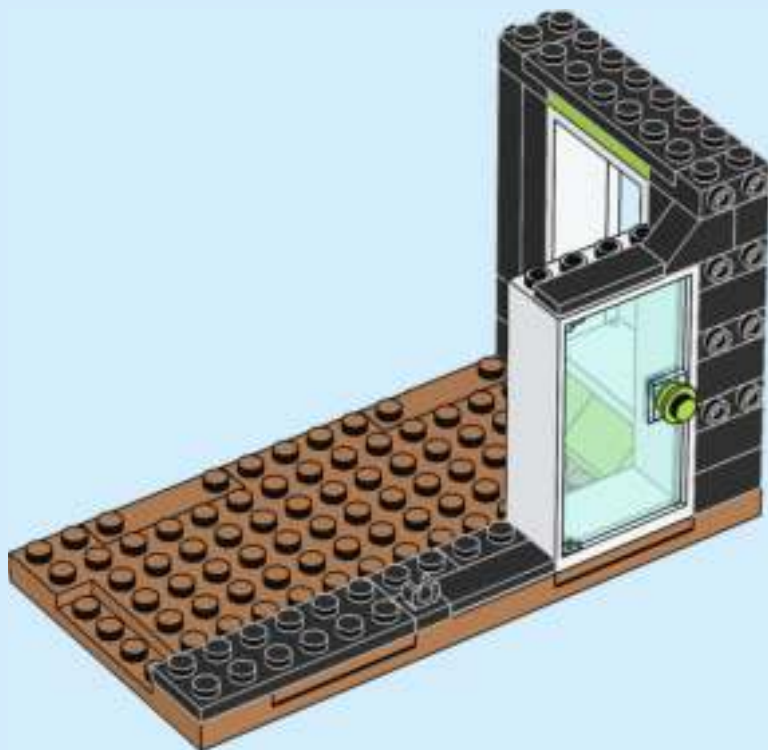



2x

68

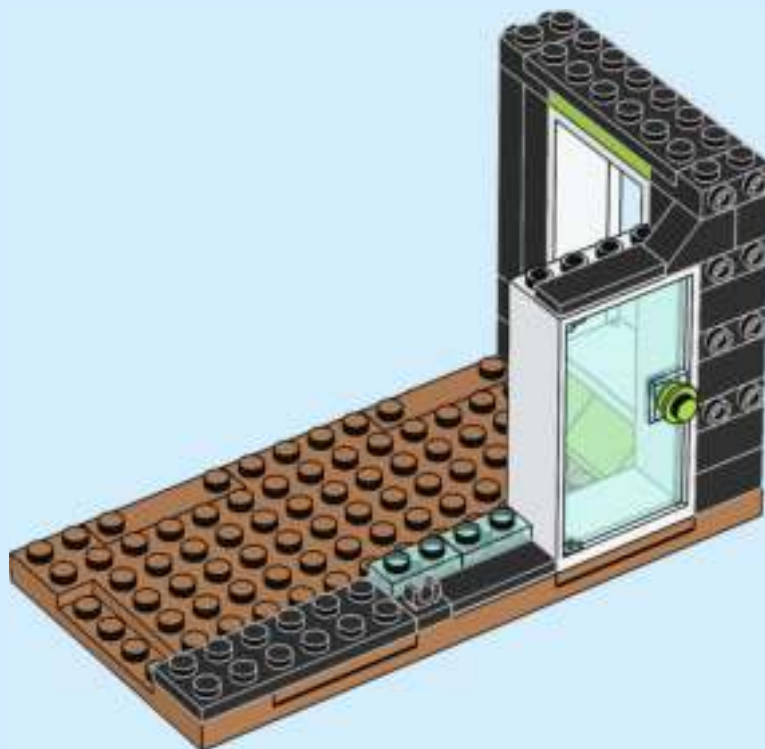

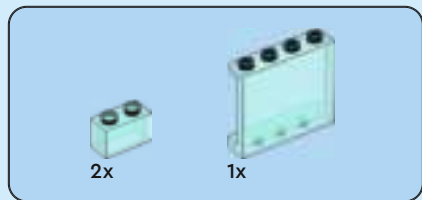

69

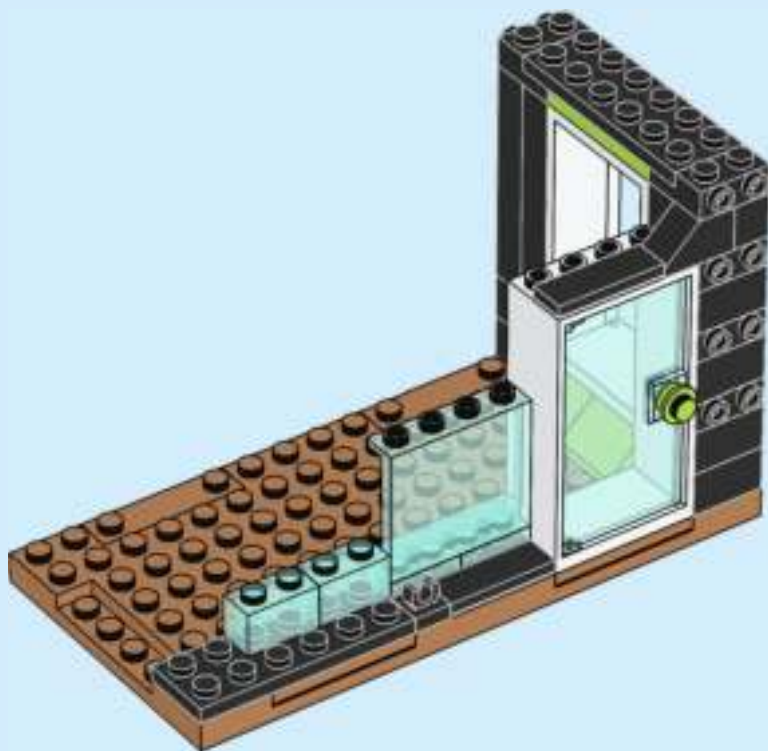



1x



1x

70

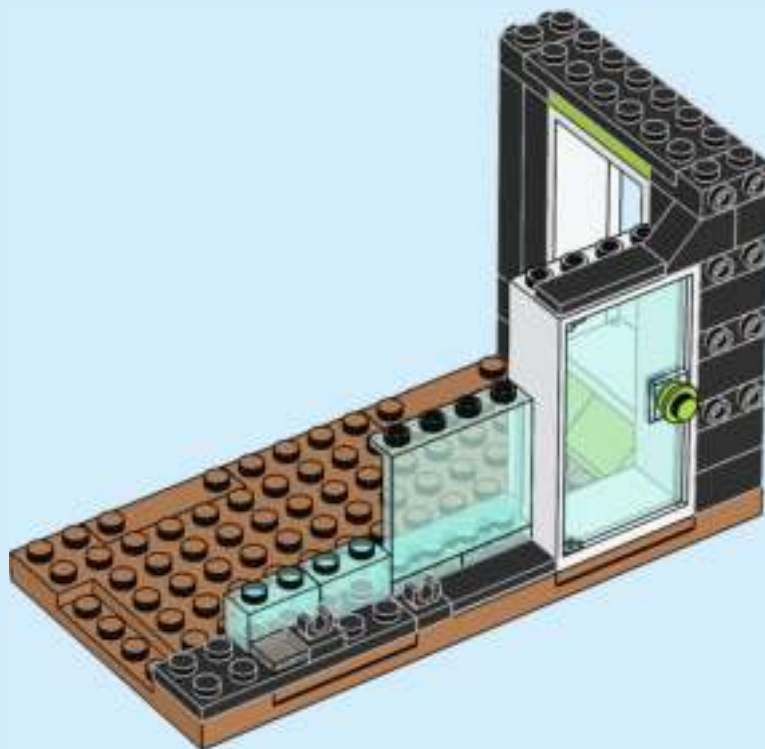



2x

71

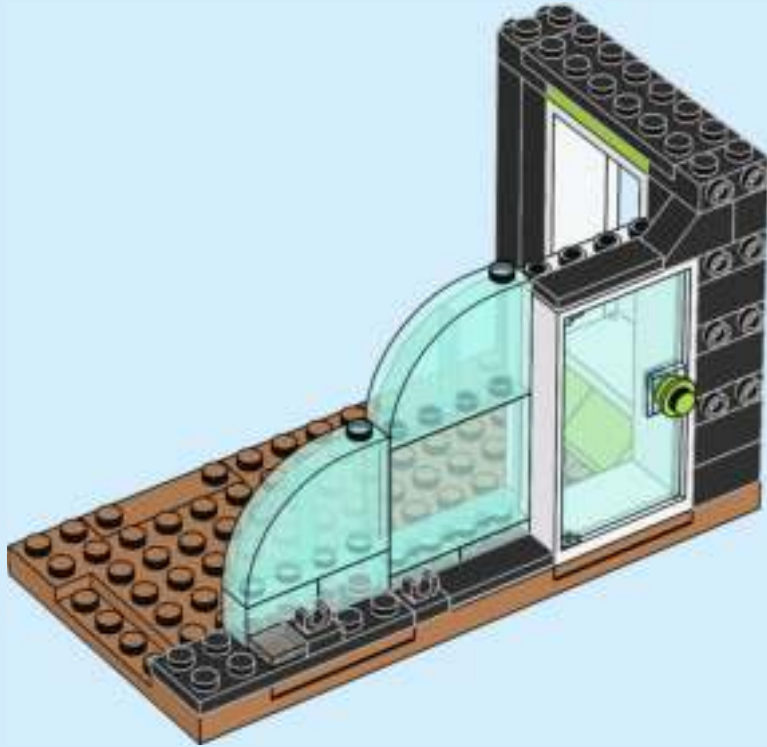

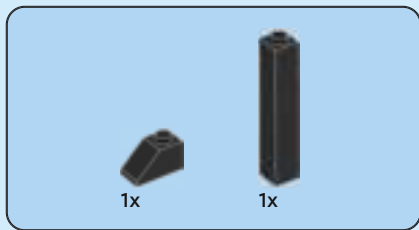

72

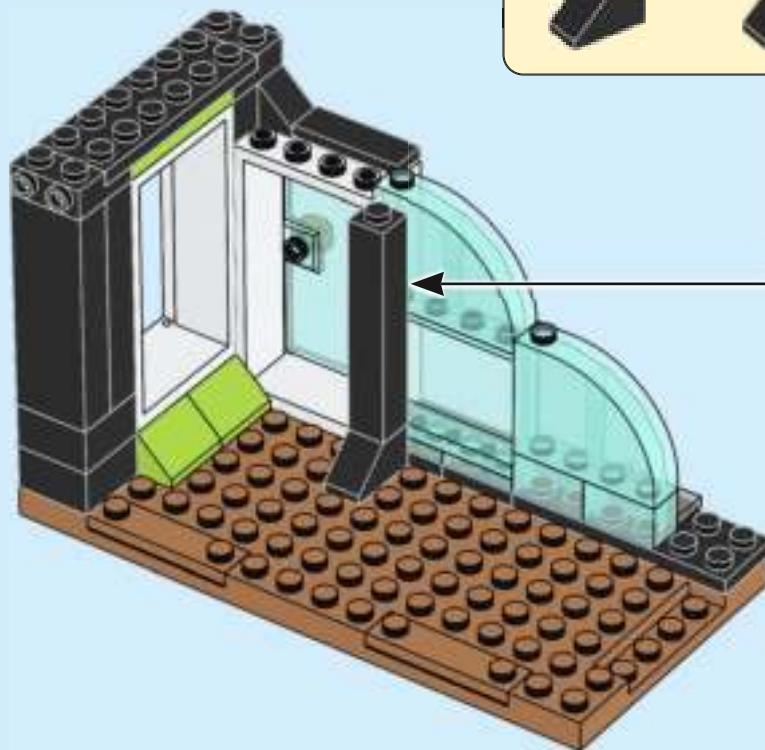
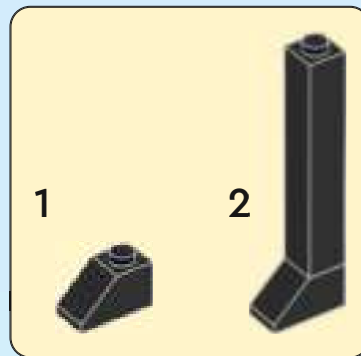



73

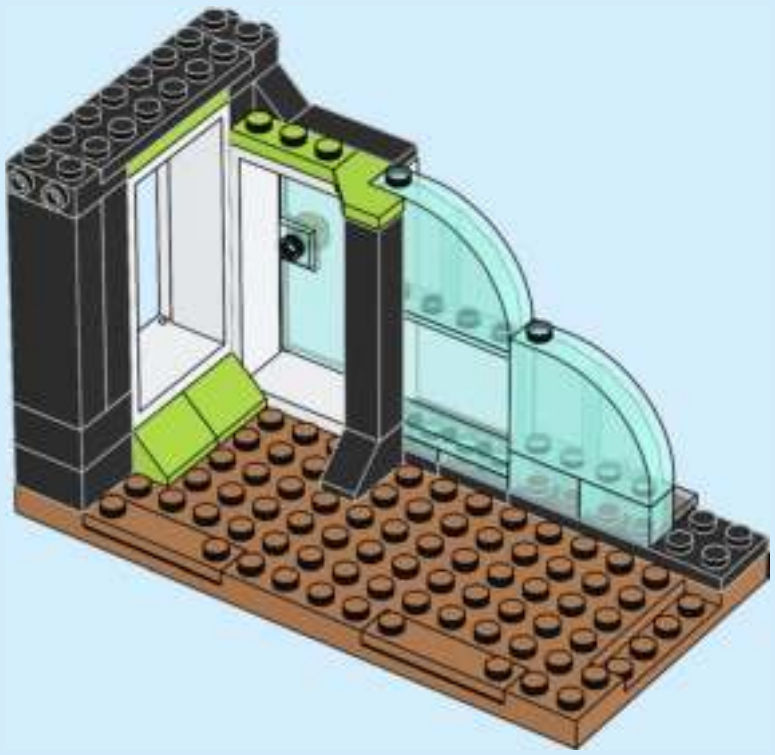



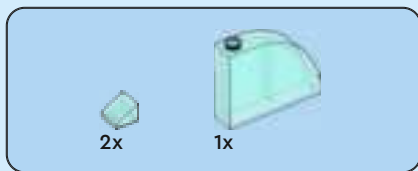

74

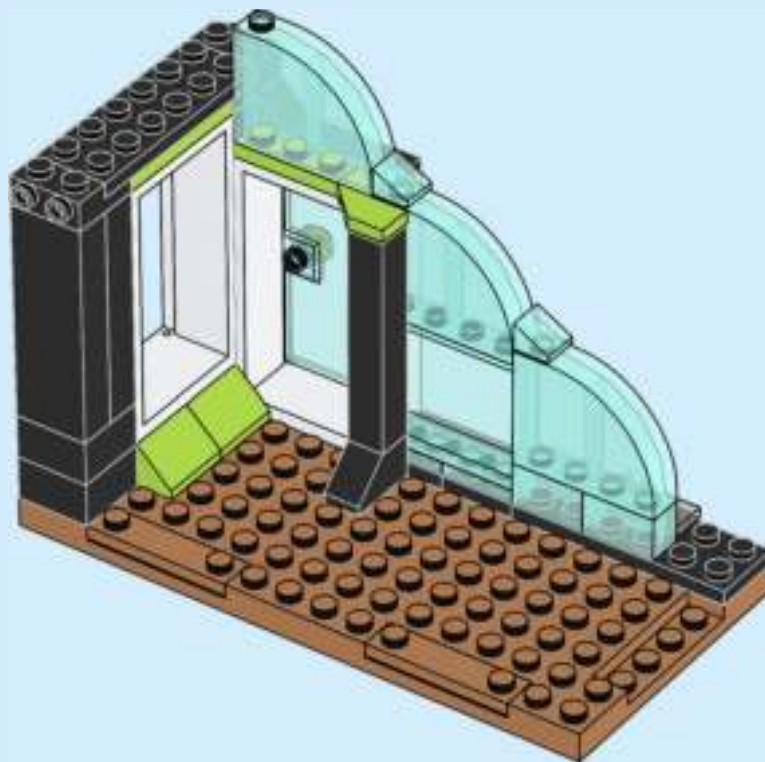

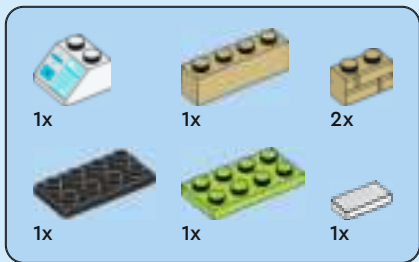

75

1



2



3

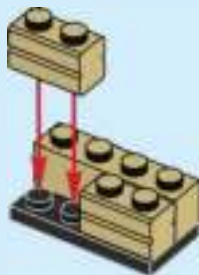

4



5



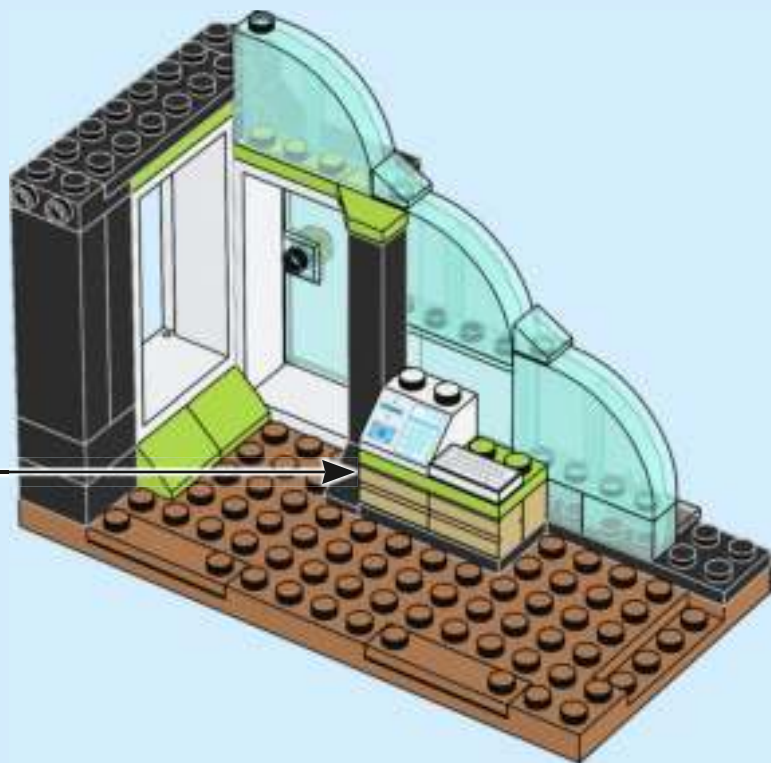



2x

76

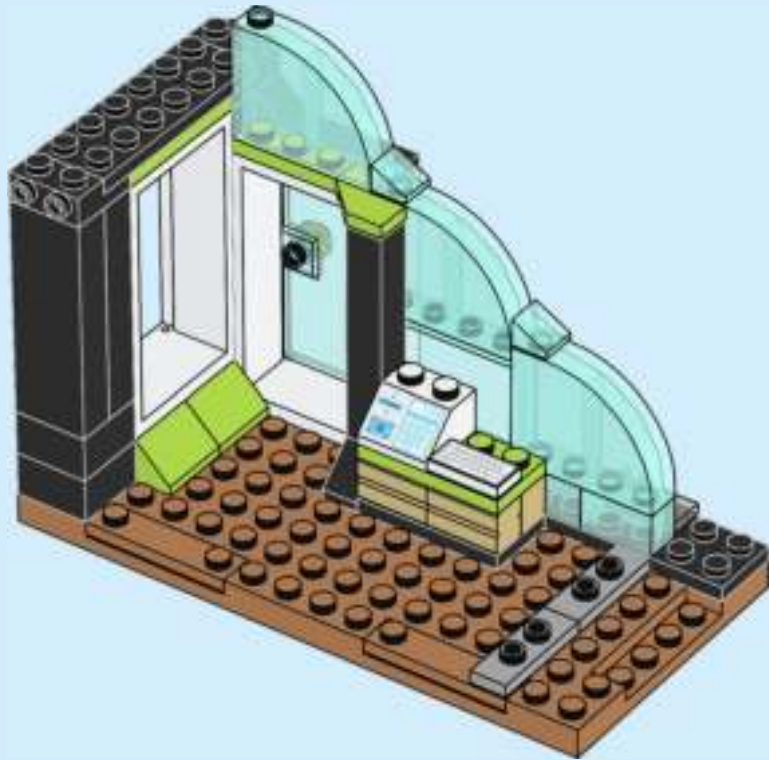



2x

77

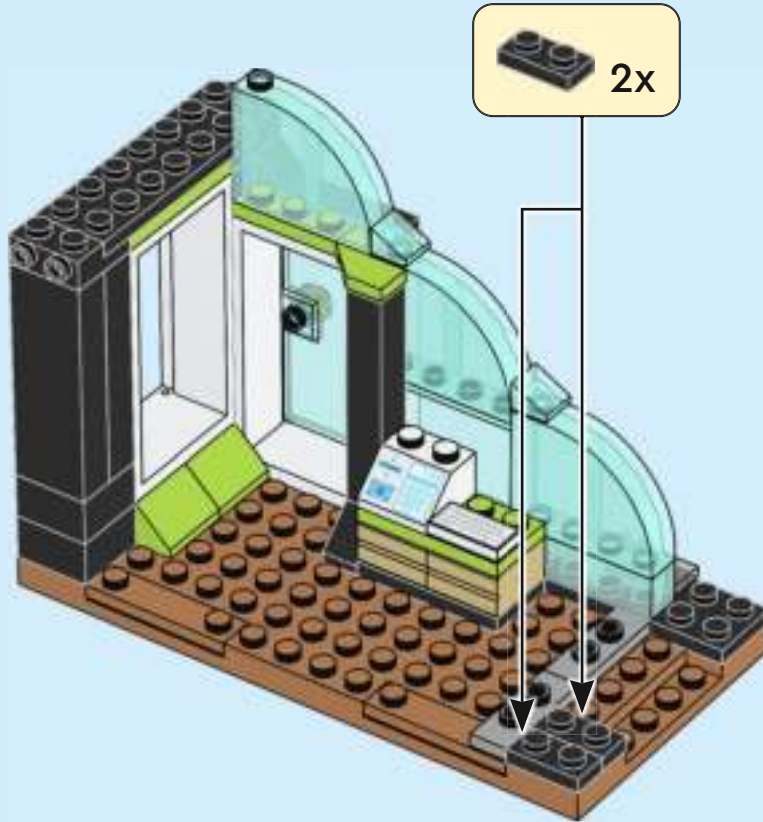



2x

78

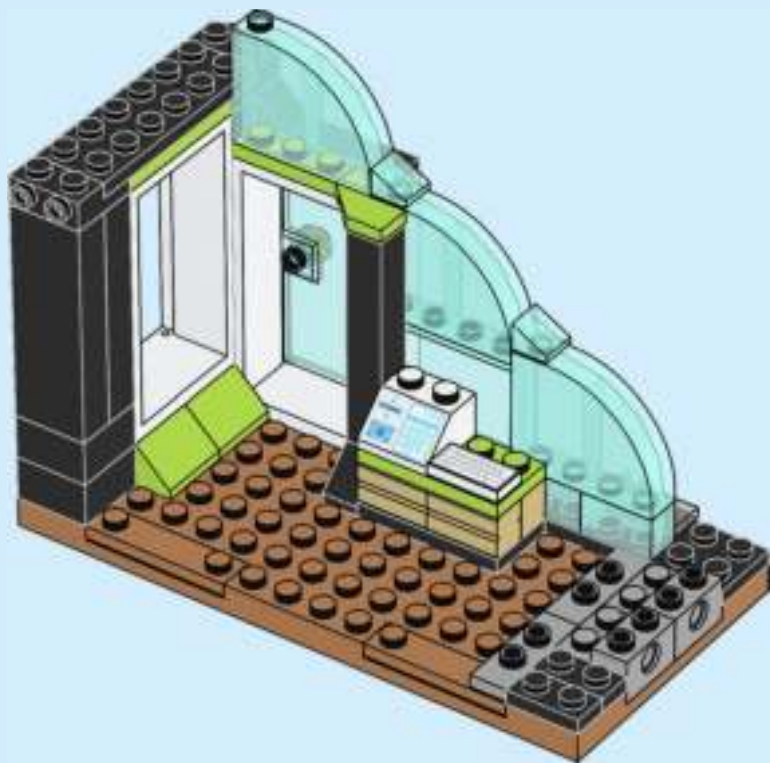



79

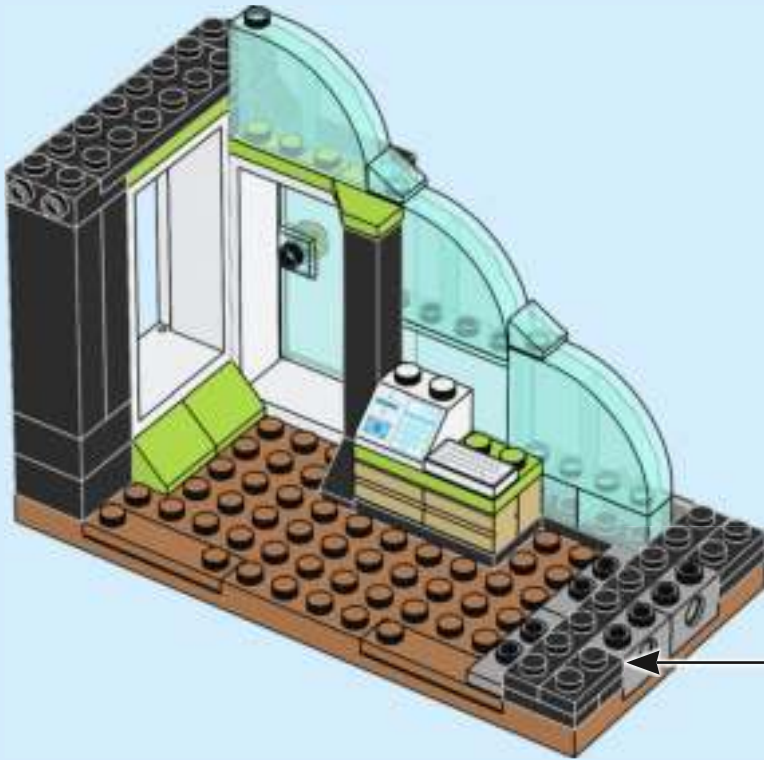



80

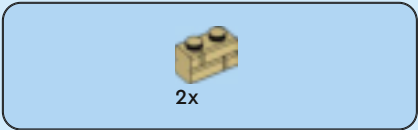

81

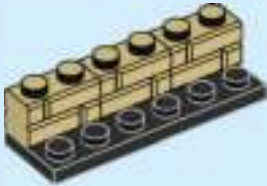





6x

82

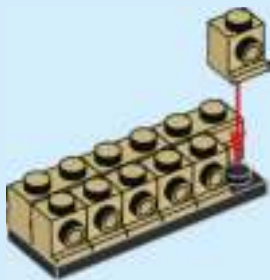

3x

83

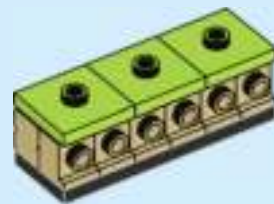



2x

84

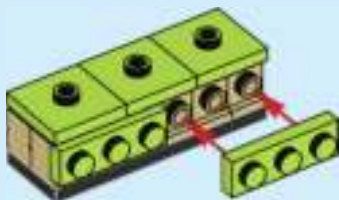

1x



2x

85

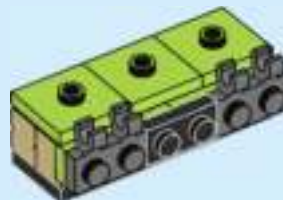

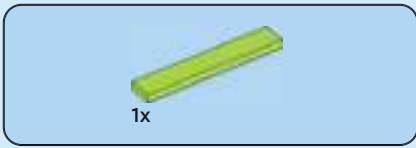

86

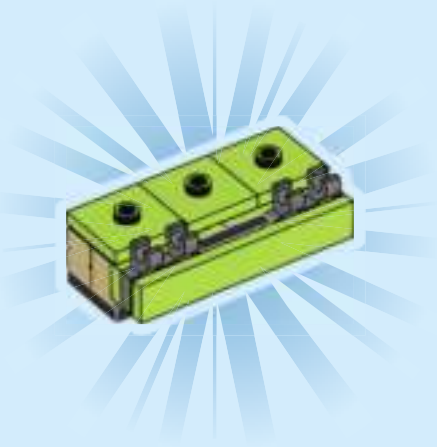

87

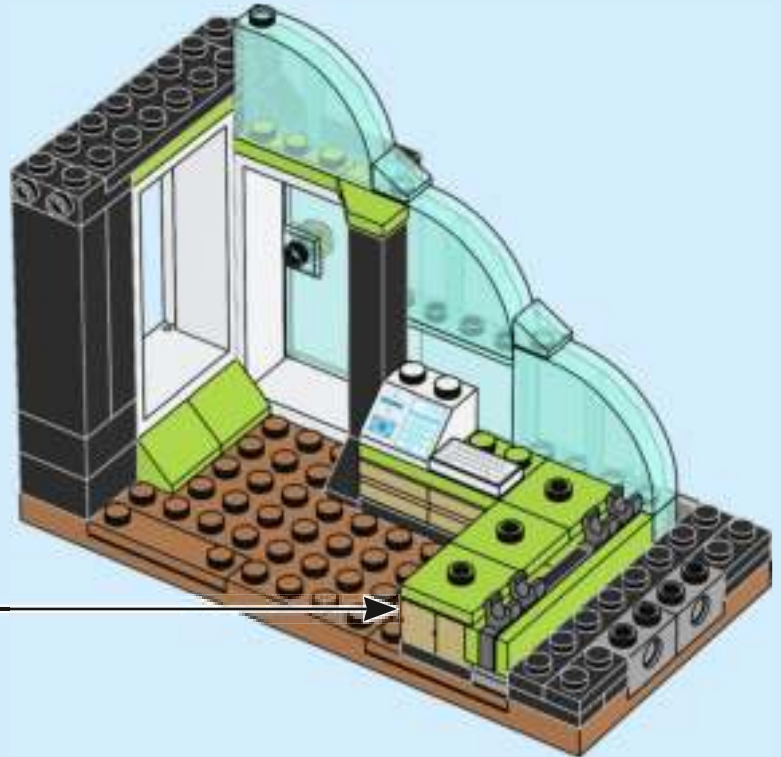



88

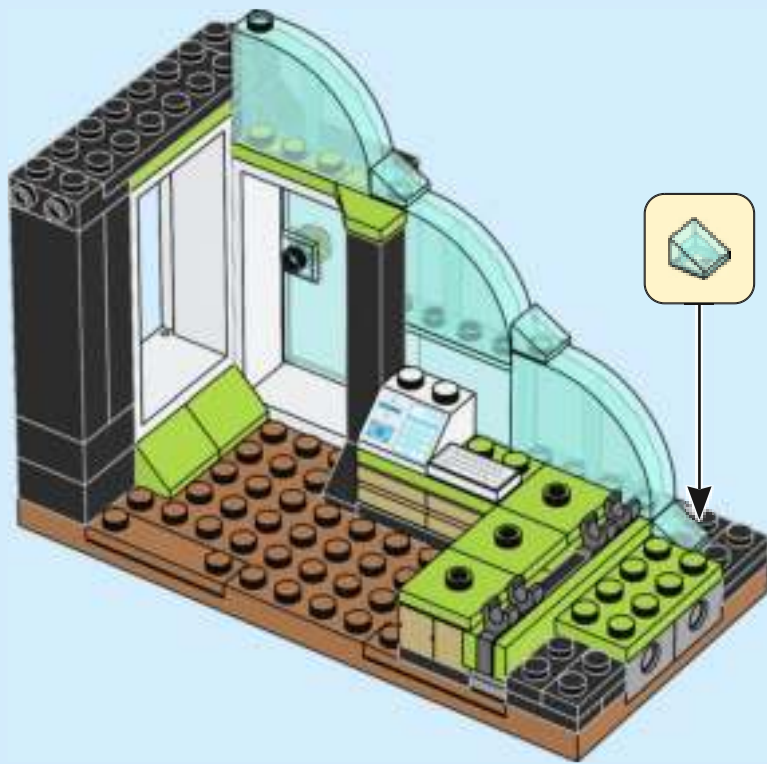



2x



1x

89

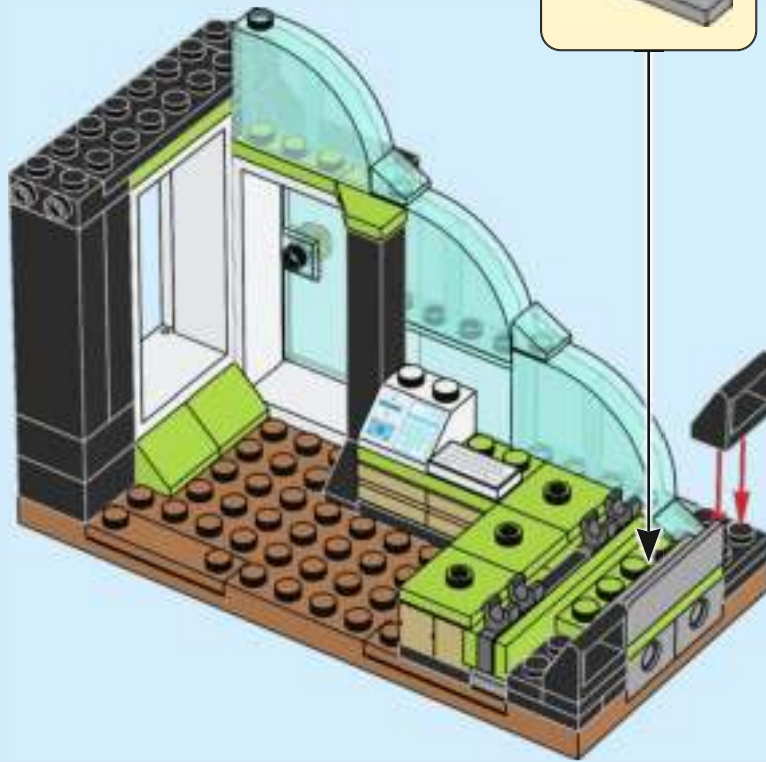
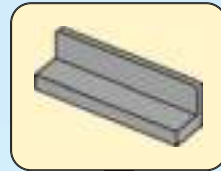

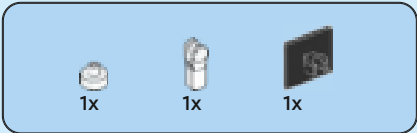

90

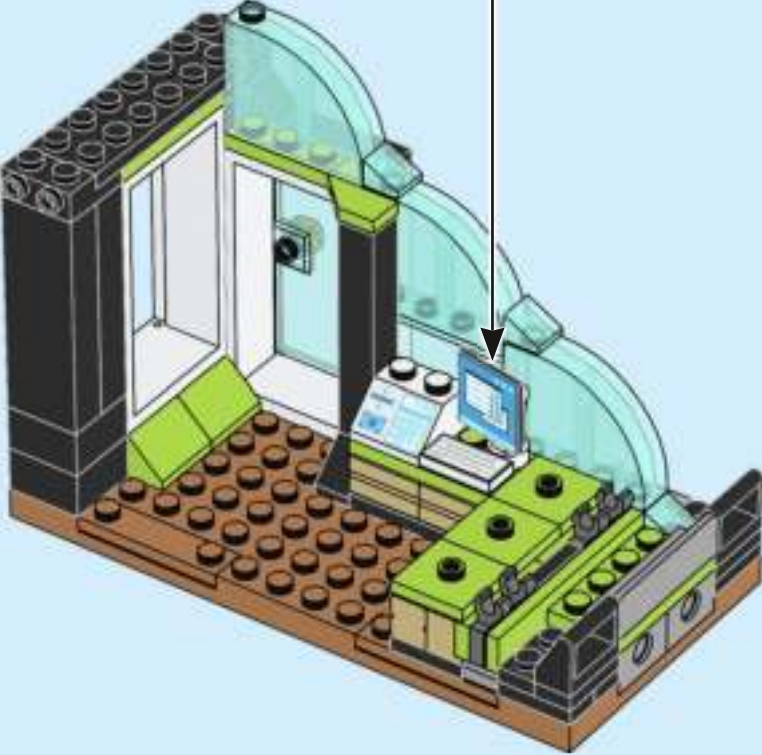
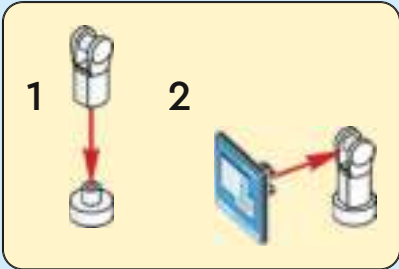



1x



1x

91

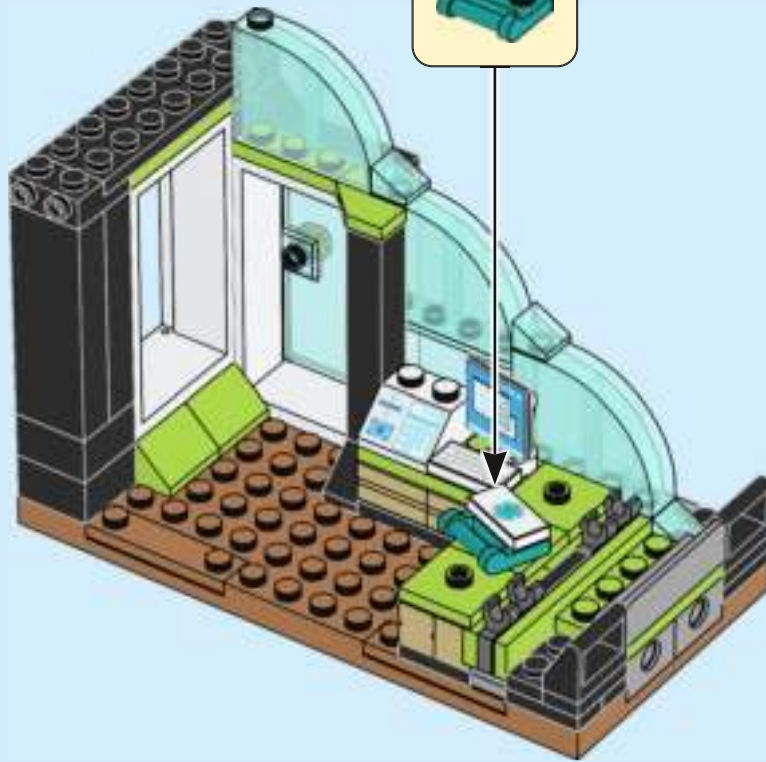



1x



1x



1x

# 92

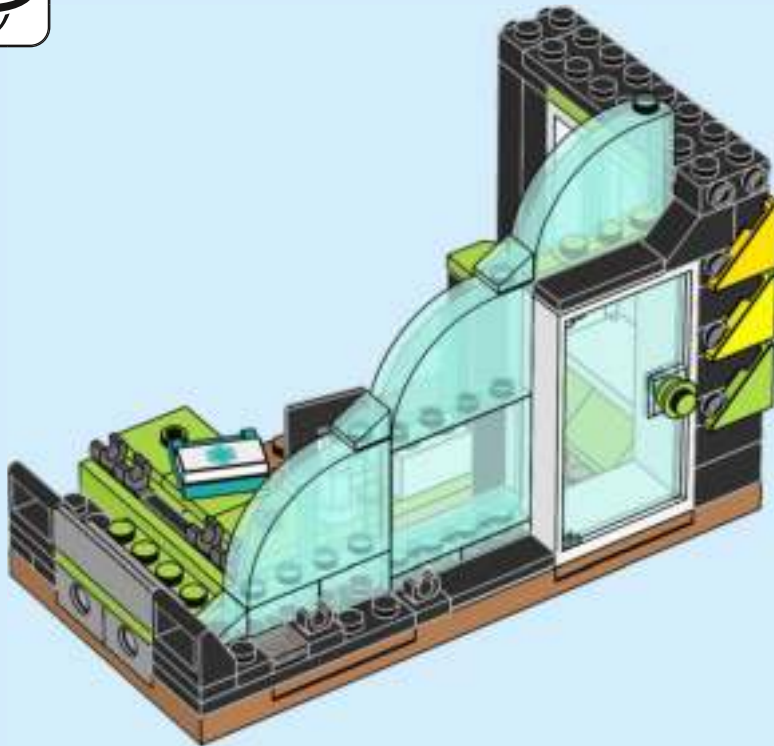





1x



3x

# 93

1

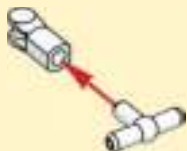

2

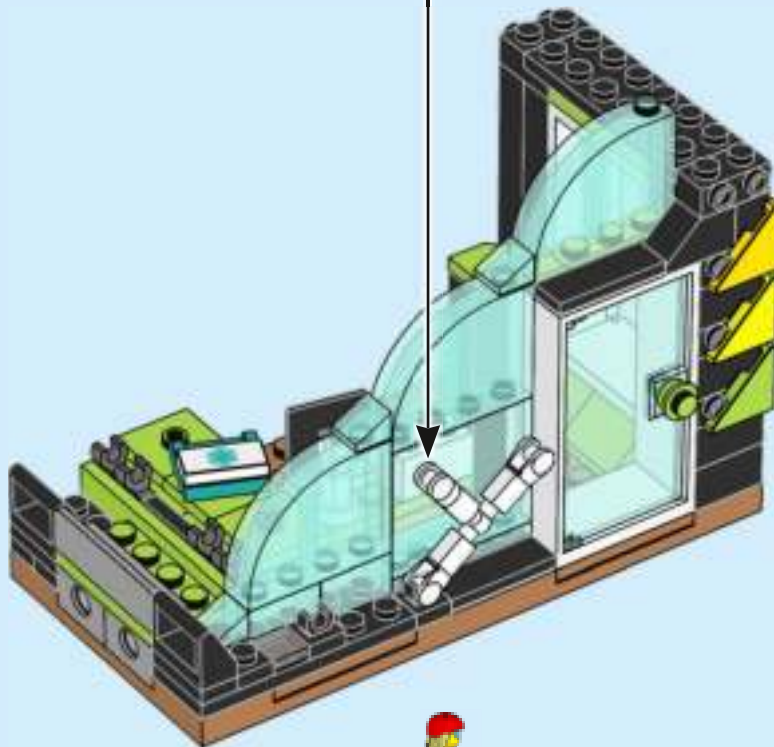



1x



1x



1x

94

1

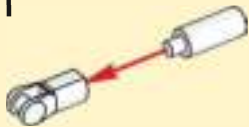

2

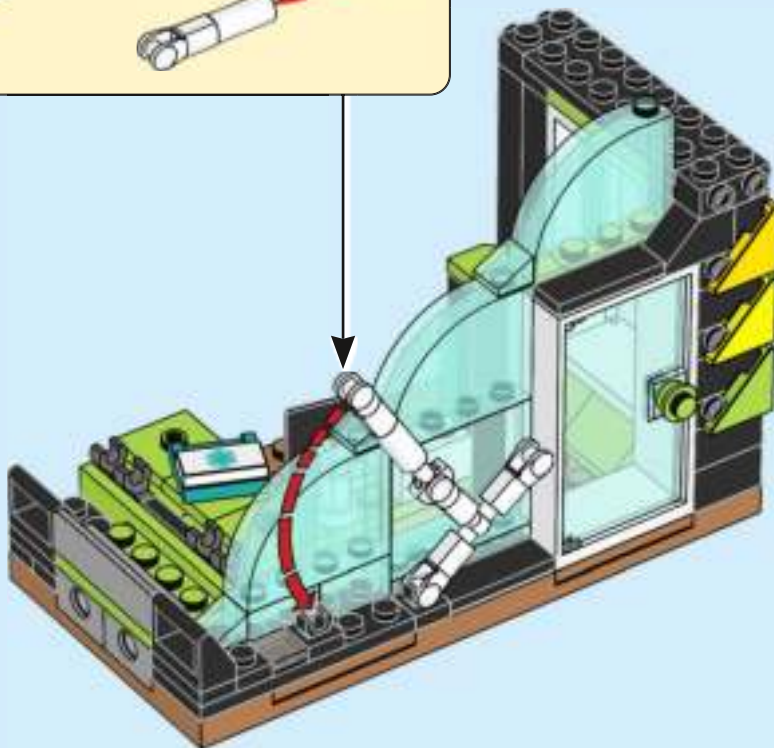
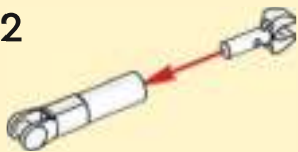

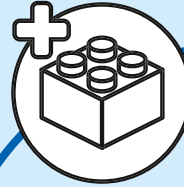



95

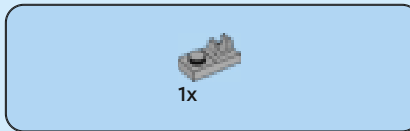
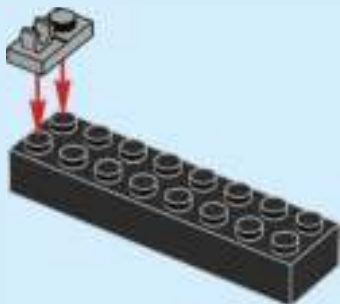

96

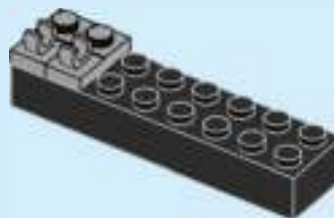



2x

97

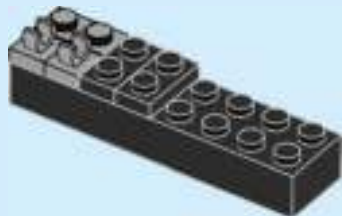

2x

98

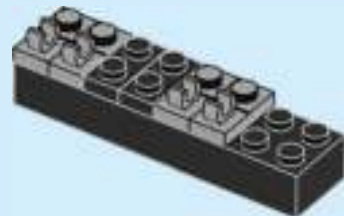



99

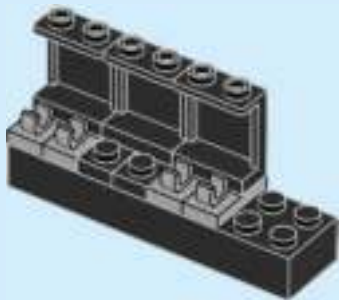

100

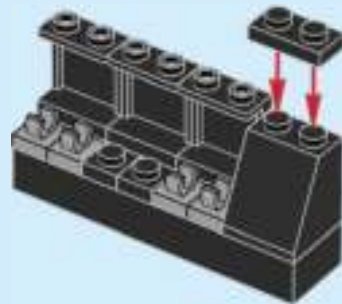

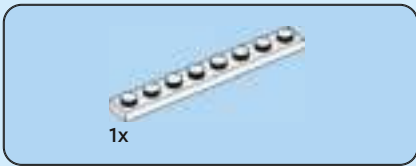

101

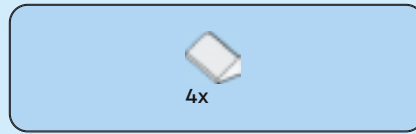

102

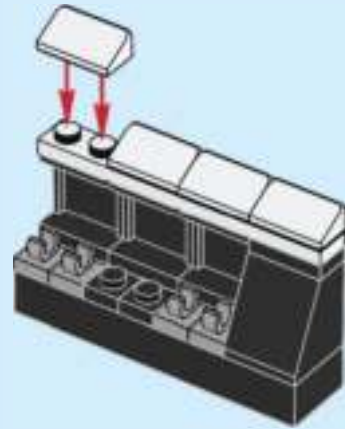

103

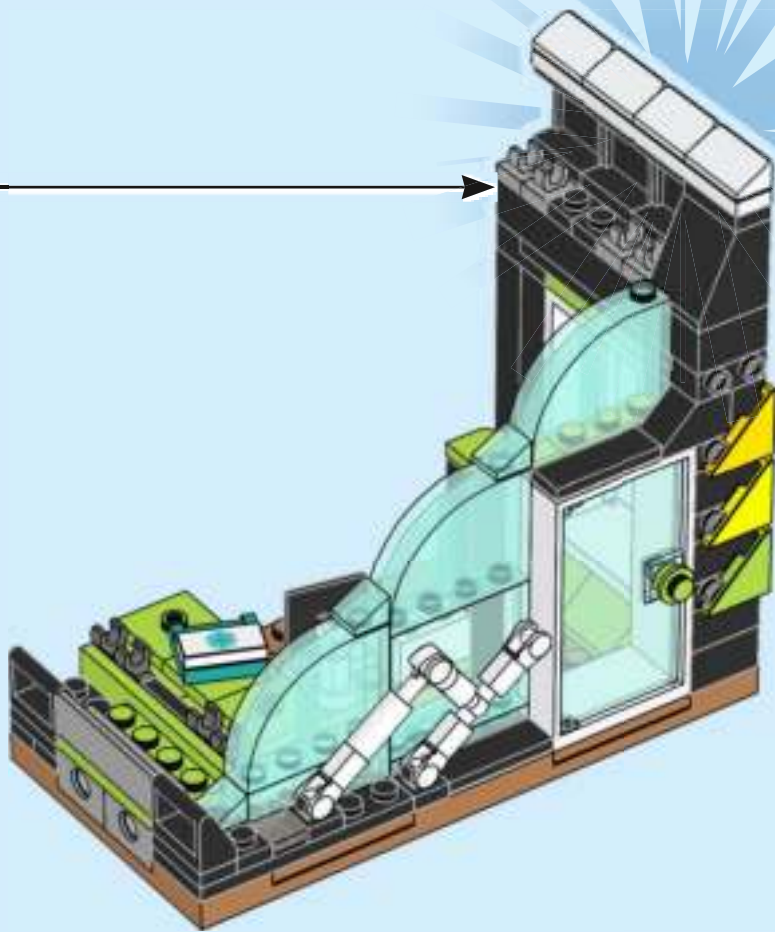





2x

104

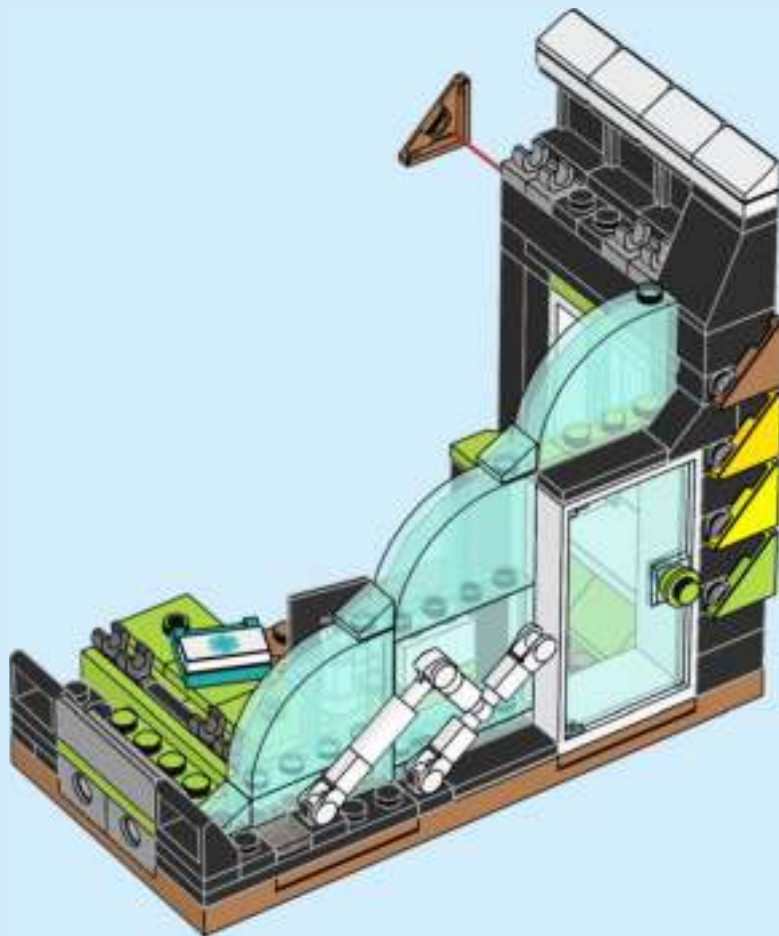

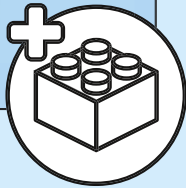
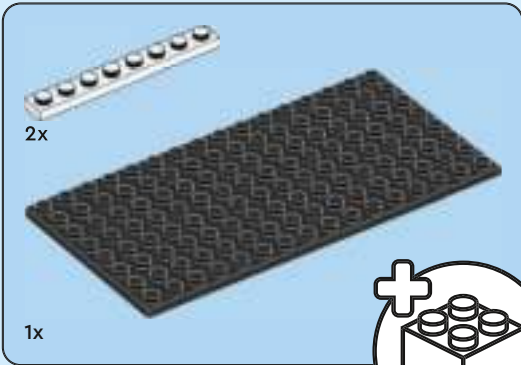

105

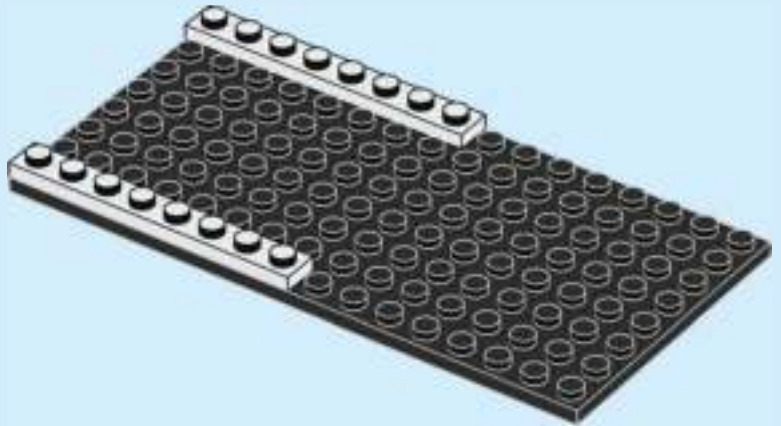



106

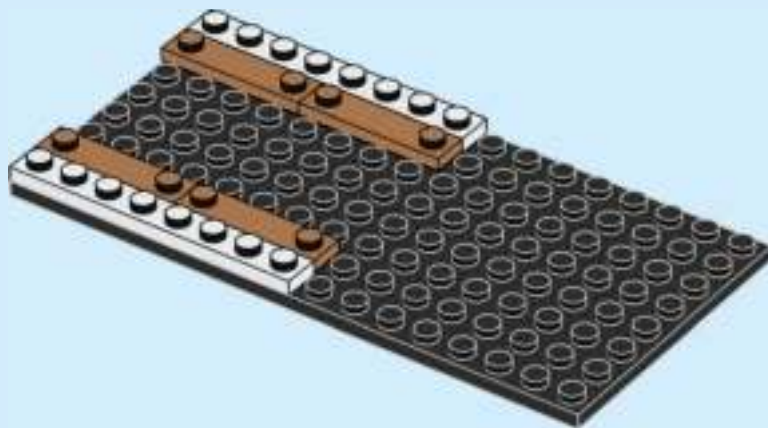

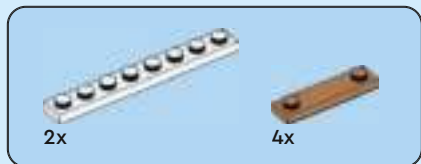

107

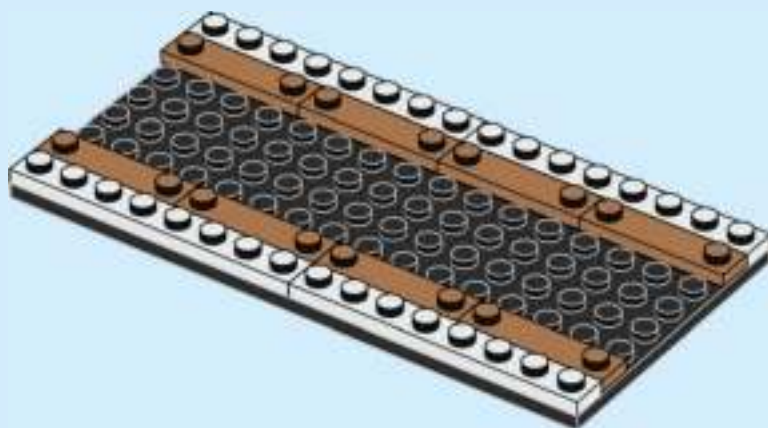



108

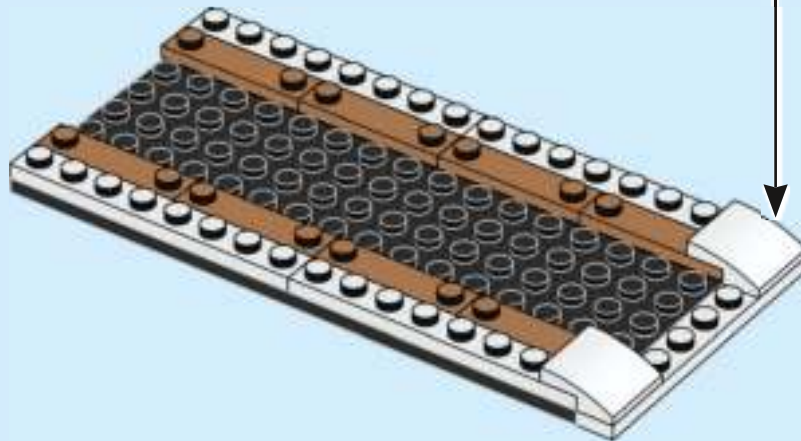
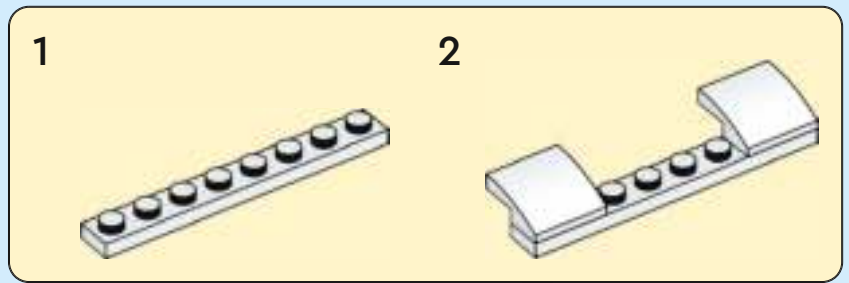



1x

109

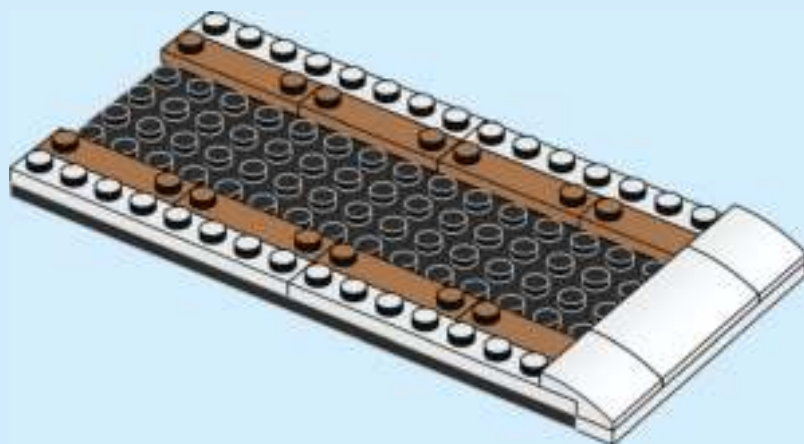

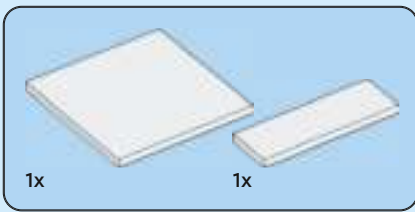

110

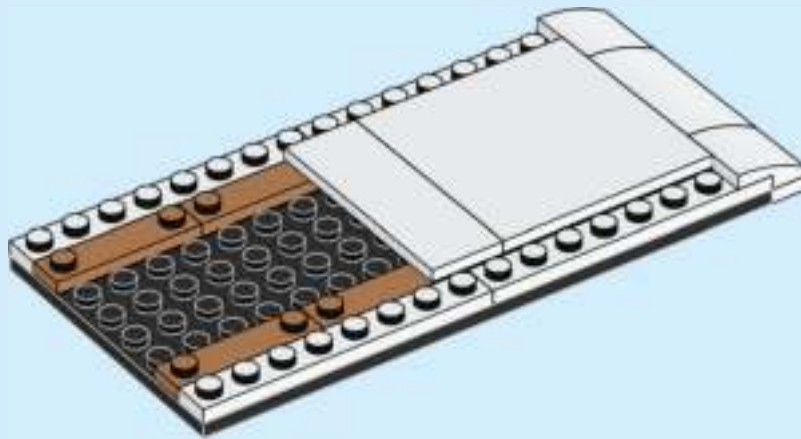



4x

111

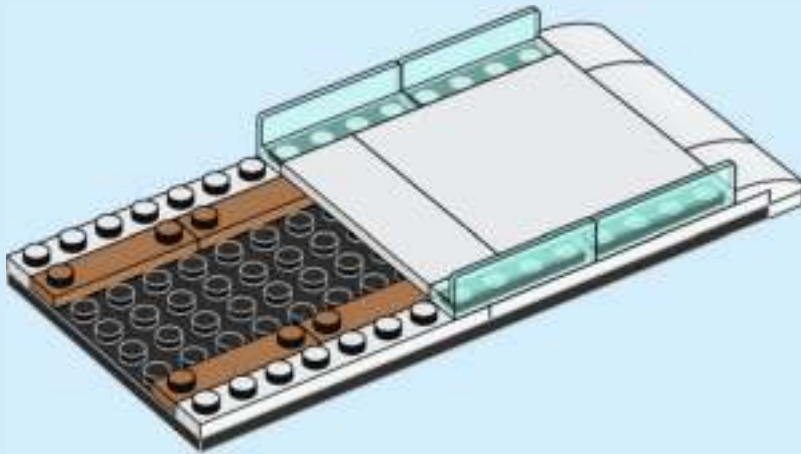





112

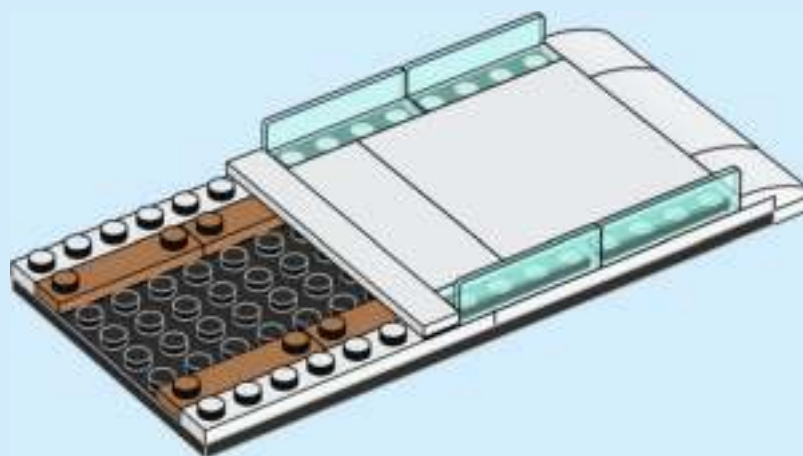



113

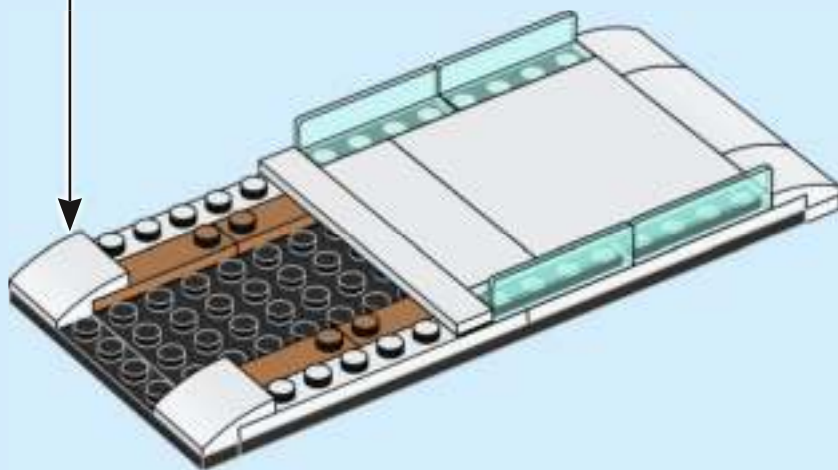
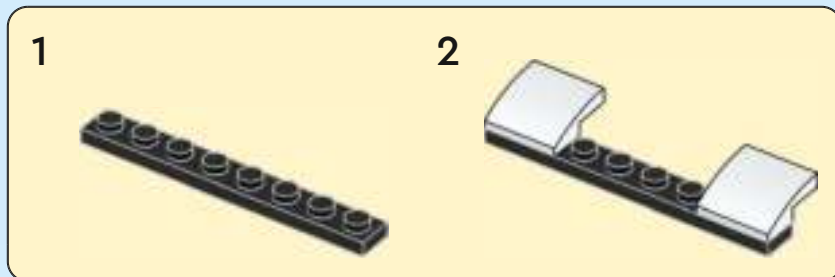



2x

# 114

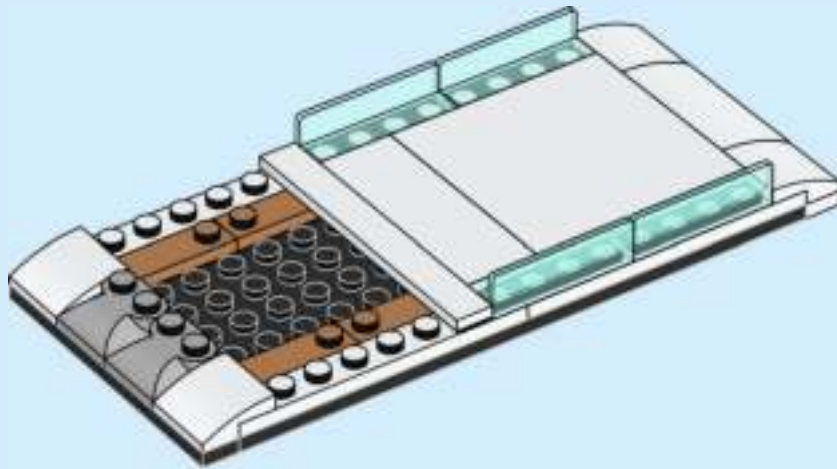

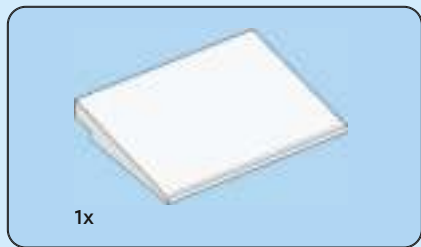

115

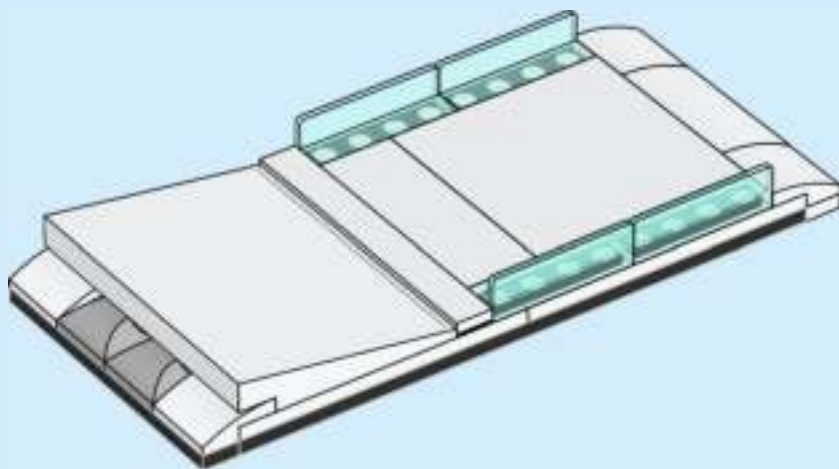

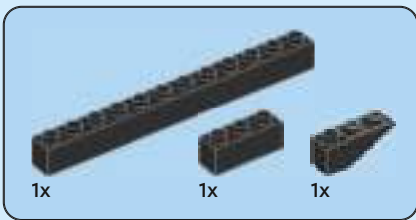

116

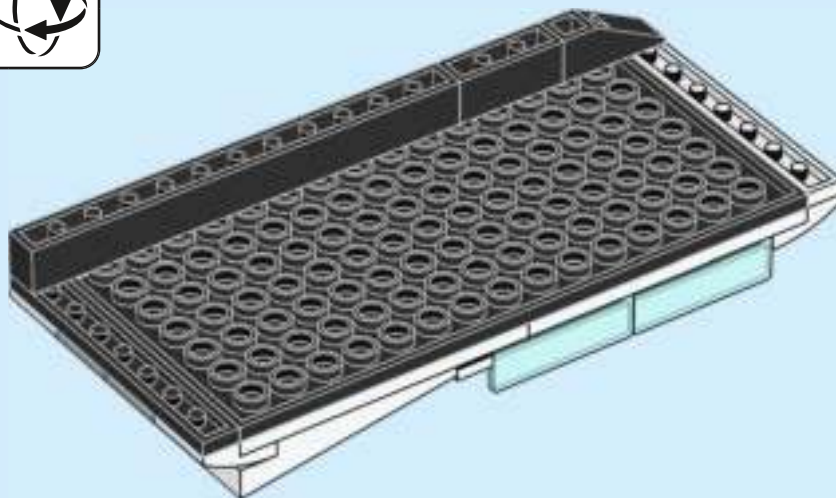



2x

117

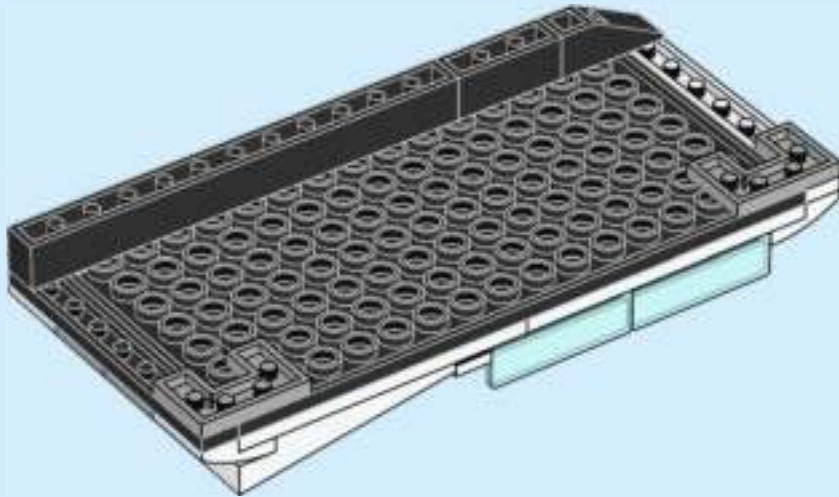



2x

118

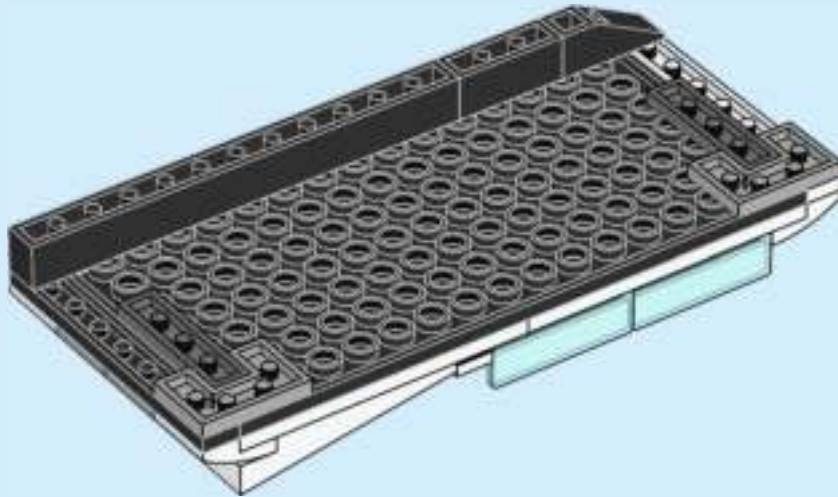



2x

119

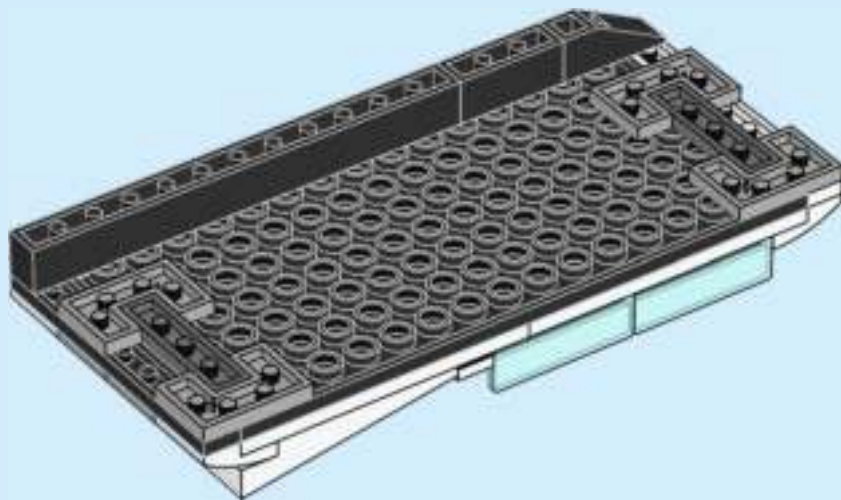





4x

120

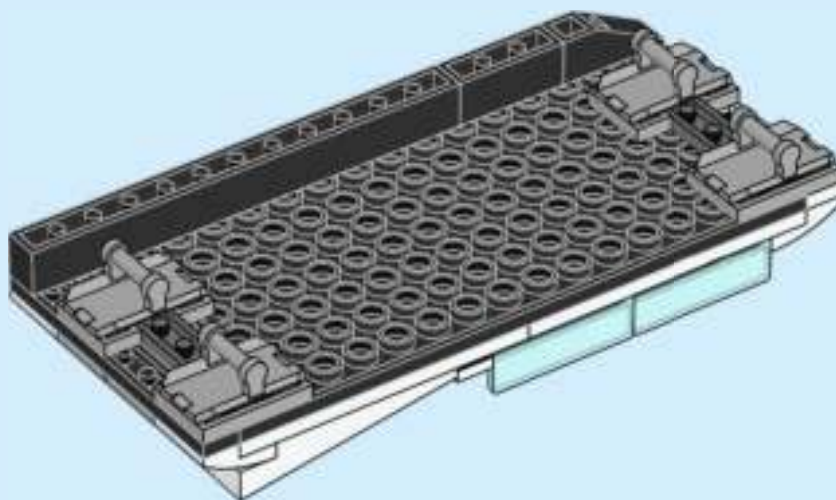

121

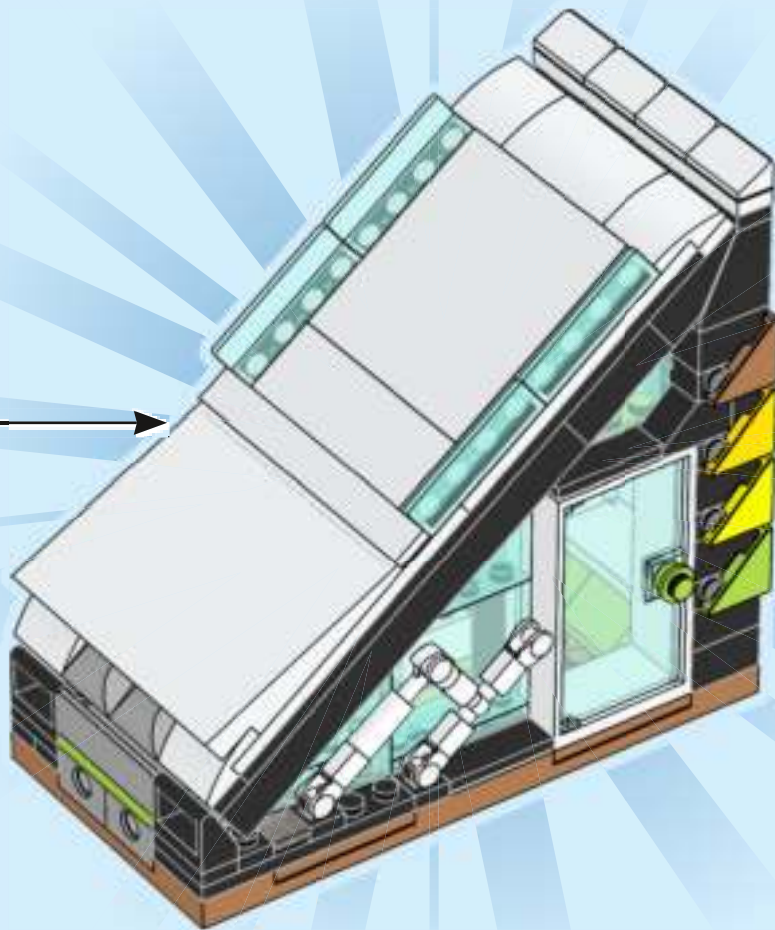

122

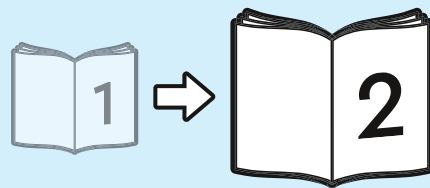
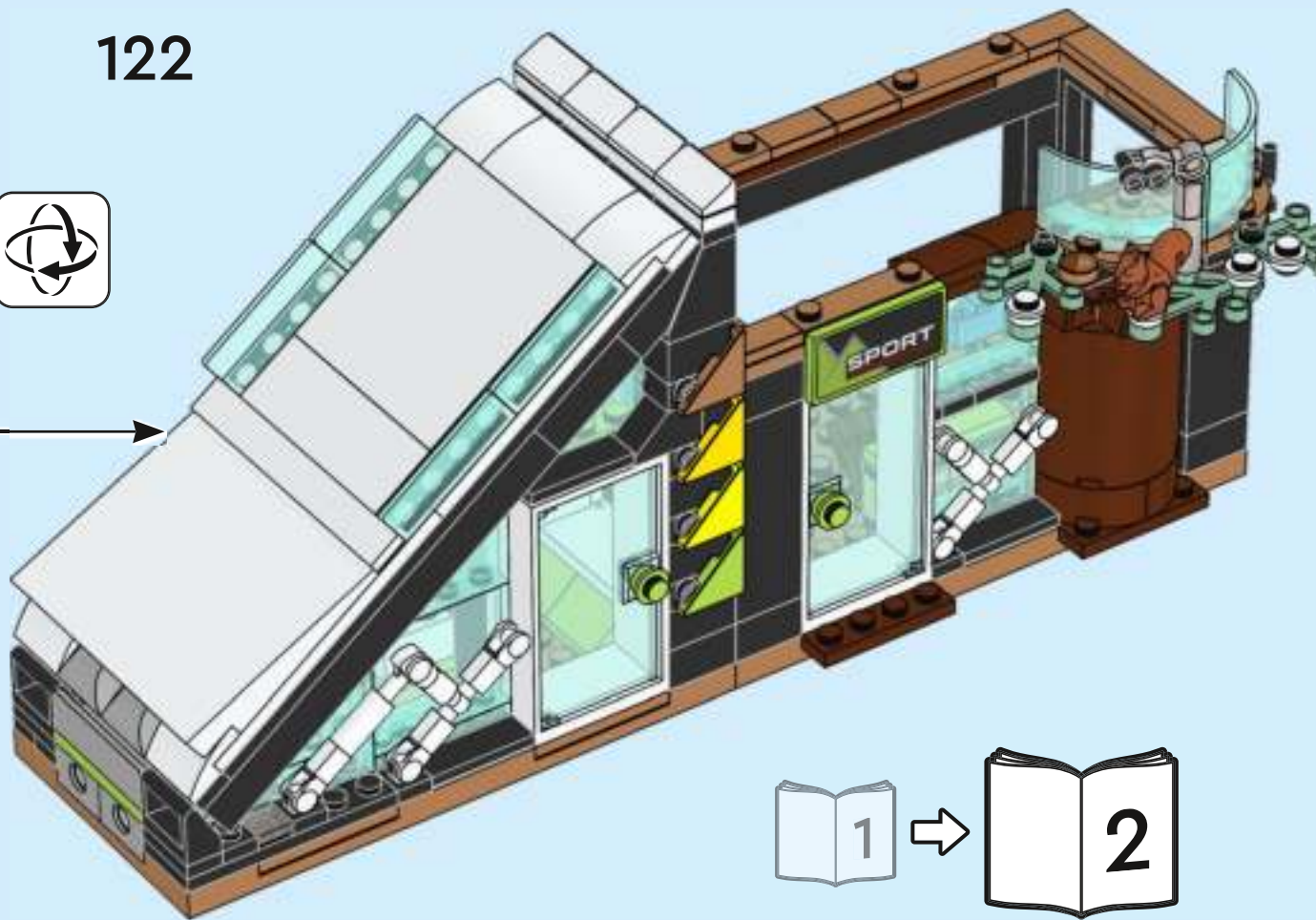

YOU COULD **WIN**



Scan this QR code or go to **LEGO.COM/PRODUCTFEEDBACK** and give us your short feedback about this LEGO® set for a chance to win a cool LEGO prize.

Terms and Conditions apply\*

**EN: YOU COULD WIN.** Terms and Conditions apply\* **DE: Du könntest GEWINNEN.** Es gelten die Teilnahmebedingungen\* **FR: Tu pourrais GAGNER.** Des conditions s'appliquent\* **IT: Potresti VINCERE tu.** Termini e condizioni sono applicabili\* **ES: Puedes GANAR.** Aplican términos y condiciones\* **PT: Poderá GANHAR.** Aplicam-se termos e condições\* **ZH: 轻松获奖. 条款和条件适用\*** **PL: Szansa na WYGRANĄ.** Obowiązują warunki korzystania\* **CS: Máte šanci VYHRÁT.** Platí všeobecné smluvní podmínky\* **SK: Máte šancu VYHRAŤ.** Platia všeobecné zmluvné podmienky\* **HU: TE IS NYERHETSZ.** Felhasználási feltételek érvényesek\* **RO: Ai putea CÂȘTIGA.** Se aplică termeni și condiții\* **BG: Можете да СПЕЧЕЛИТЕ.** Има определени правила и условия\* **LV: Tu vari LAIMĒT.** Ir spēkā noteikumi un nosacījumi.\* **ET: Sul on võimalus VÕITA.** Kehtivad tingimused\* **LT: Jūs galite LAIMĖTI.** Taikomos sąlygos\*

\*[LEGO.com/productfeedback-terms](https://www.lego.com/productfeedback-terms)