



## CONTENTS

1. SAFETY INFORMATION.....	2
2. SAFETY INSTRUCTIONS.....	4
3. INSTALLATION.....	6
4. PRODUCT DESCRIPTION.....	8
5. DAILY USE.....	9
6. HINTS AND TIPS.....	14
7. CARE AND CLEANING.....	17
8. TROUBLESHOOTING.....	17
9. TECHNICAL DATA.....	19
10. ENERGY EFFICIENCY.....	19

## WE'RE THINKING OF YOU

Thank you for purchasing an Electrolux appliance. You've chosen a product that brings with it decades of professional experience and innovation. Ingenious and stylish, it has been designed with you in mind. So whenever you use it, you can be safe in the knowledge that you'll get great results every time.

Welcome to Electrolux.

**Visit our website for:**



Get usage advice, brochures, trouble shooter, service information:  
**[www.electrolux.com/webselfservice](http://www.electrolux.com/webselfservice)**



Register your product for better service:  
**[www.registerelectrolux.com](http://www.registerelectrolux.com)**



Buy Accessories, Consumables and Original spare parts for your appliance:  
**[www.electrolux.com/shop](http://www.electrolux.com/shop)**

## CUSTOMER CARE AND SERVICE

Always use original spare parts.

When contacting our Authorised Service Centre, ensure that you have the following data available: Model, PNC, Serial Number.

The information can be found on the rating plate.

 Warning / Caution-Safety information

 General information and tips

 Environmental information

Subject to change without notice.

### 1. SAFETY INFORMATION

Before the installation and use of the appliance, carefully read the supplied instructions. The manufacturer is not responsible for any injuries or damages that are the result of incorrect installation or usage. Always keep the

instructions in a safe and accessible location for future reference.

### 1.1 Children and vulnerable people safety

- This appliance can be used by children aged from 8 years and above and persons with reduced physical, sensory or mental capabilities or lack of experience and knowledge if they have been given supervision or instruction concerning the use of the appliance in a safe way and understand the hazards involved.
- Children between 3 and 8 years of age and persons with very extensive and complex disabilities shall be kept away unless continuously supervised.
- Children of less than 3 years of age should be kept away unless continuously supervised.
- Do not let children play with the appliance.
- Keep all packaging away from children and dispose of it appropriately.
- Keep children and pets away from the appliance when it operates or when it cools down. Accessible parts are hot.
- If the appliance has a child safety device, it should be activated.
- Children shall not carry out cleaning and user maintenance of the appliance without supervision.

### 1.2 General Safety

- **WARNING:** The appliance and its accessible parts become hot during use. Care should be taken to avoid touching heating elements.
- Do not operate the appliance by means of an external timer or separate remote-control system.
- **WARNING:** Unattended cooking on a hob with fat or oil can be dangerous and may result in fire.
- **NEVER** try to extinguish a fire with water, but switch off the appliance and then cover flame e.g. with a lid or a fire blanket.

- **CAUTION:** The cooking process has to be supervised. A short term cooking process has to be supervised continuously.
- **WARNING:** Danger of fire: Do not store items on the cooking surfaces.
- Metallic objects such as knives, forks, spoons and lids should not be placed on the hob surface since they can get hot.
- Do not use a steam cleaner to clean the appliance.
- After use, switch off the hob element by its control and do not rely on the pan detector.
- If the glass ceramic surface / glass surface is cracked, switch off the appliance and unplug it from the mains. In case the appliance is connected to the mains directly using junction box, remove the fuse to disconnect the appliance from power supply. In either case contact the Authorised Service Centre.
- If the supply cord is damaged, it must be replaced by the manufacturer, an authorized Service or similarly qualified persons in order to avoid a hazard.
- **WARNING:** Use only hob guards designed by the manufacturer of the cooking appliance or indicated by the manufacturer of the appliance in the instructions for use as suitable or hob guards incorporated in the appliance. The use of inappropriate guards can cause accidents.

## 2. SAFETY INSTRUCTIONS

### 2.1 Installation



**WARNING!**

Only a qualified person must install this appliance.



**WARNING!**

Risk of injury or damage to the appliance.

- Remove all the packaging.
- Do not install or use a damaged appliance.
- Follow the installation instructions supplied with the appliance.
- Keep the minimum distance from other appliances and units.
- Always take care when moving the appliance as it is heavy. Always use safety gloves and enclosed footwear.
- Seal the cut surfaces with a sealant to prevent moisture to cause swelling.
- Protect the bottom of the appliance from steam and moisture.
- Do not install the appliance adjacent to a door or under a window. This prevents hot cookware falling from the

appliance when the door or the window is opened.

- Each appliance has cooling fans on the bottom.
- If the appliance is installed above a drawer:
  - Do not store any small pieces or sheets of paper that could be pulled in, as they can damage the cooling fans or impair the cooling system.
  - Keep a distance of minimum 2 cm between the bottom of the appliance and parts stored in the drawer.

## 2.2 Electrical Connection



### **WARNING!**

Risk of fire and electric shock.

- All electrical connections should be made by a qualified electrician.
- The appliance must be earthed.
- Before carrying out any operation make sure that the appliance is disconnected from the power supply.
- Make sure that the parameters on the rating plate are compatible with the electrical ratings of the mains power supply.
- Make sure the appliance is installed correctly. Loose and incorrect electricity mains cable or plug (if applicable) can make the terminal become too hot.
- Use the correct electricity mains cable.
- Do not let the electricity mains cable tangle.
- Make sure that a shock protection is installed.
- Use the strain relief clamp on the cable.
- Make sure the mains cable or plug (if applicable) does not touch the hot appliance or hot cookware, when you connect the appliance to the near sockets.
- Do not use multi-plug adapters and extension cables.
- Make sure not to cause damage to the mains plug (if applicable) or to the mains cable. Contact our Authorised

Service Centre or an electrician to change a damaged mains cable.

- The shock protection of live and insulated parts must be fastened in such a way that it cannot be removed without tools.
- Connect the mains plug to the mains socket only at the end of the installation. Make sure that there is access to the mains plug after the installation.
- If the mains socket is loose, do not connect the mains plug.
- Do not pull the mains cable to disconnect the appliance. Always pull the mains plug.
- Use only correct isolation devices: line protecting cut-outs, fuses (screw type fuses removed from the holder), earth leakage trips and contactors.
- The electrical installation must have an isolation device which lets you disconnect the appliance from the mains at all poles. The isolation device must have a contact opening width of minimum 3 mm.

## 2.3 Use



### **WARNING!**

Risk of injury, burns and electric shock.

- Remove all the packaging, labelling and protective film (if applicable) before first use.
- Use this appliance in a household environment.
- Do not change the specification of this appliance.
- Make sure that the ventilation openings are not blocked.
- Do not let the appliance stay unattended during operation.
- Set the cooking zone to “off” after each use.
- Do not rely on the pan detector.
- Do not put cutlery or saucepan lids on the cooking zones. They can become hot.
- Do not operate the appliance with wet hands or when it has contact with water.
- Do not use the appliance as a work surface or as a storage surface.

- If the surface of the appliance is cracked, disconnect immediately the appliance from the power supply. This to prevent an electrical shock.
- Users with a pacemaker must keep a distance of minimum 30 cm from the induction cooking zones when the appliance is in operation.
- When you place food into hot oil, it may splash.

**WARNING!**

Risk of fire and explosion

- Fats and oil when heated can release flammable vapours. Keep flames or heated objects away from fats and oils when you cook with them.
- The vapours that very hot oil releases can cause spontaneous combustion.
- Used oil, that can contain food remnants, can cause fire at a lower temperature than oil used for the first time.
- Do not put flammable products or items that are wet with flammable products in, near or on the appliance.

**WARNING!**

Risk of damage to the appliance.

- Do not keep hot cookware on the control panel.
- Do not put a hot pan cover on the glass surface of the hob.
- Do not let cookware to boil dry.
- Be careful not to let objects or cookware fall on the appliance. The surface can be damaged.
- Do not activate the cooking zones with empty cookware or without cookware.
- Do not put aluminium foil on the appliance.
- Cookware made of cast iron, aluminium or with a damaged bottom

## 3. INSTALLATION

**WARNING!**

Refer to Safety chapters.

can cause scratches on the glass / glass ceramic. Always lift these objects up when you have to move them on the cooking surface.

- This appliance is for cooking purposes only. It must not be used for other purposes, for example room heating.

### 2.4 Care and cleaning

- Clean the appliance regularly to prevent the deterioration of the surface material.
- Deactivate the appliance and let it cool down before you clean it.
- Disconnect the appliance from the electrical supply before maintenance.
- Do not use water spray and steam to clean the appliance.
- Clean the appliance with a moist soft cloth. Only use neutral detergents. Do not use any abrasive products, abrasive cleaning pads, solvents or metal objects.

### 2.5 Service

- To repair the appliance contact an Authorised Service Centre.
- Use original spare parts only.

### 2.6 Disposal

**WARNING!**

Risk of injury or suffocation.

- Contact your municipal authority for information on how to discard the appliance correctly.
- Disconnect the appliance from the mains supply.
- Cut off the mains electrical cable close to the appliance and dispose of it.

### 3.1 Before the installation

Before you install the hob, write down the information below from the rating plate. The rating plate is on the bottom of the hob.

Serial number .....

### 3.2 Built-in hobs

Only use the built-in hobs after you assemble the hob into correct built-in units and work surfaces that align to the standards.

### 3.3 Connection cable

- The hob is supplied with a connection cable.
- To replace the damaged mains cable, use the cable type: H05V2V2-F which withstands a temperature of 90°C or higher. Speak to your local Service Centre.

### 3.4 Assembly

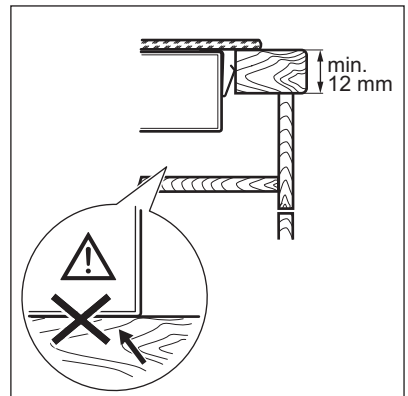
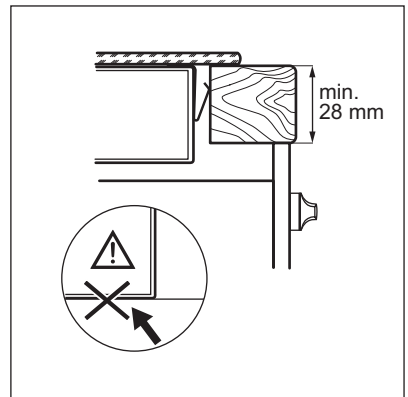
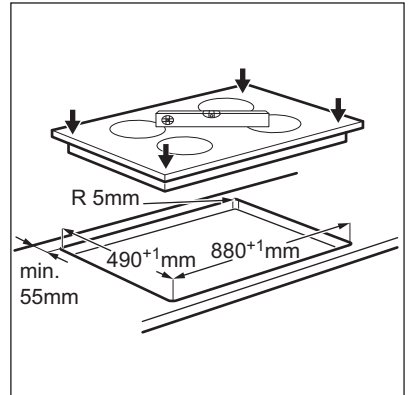
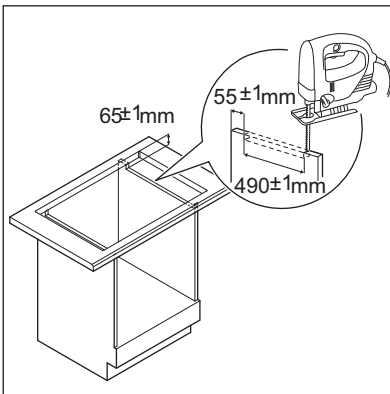
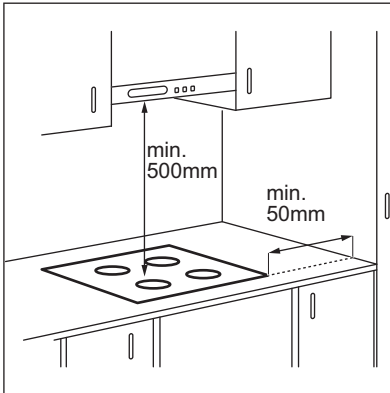

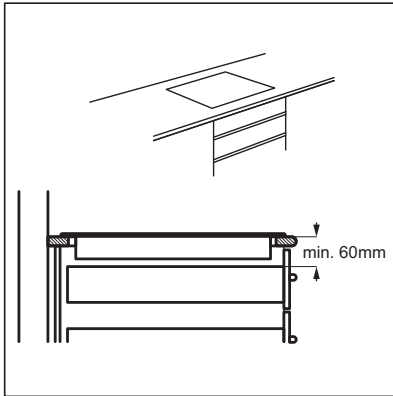

**i** If the appliance is installed above a drawer, the hob ventilation can warm up the items stored in the drawer during the cooking process.

## 4. PRODUCT DESCRIPTION

### 4.1 Cooking surface layout

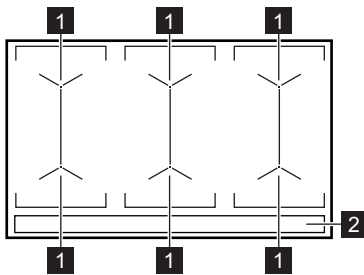





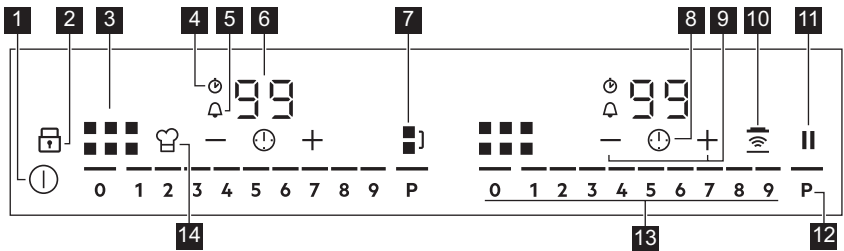

- 1** Induction cooking surface
- 2** Control panel

### 4.2 Control panel layout



- 1** To activate and deactivate the hob.
- 2** To activate and deactivate the Lock or the Child Safety Device.
- 3** The cooking zone indicator.
- 4** CountUp Timer indicator.
- 5** Count Down Timer indicator.





- 6** Timer display: **00 - 99** minutes.
- 7**  To activate and deactivate the Bridge function.
- 8**  To set the timer function.
- 9**  To increase and decrease the time.
- 10**  To activate and deactivate the Hob²Hood function.
- 11**  To activate and deactivate the Pause function.
- 12**  To activate the PowerBoost function.
- 13** Control bar to set a heat setting **0 - 9**.
- 14**  To activate and deactivate the PowerSlide function.

### 4.3 OptiHeat Control (3 step Residual heat indicator)



#### **WARNING!**

 /  /  The indicators show the level of the residual heat for the cooking zones you are currently using. The indicators may also come on for the neighbouring cooking zones even if you are not using them.

The induction cooking zones produce the heat necessary for the cooking process directly in the bottom of the cookware. The glass ceramic is heated by the heat of the cookware.

When the hob is deactivated, the indicators are still visible. When the hob is cold enough, they disappear.

## 5. DAILY USE



#### **WARNING!**

Refer to Safety chapters.

### 5.1 Activating and deactivating

Touch  for 1 second to activate or deactivate the hob.

The control bars come on after you activate the hob and go off after you deactivate the hob.

When the hob is deactivated you can only see .

### 5.2 Automatic Switch Off

**The function deactivates the hob automatically if:**

- you do not place any cookware on the hob for 50 seconds,
- you do not set the heat setting for 50 seconds after you place the cookware,

- you spill something or put something on the control panel for more than 10 seconds (a pan, a cloth). When you hear the acoustic signal, the hob deactivates. Remove the object or clean the control panel.
- the hob gets too hot (e.g. when a saucepan boils dry). Let the cooking zone cool down before you use the hob again.
- you do not deactivate a cooking zone or change the heat setting. After some time, the hob deactivates.

**The relation between the heat setting and the time after which the hob deactivates:**

Heat setting	The hob deactivates after
1 - 2	6 hours
3 - 4	5 hours

Heat setting	The hob deactivates after
5	4 hours
6 - 9	1.5 hours

### 5.3 Using the cooking zones



#### CAUTION!

Do not place hot cookware on the control panel. There is a risk of damage to the electronic parts.

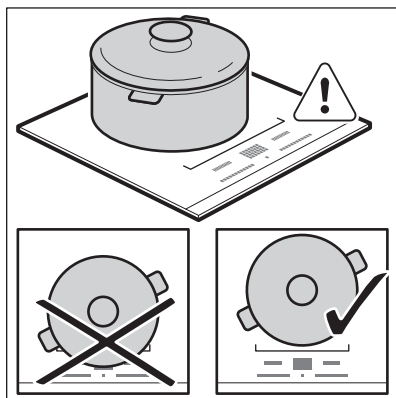

Place the cookware in the centre of the selected zone. Induction cooking zones adapt to the dimension of the bottom of the cookware automatically.

When you place the cookware in the correct position, the hob recognizes it and the appropriate control bar comes on. A red cooking zone indicator appears above the control bar and indicates the position of the pot.

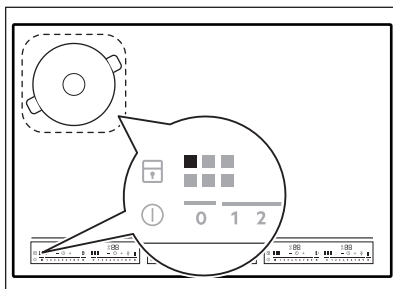

Each square on the control panel represents one cooking zone on the induction cooking surface. Zone indicators show which cooking zone is controlled by the appropriate control bar.

### 5.4 The heat setting

Touch the control bar at the desired heat setting or move your finger along the control bar to set or change the heat setting for a cooking zone.

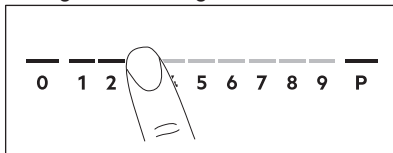



Once you place a pot on the zone and set the heat setting it remains the same for 2 minutes after you remove the pot. The control bar and the cooking zone indicator blink for 2 minutes. If you place the pot on the cooking zone again within this time the heat setting reactivates, otherwise, the cooking zone deactivates.

### 5.5 Bridge function

This function connects two cooking zones and they operate as one. You can use the function with large cookware.

1. Place the cookware on two cooking zones. The cookware must cover the centres of both zones.

 turns white.

2. Press  to activate the function.
3. Set the heat setting.

The cookware must cover the centres of both zones but not go beyond the area marking.

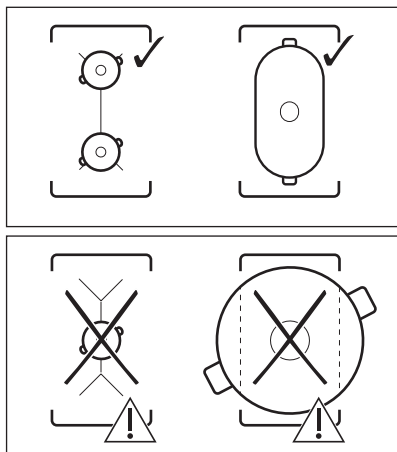

To deactivate the function, touch **P**. The cooking zones operate independently.

## 5.6 PowerBoost

This function activates more power for the appropriate induction cooking zone, and it depends on the cookware size. The function can be activated only for a limited period of time.

Touch **P** to activate the function for the cooking zone. The symbol turns red. The function deactivates automatically.

**i** For maximum duration values, refer to "Technical data".





## 5.7 Timer

### Count Down Timer



Use this function to specify how long a cooking zone should operate during a single cooking session.





Set the heat setting for the appropriate cooking zone and then set the function.

1. Touch  to activate the function or change the time.





The timer digits **00** and the indicators  and  come on the display.  turns red, and  turns white.

If the timer is not set, all indicators disappear after 4 seconds.

2. Touch  or  to set the time (00 - 99 minutes).

After 3 seconds, the timer starts to count down automatically. The indicators , , and  disappear.  stays red.

When the time comes to an end, a signal sounds and **00** flashes. To stop the signal, touch .

To deactivate the function: touch . The indicators  and  come on. Use  or  to set **00** on the display. Alternatively, set the heat level to **0**. As a result, a signal sounds and the timer is cancelled.

### CountUp Timer (The count up timer)

You can use this function to monitor how long a cooking zone operates.

Touch  twice to activate the function.

The indicator  turns red, the timer starts to count up automatically.



To deactivate the function: touch .







When the indicators light up, touch .

### Minute Minder

You can use this function when the hob is activated but the cooking zones do not operate.





To see the control panel, place a pot on a cooking zone.

1. Touch , until the indicator  turns red, to activate the function.

2. Touch  or  to set the time. The function starts automatically after 4 seconds. The indicators , , and  disappear.  stays red.

When you set the function, you can remove the pot.

When the time comes to an end, a signal sounds and **00** flashes. Touch  to stop the signal.



To deactivate the function: touch . The indicators  and  light up. Use  or  to set **00** on the display.

 The function has no effect on the operation of the cooking zones.

## 5.8 Pause

This function sets all cooking zones that operate to the lowest heat setting.

When the function operates, all other symbols on the control panels are locked.

When the function is active,  and  symbols can be used.

The function does not stop the timer functions.

Touch  to activate the function. The symbol turns red. The heat setting is lowered to 1.

To deactivate the function, touch . The symbol turns white. The previous heat setting comes on.

## 5.9 Lock

You can lock the control panel while the hob operates. It prevents an accidental change of the heat setting.

Set the heat setting first.

Touch  to activate the function. The symbol turns red and blinks.

To deactivate the function, touch . The symbol turns white.

 When you deactivate the hob, you also deactivate this function.





## 5.10 Child Safety Device

This function prevents an accidental operation of the hob.

Activate the hob first and do not set the heat setting.

Touch  until it turns red to activate the function.

The control bar disappears.

**To activate the function for only one cooking time:** Activate the hob with .  comes on. Touch  until it turns white. The control bar appears. Set the heat setting within 50 seconds. You can operate the hob. When you deactivate the hob with  the function is still active.

To deactivate the function completely, activate the hob and do not set the heat setting. Touch  until it turns white. The control bar appears. Deactivate the hob.

## 5.11 PowerSlide

This function allows you to adjust the temperature by moving the cookware to a different position on the induction cooking surface.

This function automatically divides all cooking zones into three areas with different heat settings. The hob detects the position of the cookware and adjusts the pre-set power level accordingly.

- The zone indicator shows both zones in a bridge even if only one of the zones is used.
- You may adjust the heat setting manually only if at least one of the zones is activated automatically.
- You can change the heat settings for each position separately. When you deactivate the hob, it remembers your heat settings and applies it next time you activate the function.
- If you want to change the heat setting, lift up the cookware and place it on a different zone. Sliding the cookware can cause scratches and discolouration of the surface.

1. Touch  to activate the function. The symbol turns red and the slider displays the pre-set power level. All cooking zones operate for 9 minutes.
2. Touch the slider and choose the appropriate heat setting to adjust the power level.

The slider displays the adjusted power level.

After 9 minutes, an acoustic signal sounds and the empty cooking zones are deactivated. Touch  to resume this function.

To deactivate the function, touch . The symbol turns white.

## 5.12 Hob<sup>2</sup>Hood

It is an advanced automatic function which connects the hob to a special hood. Both the hob and the hood have an infrared signal communicator. Speed of the fan is defined automatically on the basis of the mode setting and temperature of the hottest cookware on the hob. You can also operate the fan from the hob manually.

-  For most of the hoods, the remote system is originally deactivated. Activate it before you use the function. For more information refer to the hood user manual.

### Operating the function automatically

To operate the function automatically set the automatic mode to H1 – H6. The hob is originally set to H5. The hood reacts whenever you operate the hob. The hob recognizes the temperature of the cookware automatically and adjusts the speed of the fan.

### Activating the light

You can set the hob to activate the light automatically whenever you activate the hob. To do so set the automatic mode to H1 – H6.

-  The light on the hood deactivates 2 minutes after deactivating the hob.

### Automatic modes

	Auto- matic light	Boil- ing <sup>1)</sup>	Frying <sup>2)</sup>
Mode H0	Off	Off	Off
Mode H1	On	Off	Off





	Auto- matic light	Boil- ing <sup>1)</sup>	Frying <sup>2)</sup>
Mode H2 <sup>3)</sup>	On	Fan speed 1	Fan speed 1
Mode H3	On	Off	Fan speed 1
Mode H4	On	Fan speed 1	Fan speed 1
Mode H5	On	Fan speed 1	Fan speed 2
Mode H6	On	Fan speed 2	Fan speed 3

1) The hob detects the boiling process and activates the fan speed in accordance with the automatic mode.

2) The hob detects the frying process and activates the fan speed in accordance with the automatic mode.

3) This mode activates the fan and the light and does not rely on the temperature.

## Changing the automatic mode

- Deactivate the appliance.
- Touch  for 3 seconds. The display comes on and goes off.
- Touch  for 3 seconds.
- Touch  a few times until  comes on.
- Touch  of the Timer to select an automatic mode.



When you finish cooking and deactivate the hob, the hood fan may still operate for a certain period of time. After that time the system deactivates the fan automatically and prevents you from an accidental activation of the fan for the next 30 seconds.

-  To operate the hood directly on the hood panel deactivate the automatic mode of the function.

## Operating the fan speed manually

You can also operate the fan from the hob manually.







Touch  when the hob is active. This deactivates automatic operation of the function and allows you to change the fan speed manually.

When you press , you raise the fan speed by one. When you reach an intensive level and press  again, you set the fan speed to 0 which deactivates the hood fan. To start the fan again with the fan speed 1 touch .

-  To activate an automatic operation of the function, deactivate the hob and activate it again.

## 5.13 OffSound Control (Deactivating and activating the sounds)

Deactivate the hob first.

1. Touch  for 3 seconds to activate the function. The display comes on and goes out.
2. Touch  for 3 seconds.  or  comes on.
3. Touch  of the timer to choose one of the following:
  -  - the sounds are off
  -  - the sounds are on
4. Wait until the hob deactivates automatically to confirm your selection.

When the function is set to  you can hear the sounds only when:

- you touch 
- Minute Minder comes down
- Count Down Timer comes down
- you put something on the control panel.

## 5.14 Power management function

- Cooking zones are grouped according to the location and number of the phases in the hob. See the illustration.
- Each phase has a maximum electricity loading of 3680 W.
- The function divides the power between cooking zones connected to the same phase.
- The function activates when the total electricity loading of the cooking zones connected to a single phase exceeds 3680 W.
- The function decreases the power of the other cooking zones connected to the same phase.
- For cooking zones that have a reduced power, the control panel shows the maximum possible heat settings.
- If a higher heat setting is not available reduce it for the other cooking zones first.
- The activation of the function depends on the number and size of pots.

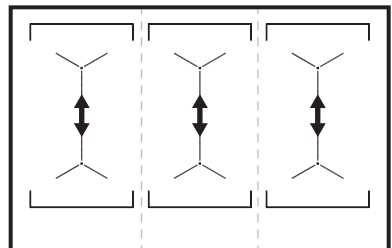

## 6. HINTS AND TIPS



**WARNING!**  
Refer to Safety chapters.

### 6.1 Cookware

-  For induction cooking zones a strong electro-magnetic field creates the heat in the cookware very quickly.

**i** Use the induction cooking zones with suitable cookware.

**Cookware material**

- **correct:** cast iron, steel, enamelled steel, stainless steel, multi-layer bottom (with a correct marking from a manufacturer).
- **not correct:** aluminium, copper, brass, glass, ceramic, porcelain.

**Cookware is suitable for an induction hob if:**

- water boils very quickly on a zone set to the highest heat setting.
- a magnet pulls on to the bottom of the cookware.

**i** The bottom of the cookware must be as thick and flat as possible. Ensure pan bases are clean and dry before placing on the hob surface.

**Cookware dimensions**

Induction cooking zones adapt to the dimension of the bottom of the cookware automatically.

The cooking zone efficiency is related to the diameter of the cookware. The cookware with a diameter smaller than the minimum receives only a part of the power generated by the cooking zone.

**i** Refer to "Technical data".

**6.2 The noises during operation**

**If you can hear:**

- crack noise: cookware is made of different materials (sandwich construction).
- whistle sound: you use the cooking zone with high power level and the cookware is made of different materials (sandwich construction).
- humming: you use high power level.
- clicking: electric switching occurs.
- hissing, buzzing: the fan operates.

**The noises are normal and do not refer to hob malfunction.**

**6.3 Öko Timer (Eco Timer)**

To save energy, the heater of the cooking zone deactivates before the count down timer sounds. The difference in the operation time depends on the heat setting level and the length of the cooking operation.

**6.4 Examples of cooking applications**

The correlation between the heat setting of a zone and its consumption of power is not linear. When you increase the heat setting, it is not proportional to the increase of the consumption of power. It means that a cooking zone with the medium heat setting uses less than a half of its power.

**i** The data in the table is for guidance only.

Heat setting	Use to:	Time (min)	Hints
1	Keep cooked food warm.	as necessary	Put a lid on the cookware.
1 - 2	Hollandaise sauce, melt: butter, chocolate, gelatine.	5 - 25	Mix from time to time.
1 - 2	Solidify: fluffy omelettes, baked eggs.	10 - 40	Cook with a lid on.

Heat setting	Use to:	Time (min)	Hints
2 - 3	Simmer rice and milkbased dishes, heat up ready-cooked meals.	25 - 50	Add at least twice as much liquid as rice, mix milk dishes halfway through the procedure.
3 - 4	Steam vegetables, fish, meat.	20 - 45	Add a couple of tablespoons of liquid.
4 - 5	Steam potatoes.	20 - 60	Use max. ¼ l of water for 750 g of potatoes.
4 - 5	Cook larger quantities of food, stews and soups.	60 - 150	Up to 3 l of liquid plus ingredients.
6 - 7	Gentle fry: escalope, veal cordon bleu, cutlets, rissoles, sausages, liver, roux, eggs, pancakes, doughnuts.	as necessary	Turn halfway through.
7 - 8	Heavy fry, hash browns, loin steaks, steaks.	5 - 15	Turn halfway through.
9	Boil water, cook pasta, sear meat (goulash, pot roast), deep-fry chips.		
Boil large quantities of water. PowerBoost is activated.			

## 6.5 Hints and Tips for Hob<sup>2</sup>Hood

When you operate the hob with the function:

- Protect the hood panel from direct sunlight.
- Do not spot halogen light on the hood panel.
- Do not cover the hob control panel.
- Do not interrupt the signal between the hob and the hood (for example with a hand or a cookware handle). See the picture.

**The hood in the picture is only exemplary.**

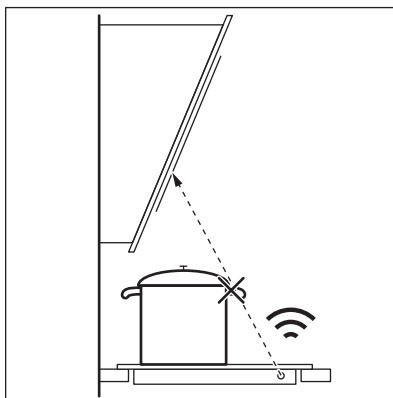

Other remotely controlled appliances may block the signal. Do not use any remotely controlled appliances at the time when you use the function on the hob.

**Cooker hoods with the Hob<sup>2</sup>Hood function**



To find the full range of cooker hoods which work with this function refer to our

consumer website. The Electrolux cooker hoods that work with this function must have the symbol .

## 7. CARE AND CLEANING



### WARNING!

Refer to Safety chapters.

### 7.1 General information

- Clean the hob after each use.
- Always use cookware with a clean base.
- Scratches or dark stains on the surface have no effect on how the hob operates.
- Use a special cleaner suitable for the surface of the hob.
- Use a special scraper for the glass.

### 7.2 Cleaning the hob

- **Remove immediately:** melted plastic, plastic foil, sugar and food with sugar,

otherwise, the dirt can cause damage to the hob. Take care to avoid burns. Use a special hob scraper on the glass surface at an acute angle and move the blade on the surface.

- **Remove when the hob is sufficiently cool:** limescale rings, water rings, fat stains, shiny metallic discoloration. Clean the hob with a moist cloth and a non-abrasive detergent. After cleaning, wipe the hob dry with a soft cloth.
- **Remove shiny metallic discoloration:** use a solution of water with vinegar and clean the glass surface with a cloth.

## 8. TROUBLESHOOTING







### WARNING!

Refer to Safety chapters.

### 8.1 What to do if...

Problem	Possible cause	Remedy
You cannot activate or operate the hob.	The hob is not connected to an electrical supply or it is connected incorrectly.	Check if the hob is correctly connected to the electrical supply. Refer to the connection diagram.
	The fuse is blown.	Make sure that the fuse is the cause of the malfunction. If the fuse is blown again and again, contact a qualified electrician.
	You touched 2 or more sensor fields at the same time.	Touch only one sensor field.
	Pause operates.	Refer to "Daily use".
	There is water or fat stains on the control panel.	Clean the control panel.

Problem	Possible cause	Remedy
You cannot select the maximum heat setting for one of the cooking zones.	The other zones consume the maximum available power. Your hob works properly.	Reduce the heat setting of the other cooking zones connected to the same phase. Refer to "Power management".
An acoustic signal sounds and the hob deactivates. An acoustic signal sounds when the hob is deactivated.	You put something on one or more sensor fields.	Remove the object from the sensor fields.
The hob deactivates.	You put something on the sensor field  .	Remove the object from the sensor field.
Residual heat indicator does not come on.	The zone is not hot because it operated only for a short time or the sensor is damaged.	If the zone operated sufficiently long to be hot, speak to an Authorised Service Centre.
Hob <sup>2</sup> Hood does not work.	You covered the control panel.	Remove the object from the control panel.
The sensor fields become hot.	The cookware is too large or you put it too near to the controls.	Put large cookware on the rear zones if possible.
There is no sound when you touch the panel sensor fields.	The sounds are deactivated.	Activate the sounds. Refer to "Daily use".
 comes on.	Child Safety Device or Lock operates.	Refer to "Daily use".
 and a number come on.	There is an error in the hob.	Deactivate the hob and activate it again after 30 seconds. If  comes on again, disconnect the hob from the electrical supply. After 30 seconds, connect the hob again. If the problem continues, speak to an Authorised Service Centre.
You can hear a constant beep noise.	The electrical connection is incorrect.	Disconnect the hob from the electrical supply. Ask a qualified electrician to check the installation.

## 8.2 If you cannot find a solution...

If you cannot find a solution to the problem yourself, contact your dealer or an Authorised Service Centre. Give the data from the rating plate. Make sure, you operated the hob correctly. If not the

servicing by a service technician or dealer will not be free of charge, also during the warranty period. The instructions about the Service Centre and conditions of guarantee are in the guarantee booklet.

# 9. TECHNICAL DATA

## 9.1 Rating plate

Model EIV9467  
Typ 61 E6A 04 AA  
Induction 11.0 kW  
Ser.Nr. ....  
ELECTROLUX

PNC 949 596 708 00  
400 V 3N 50 - 60 Hz  
Made in Germany  
11.0 kW



## 9.2 Cooking zones specification

Cooking zone	Nominal power (maximum heat setting) [W]	PowerBoost [W]	PowerBoost maximum duration [min]	Cookware diameter [mm]
Left front	2300	3200	10	125 - 210
Left rear	2300	3200	10	125 - 210
Middle front	2300	3200	10	125 - 210
Middle rear	2300	3200	10	125 - 210
Right front	2300	3200	10	125 - 210
Right rear	2300	3200	10	125 - 210

The power of the cooking zones can be different in some small range from the data in the table. It changes with the material and dimensions of the cookware.

For optimal cooking results use cookware no larger than the diameter in the table.

# 10. ENERGY EFFICIENCY

## 10.1 Product information according to EU 66/2014

Model identification	EIV9467
Type of hob	Built-In Hob
Number of cooking areas	3

Heating technology		Induction
Lenght (L) and width (W) of the cooking area	Left	L 37.9 cm W 22.0 cm
Lenght (L) and width (W) of the cooking area	Middle	L 37.9 cm W 22.0 cm
Lenght (L) and width (W) of the cooking area	Right	L 37.9 cm W 22.0 cm
Energy consumption of the cooking area (EC electric cooking)	Left	186.8 Wh / kg
Energy consumption of the cooking area (EC electric cooking)	Middle	186.8 Wh / kg
Energy consumption of the cooking area (EC electric cooking)	Right	186.8 Wh / kg
Energy consumption of the hob (EC electric hob)		186.8 Wh / kg

EN 60350-2 - Household electric cooking appliances - Part 2: Hobs - Methods for measuring performance

## 10.2 Energy saving

You can save energy during everyday cooking if you follow below hints.

- When you heat up water, use only the amount you need.
- If it is possible, always put the lids on the cookware.
- Before you activate the cooking zone put the cookware on it.
- Put the smaller cookware on the smaller cooking zones.
- Put the cookware directly in the centre of the cooking zone.
- Use the residual heat to keep the food warm or to melt it.

## 11. ENVIRONMENTAL CONCERNS

Recycle materials with the symbol . Put the packaging in relevant containers to recycle it. Help protect the environment and human health by recycling waste of electrical and electronic appliances. Do not dispose of

appliances marked with the symbol  with the household waste. Return the product to your local recycling facility or contact your municipal office.







[www.electrolux.com/shop](http://www.electrolux.com/shop)



867346014-B-032019

