



xiaomi ACM15SC Smart Air Purifier 4 Pro User Manual

[Home](#) » [Xiaomi](#) » xiaomi ACM15SC Smart Air Purifier 4 Pro User Manual 

Contents

- 1 [xiaomi ACM15SC Smart Air Purifier 4 Pro](#)
- 2 [READ AND SAVE THESE INSTRUCTIONS](#)
- 3 [WARNING](#)
- 3 [Precautions](#)
- 4 [Product Overview](#)
 - 4.1 [Display Instructions](#)
- 5 [Installation](#)
- 6 [How to Use](#)
- 7 [How to Use](#)
- 8 [Daily Care & Maintenance](#)
- 9 [Specifications](#)
- 10 [Documents / Resources](#)
- 11 [Related Posts](#)



xiaomi

xiaomi ACM15SC Smart Air Purifier 4 Pro



READ AND SAVE THESE INSTRUCTIONS WARNING

- When the power cord is damaged, it must be replaced with a genuine power cord purchased from the manufacturer or after-sales service department.
- This appliance can be used by children aged from 8 years and above and persons with reduced physical, sensory or mental capabilities or lack of experience and knowledge if they have been given supervision or instruction concerning use of the appliance in a safe way and understand the hazards involved.
- Children shall not play with the appliance. Cleaning and user maintenance shall not be made by children without supervision.
- Make sure the purifier is turned off and unplugged before performing the maintenance. Fix the grille with screw after cleaning fan blades and air duct.
- This appliance has a polarized plug (one blade is wider than the other). To reduce the risk of electric shock, this plug is intended to fit in a polarized outlet only one way. If the plug does not fit fully in the outlet, reverse the plug. If it still does not fit, contact a qualified electrician. Do not attempt to defeat this safety feature.
- To reduce the risk of fire or electric shock, do not use this appliance with any solid-state speed control device.

Precautions

- Turn off and unplug the purifier before moving it.
- The purifier cannot turn on when the fan grille and the filter compartment cover are not installed properly.
- Maintain a distance of at least 20 cm between the air inlets and walls or other objects.
- The purifier must be placed on firm and flat floor.
- Prior to cleaning or other maintenance, the appliance must be disconnected from the supply mains.
- Frequently remove dust, hair, and other particles from the outer mesh screen of the filter, so as to reduce the chance of bacteria growth.
- Remove dust, hair, and particles from the purifier's air inlets to prevent a reduction of air intake.
- Cover the air outlet to prevent dust, hair, and other particles from falling in when the purifier is left unused for a

long time.

To avoid fire, electric shocks, or other damage, use the power cord and electrical outlet as instructed below:

- Do not excessively pull, twist or bend the power cord, as this may expose or break the cord's core.
- The power cord must be plugged into a suitable electrical outlet.
- Use the power cord that is provided with the purifier, do not use any third party power cords.
- Always unplug the purifier before carrying out maintenance to or moving the air purifier.
- Immediately stop using the purifier when it makes unusual sounds, gives off bad odors, overheats, or its fan rotates irregularly.
- Do not stick your fingers or foreign objects into the protective parts, movable parts, air inlets, or air outlets.
- Keep objects such as hairs or fabrics away from the purifier to avoid blocking the air inlets or air outlets.
- Do not sit on, lean on or tilt the purifier.
- When using in conjunction with gas-fueled appliances (such as gas stoves, gas heaters), please ventilate sufficiently to avoid carbon monoxide poisoning.
- Do not pour liquids, nor throw powders or other small substances into the purifier's air outlet.

Do not use the purifier in the following circumstances, as they may result in electric shocks, fire, or other damage:

- Near open flames, such as candles, incense burners, stoves, fireplaces, cigarettes, firecrackers, lighters, multipurpose torches, candle lighters, or fire pans.
- Near appliances that generate high temperatures, such as electric heaters, fan heaters, electric foot warmers, electric stoves, or electric irons.
- Make sure no inflammable objects get into the purifier.
- In unstable locations where the purifier can easily fall over.
- In environments that are extremely hot, humid, or damp, such as bathrooms.

Product Overview

Read this manual carefully before use, and retain it for future reference.

Note: Illustrations of the product, accessories, and user interface in this user manual are for reference purposes only. The actual product and functions may vary due to product enhancements.

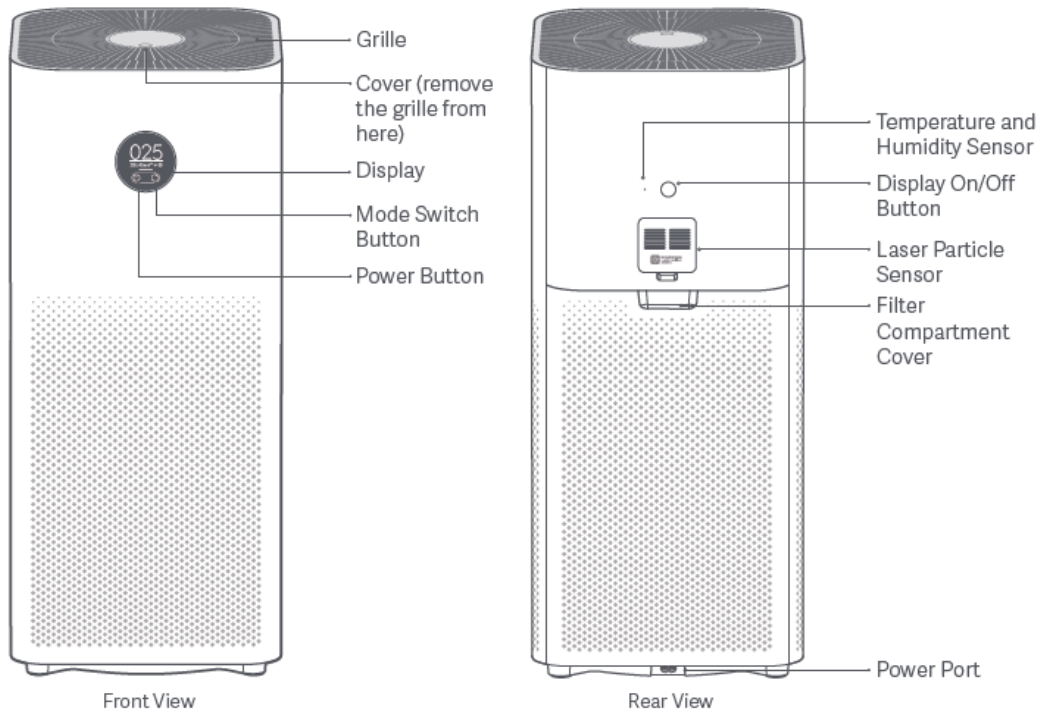

Display Instructions

Display Instructions

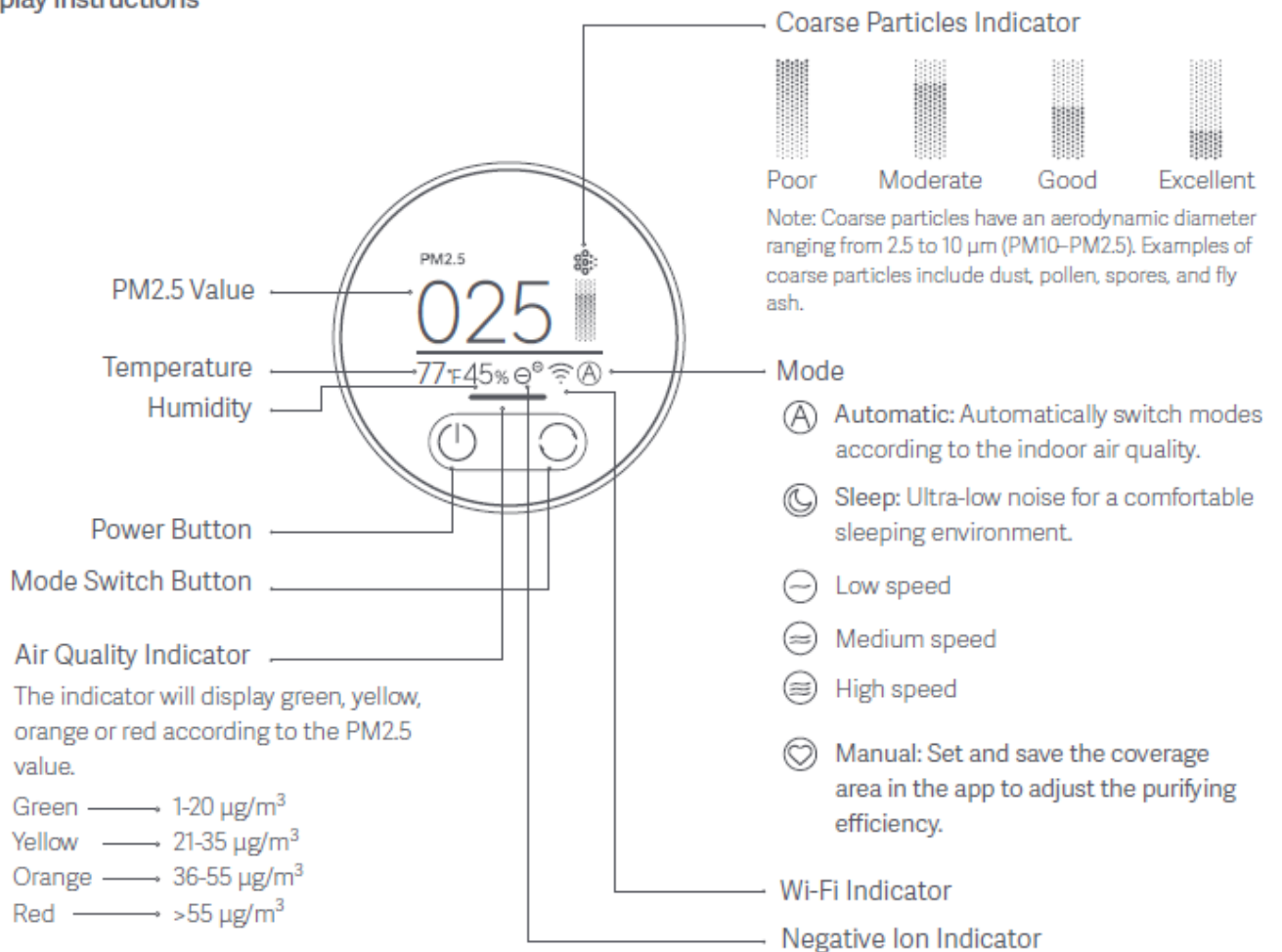

Installation

Placing the purifier For optimal performance, make sure the distances between purifier's air inlets and other objects such as walls meet the requirements as suggested below.

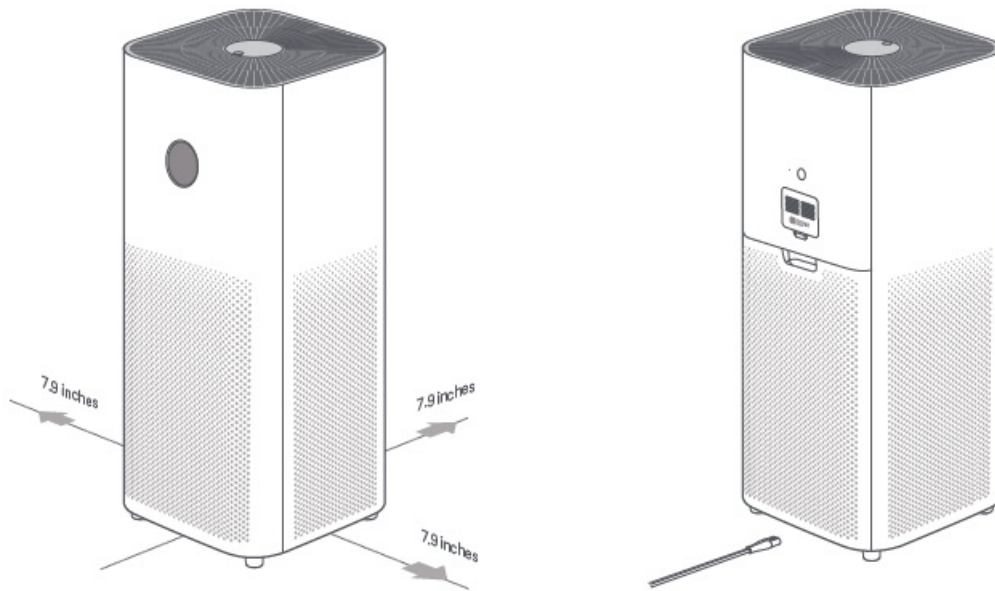

Connecting to an electrical outlet Connect the power cord to the power port at the bottom of the purifier and then plug it into an electrical outlet.

Note: It is recommended to keep doors and windows closed for a better purifying effect when using the purifier.

How to Use

Turning on/off

Tap the power button to turn on the purifier. While the purifier is on, tap the power button to turn it off.



Switching mode



Filter life notification

The display will show the remaining service time of the filter when the purifier is turned on. The display will show a

warning icon if no genuine filter is detected.



Filter service
time remaining
notification



Not a genuine filter
warning

Adjusting the display's brightness

Press the display on/off button to cycle through its brightness levels: on, dim, and off.

Resetting Wi-Fi

When connecting the purifier to the app for the first time or unable to connect to it, press and hold the display on/off button for 7 seconds. The purifier will make a notification sound once Wi-Fi is successfully reset.

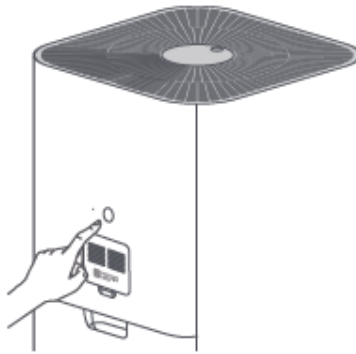

Enabling/disabling the child lock function

Press and hold the mode switch button for 7 seconds to enable or disable the child lock function. The purifier will make the corresponding notification sound and show the corresponding icon on the display.

How to Use

Enabling/Disabling Wi-Fi

Simultaneously press and hold the mode switch button on the display and the brightness adjustment button for 15 seconds. The purifier will make a notification sound and the Wi-Fi will be disabled.

While Wi-Fi is off, simultaneously press and hold the mode switch button on the display and the brightness adjustment button for 15 seconds. The purifier will make a notification sound and the Wi-Fi will be enabled.

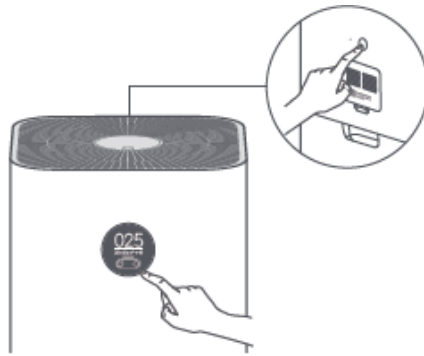

Connect with Mi Home / Xiaomi Home App This product works with Mi Home / Xiaomi Home app*. Control your device with Mi Home / Xiaomi Home app.



Scan the QR code to download and install the app. You will be directed to the connection setup page if the app is installed already. Or search “Mi Home / Xiaomi Home” in the app Store to download and install it. Open Mi Home / Xiaomi Home app, tap “+” on the upper right, and then follow prompts to add your device. *The app is referred to as Xiaomi Home app in Europe (except for Russia). The name of the app displayed on your device should be taken as the default. Note: The version of Mi Home app might have been updated, please follow the instructions based on the current app version.

Daily Care & Maintenance

Warning: Make sure the purifier is turned off and unplugged before performing the following operations.

Cleaning fan blades and air duct

- Press the indentation on the cover to open it. Use a screwdriver to loosen the screw, and then pull the cover upwards to remove the grille.
- Use a vacuum cleaner to remove any dust from the air duct and fan blades, or wipe the dust off gently with a soft cloth.
- Use a brush or soft cloth to gently wipe the negative ion transmitter.
- Install the grille back and fasten the screw after cleaning.

Note: To avoid missing, the screw is not removable. Loosen the screw to remove the grille.

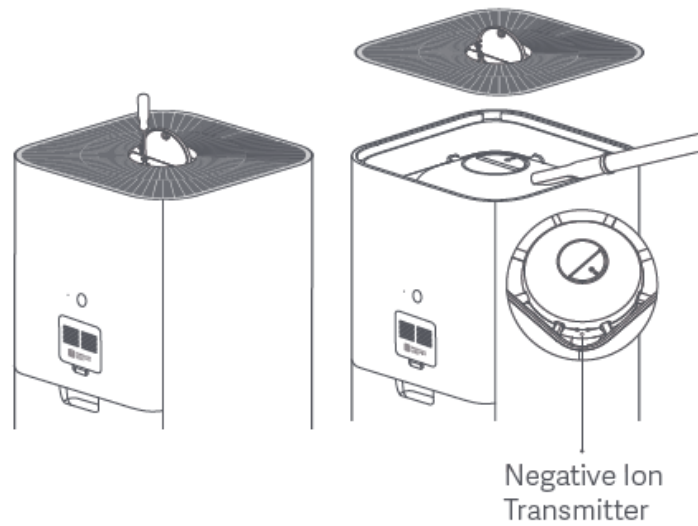

Note: To avoid damaging the purifier, do not rinse or spray the air duct and fan blades directly with water, or wipe them with a soaking wet cloth.

Cleaning the filter compartment: To ensure optimal ventilation and purification, use a vacuum cleaner to remove any dust from the air inlets and the filter compartment, or wipe these areas gently with a soft cloth.

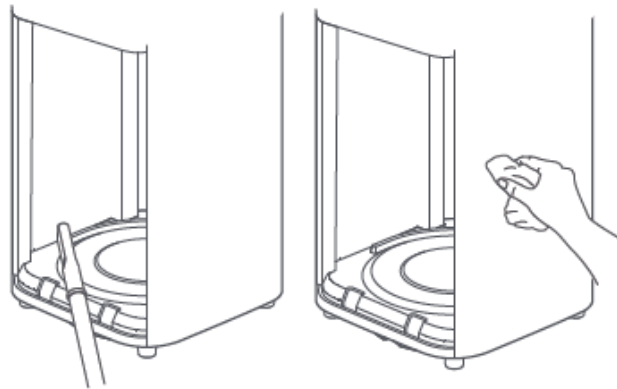

Note: To avoid damaging the purifier, do not rinse or spray the filter compartment directly with water, or wipe it with a soaking wet cloth.

Cleaning the laser particle sensor : Use a non-sharp tool to open the cover of the laser particle sensor, then use an air blow gun or hair dryer to clean the filter on the cover and the sensor, as illustrated in the figure

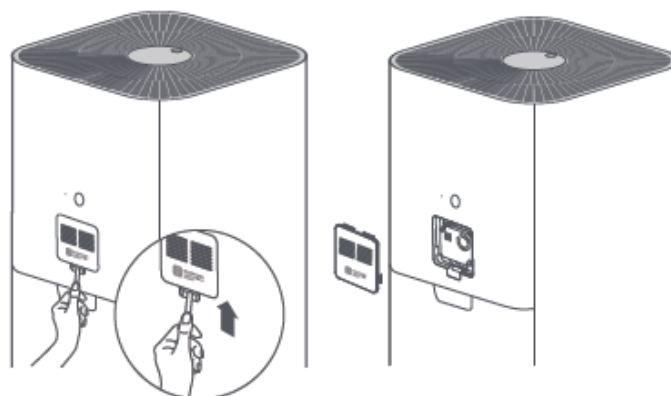

Note: Do not use hot air..

Specifications

- **Name:** Xiaomi Smart Air Purifier 4 Pro
- **Model:** AC-M15-SC
- **Item Dimensions:** 10.8 × 10.8 × 26.7 inches
- **Net Weight:** Approx. 15 lbs
- **Effective Coverage:** 35–60 m² *
- **Rated Voltage:** 120 V~
- **Rated Frequency:** 60 Hz
- **Rated Power:** 50 W
- **Noise Level:** ≤65 dB(A)
*Calculated according to standard GB/T 18801-2015
- **Particle Purification Efficiency:** High
- **Formaldehyde Purification Efficiency:** High
- **Particle's Clean Air Delivery Rate (CADR Particle):** 500 m³/h
- **Formaldehyde's Clean Air Delivery Rate (CADR Formaldehyde):** 185 m³/h
- **Wireless Connectivity:** Wi-Fi IEEE 802.11 b/g/n 2.4 GHz

Documents / Resources

	<p>xiaomi ACM15SC Smart Air Purifier 4 Pro [pdf] User Manual ACM15SC, 2AP98-ACM15SC, 2AP98ACM15SC, ACM15SC Smart Air Purifier 4 Pro, Smart Air Purifier 4 Pro, 4 Pro</p>
---	--