

# Optimate 32L

FR

NL

DE

EN

ES

IT

PT

RU

KK

UK

BG

RO

HR

CZ

HU

SK



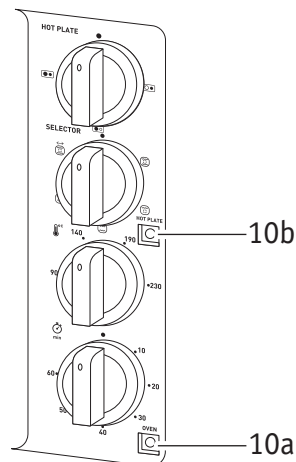
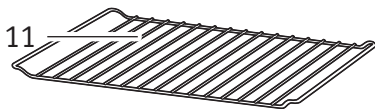
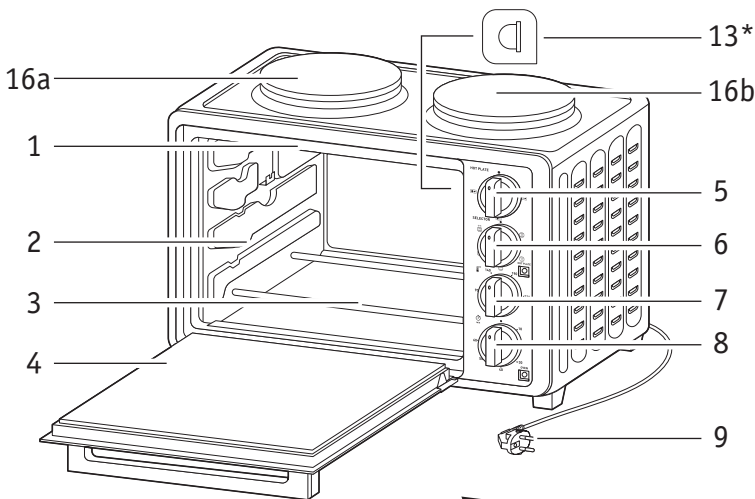

\* selon modèle - afhankelijk van het model - je nach Modell - depending on the model - según el modelo - in base al modelo -  
 consoante o modelo - В зависимости от модели - үлгіге байланысты - залежно від моделі - В зависимости от модели -  
 În funcție de model - ovisno o modelu - v závislosti na modelu - modelltól függően - v závislosti na modeli

1

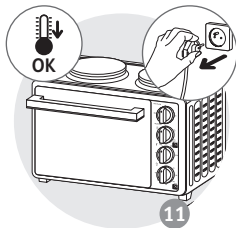
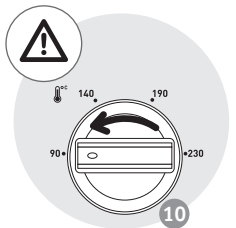
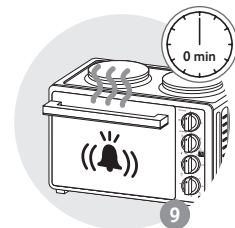
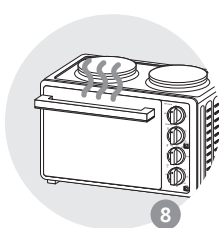
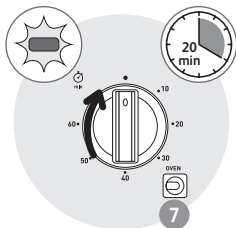
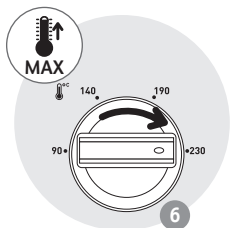
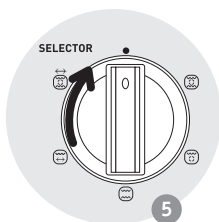
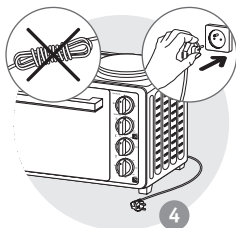
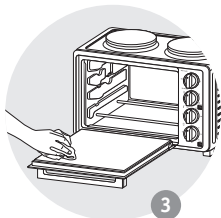
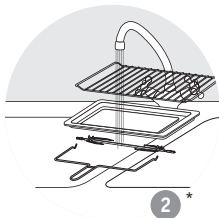
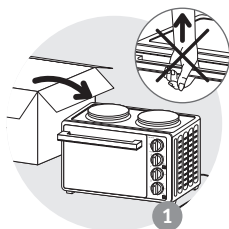

\* selon modèle  
afhankelijk van het model  
je nach Modell  
depending on the model  
según el modelo  
in base al modelo  
consoante o modelo  
В зависимости от модели  
үлгіге байланысты  
залежно від моделі  
В зависимости от модели  
In functie de model  
ovisno o modelu  
v závislosti na modelu  
modelltól függően  
v závislosti na modeli

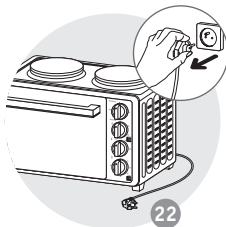
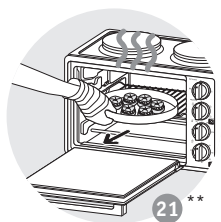
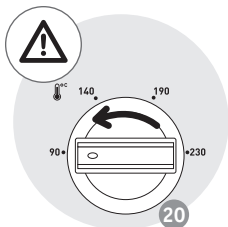
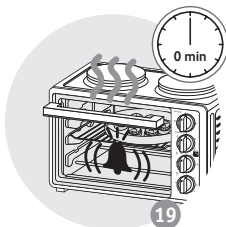
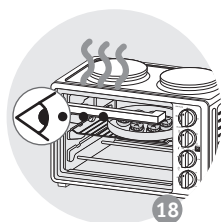
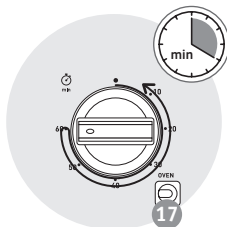
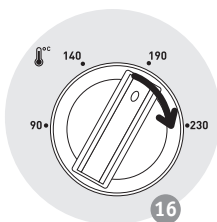
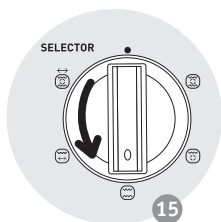
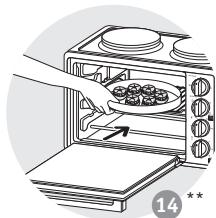
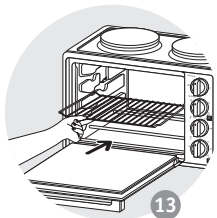
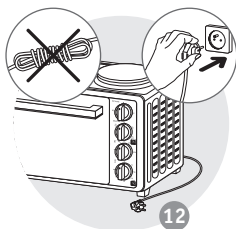

\*\* Plat non fourni avec l'appareil  
 Schaaf niet bij het apparaat inbegrepen  
 Platte nicht im Lieferumfang inbegriffen  
 The dish is not supplied with the appliance  
 El plato no es suministrado con el aparato  
 Piatto non fornito con l'apparecchio  
 Travessa não fornecida com o aparelho  
 Блюдо не входит в комплект  
 Құрылғымен бірге тәрелке  
 қамтамасыз етілмейді  
 Блюдо не входит в комплект  
 поставки приладу  
 Съдът не се предоставя с уреда  
 Tava nu este furnizată cu aparatul.  
 Posude se ne isporučuje uz uređaj  
 Miska není dodávána se spotřebičem  
 A tál nem a készülék tartozéka  
 Miska sa nedodáva so spotrebičom

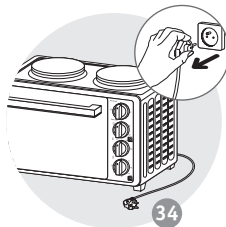
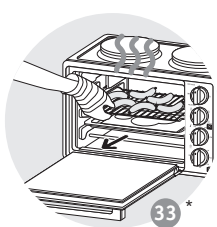
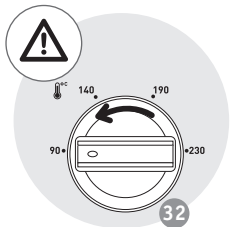
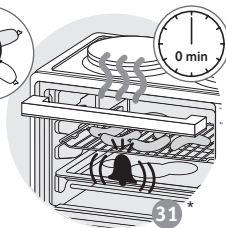
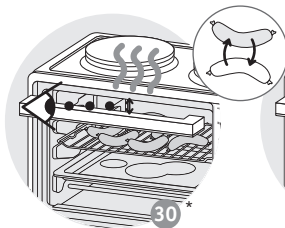
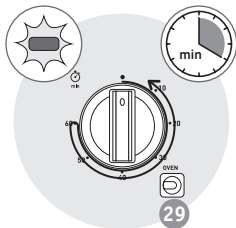
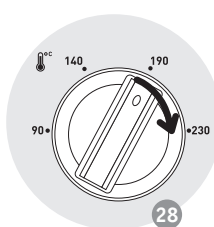
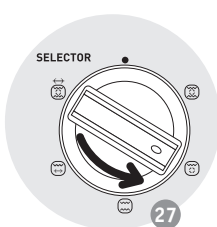
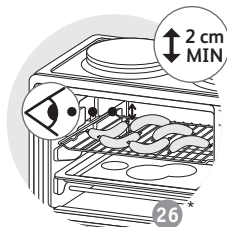
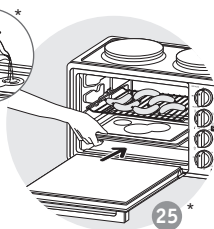
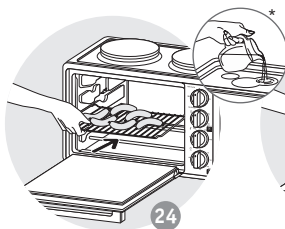
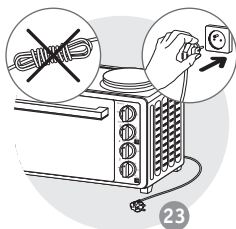

\* selon modèle - afhankelijk van het model - je nach Modell - depending on the model - según el modelo - in base al modelo - consoante o modelo - В зависимости от модели - үлгіге байланысты - залежно від моделі - В зависимости от модели - În funcție de model - ovisno o modelu - v závislosti na modelu - modellől függően - v závislosti na modeli

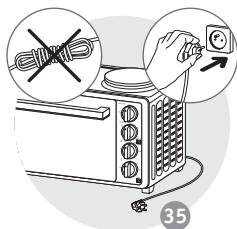

35

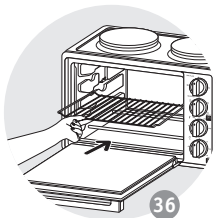

36

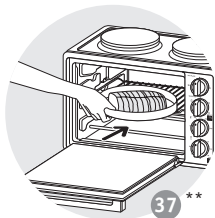

37 \*\*

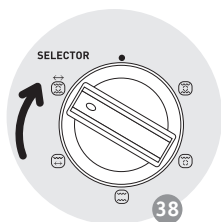

38

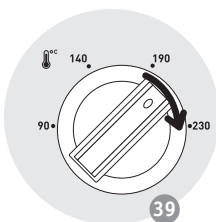

39

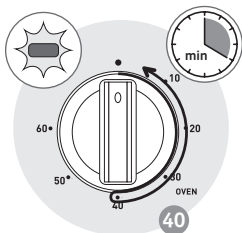

40

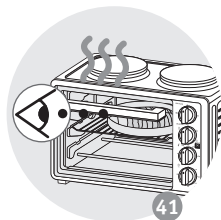

41

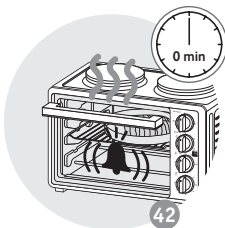

42

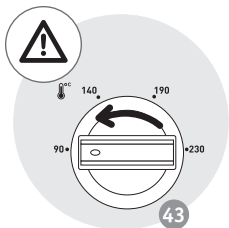

43

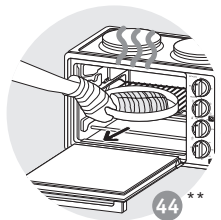

44 \*\*

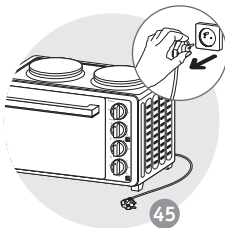

45

\*\* Plat non fourni avec l'appareil  
 Schaal niet bij het apparaat inbegrepen  
 Platte nicht im Lieferumfang inbegriffen  
 The dish is not supplied with the appliance  
 El plato no es suministrado con el aparato  
 Piatto non fornito con l'apparecchio  
 Travessa não fornecida com o aparelho  
 Блюдо не входит в комплект  
 Құрылғымен бірге тәрелке  
 қамтамасыз етілмейді  
 Блюдо не входит в комплект  
 поставки приладу  
 Съдът не се предоставя с уреда  
 Tava nu este furnizată cu aparatul.  
 Posude se ne isporučuje uz uređaj  
 Miska není dodávána se spotřebičem  
 A tál nem a készülék tartozéka  
 Miska sa nedodáva so spotrebičom

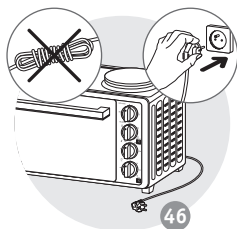

46

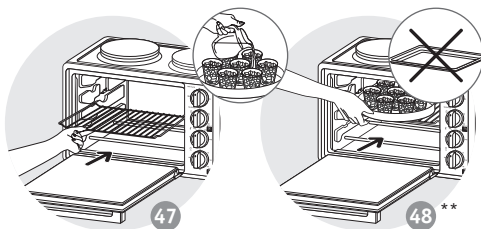

47

48 \*\*

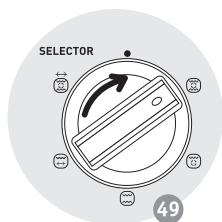

49

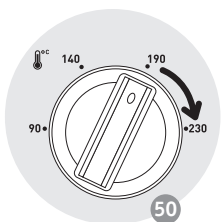

50

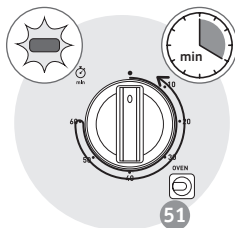

51

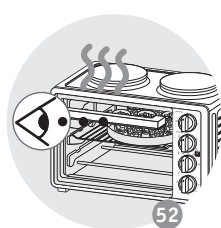

52

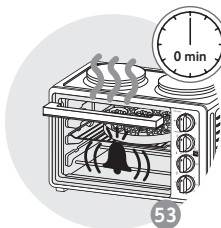

53

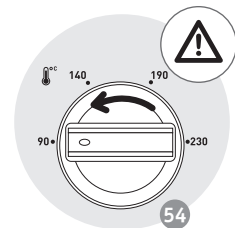

54

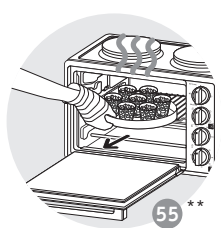

55 \*\*

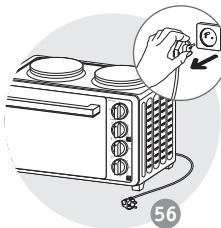

56

\*\* Plat non fourni avec l'appareil  
 Schaaf niet bij het apparaat inbegrepen  
 Platte nicht im Lieferumfang inbegriffen  
 The dish is not supplied with the appliance  
 El plato no es suministrado con el aparato  
 Piatto non fornito con l'apparecchio  
 Travessa não fornecida com o aparelho  
 Блюдо не входит в комплект  
 Құрылғымен бірге тәрепке  
 қамтамасыз етілмейді  
 Блюдо не входит в комплект  
 поставки приладу  
 Съдът не се предоставя с уреда  
 Tava nu este furnizată cu aparatul.  
 Posude se ne isporučuje uz uređaj  
 Miska není dodávána se spotřebičem  
 A tál nem a készülék tartozéka  
 Miska sa nedodáva so spotrebičom

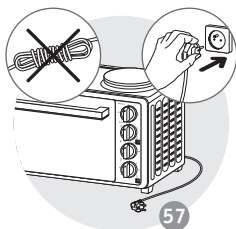

57

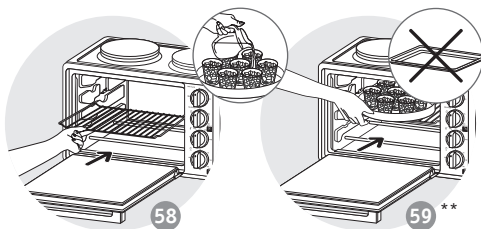

58

59 \*\*

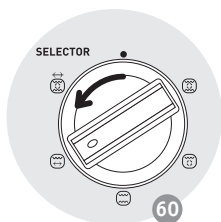

60

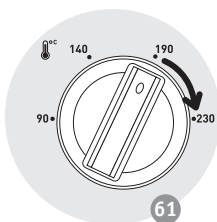

61

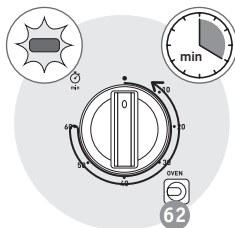

62

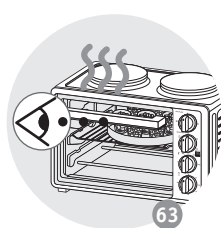

63

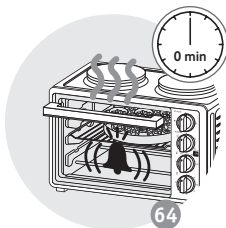

64

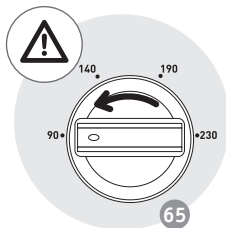

65

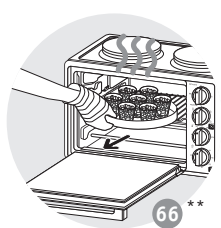

66 \*\*

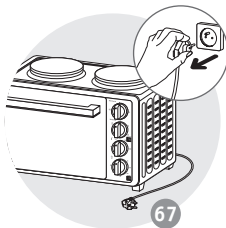

67

\*\* Plat non fourni avec l'appareil  
 Schaaf niet bij het apparaat inbegrepen  
 Platte nicht im Lieferumfang inbegriffen  
 The dish is not supplied with the appliance  
 El plato no es suministrado con el aparato  
 Piatto non fornito con l'apparecchio  
 Travessa não fornecida com o aparelho  
 Блюдо не входит в комплект поставки прибора  
 Съдет не се предоставя с уреда  
 Tava nu este furnizată cu aparatul.  
 Posude se ne isporučuje uz uređaj  
 Miska není dodávána se spotřebičem  
 A tál nem a készülék tartozéka  
 Miska sa nedodáva so spotrebičom



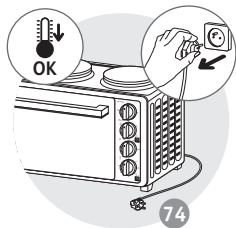
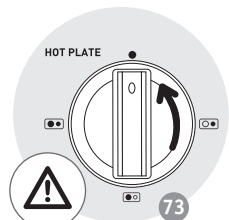
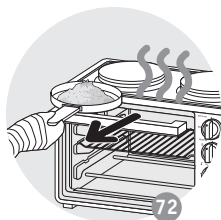
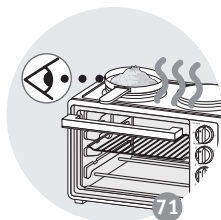
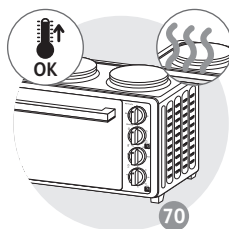
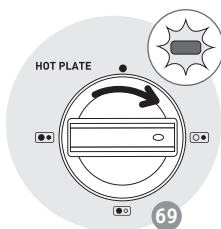
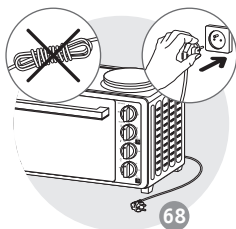

- Important : Une seule plaque chauffante à la fois peut être utilisée avec le four.
- Belangrijk: Er kan tegelijkertijd slechts één kookplaat met de oven worden gebruikt.
- Wichtig: Es kann jeweils nur eine Kochplatte mit dem Backofen benutzt werden.
- Important: Only one hot plate at a time can be operated with oven.
- Importante: Solo se puede poner en funcionamiento una placa de calor cada vez con el horno.
- Důležité! Quando il forno è in funzione è possibile utilizzare una sola piastra di cottura alla volta.
- Importante: Só pode operar uma placa de aquecimento de cada vez com o forno.
- Важно! При включенной духовке допускается работа только одной конфорки.
- Маңызды: пеште бір уақытта тек бір электр плитасымен жұмыс істеуге болады.
- Важно: одновременно с фурнаты може да работи само един от котлоните.
- Important: Numai o singură plită poate fi utilizată simultan cu cuptorul.
- Važno: samo se jedna vruća ploča može istodobno koristiti s pećnicom.
- Důležité: S troubou lze současně provozovat pouze jednu plotýnku.
- Fontos: A sütővel együtt csak egy főzőlap működtethető.
- Dôležité: Súčasne je možné používať iba jednu varnú dosku.

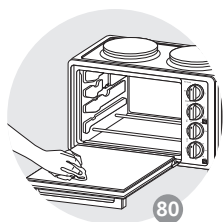
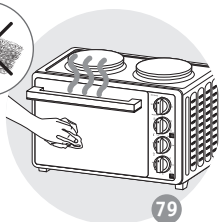
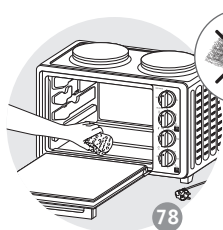
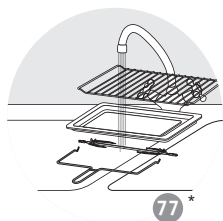
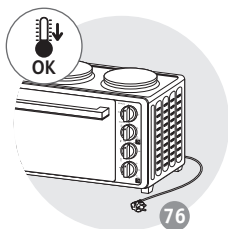
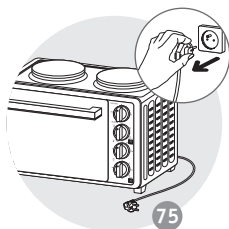

\* selon modèle - afhankelijk van het model - je nach Modell - depending on the model - según el modelo - in base al modello -  
 consoante o modelo - В зависимости от модели - үлгіге байланысты - залежно від моделі - В зависимости от модели -  
 În funcție de model - ovisno o modelu - v závislosti na modelu - modelltól függően - v závislosti na modelu



						min
	x4			10mins	230°C	18
	870g			10mins	230°C	56
	750g			10mins	230°C	40
	500g			-	230°C	57
	1000g			-	230°C	78
	x4			-	230°C	22 
	x8			-	230°C	15 
	350g			10mins	210°C	15
				10mins	230°C	40
	350g			10mins	230°C	15
				-	230°C	26
				10mins	200°C	42
				10mins	200°C	22
				10mins	230°C	55
				10mins	230°C	25
	750g			-	230°C	50

