

RU

UK

KK

EN

Optimo 33L



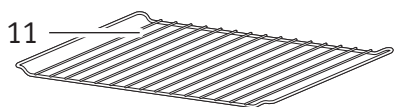
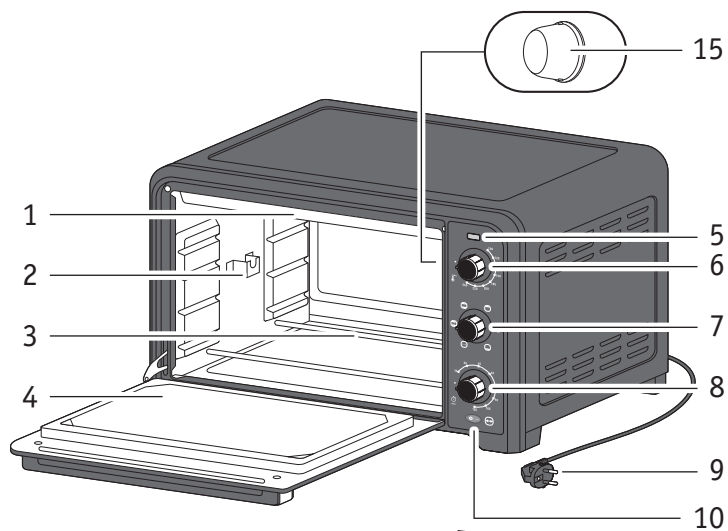

ОПИСАНИЕ

- 1 Верхний нагревательный элемент
- 2 Алюминиевые стенки
- 3 Нижний нагревательный элемент
- 4 Двойная дверца
- 5 Индикатор работы
- 6 Регулятор температуры
- 7 Управление режимами
- 8 Управление таймером
- 9 Кабель питания
- 10 Включение вертела
- 11 Двусторонняя решетка гриля
- 12 Поддон
- 13 Вертел
- 14 Ручка для извлечения вертела
- 15 Внутренняя подсветка

СИПАТТАМА

- 1 Жоғарғы қыздыру элементі
- 2 Алюминий қабырғалар
- 3 Төменгі қыздыру элементі
- 4 Қос қабырғалы есік
- 5 Жұмыс индикаторы
- 6 Температураны басқару түймесі
- 7 Функциялар түймесі
- 8 Таймер түймесі
- 9 Қуат сымы
- 10 Істік қосқышы
- 11 Аударуға болатын тор сәресі
- 12 Тамақ науасы
- 13 Істік бар құрал
- 14 Істік тұтқасы
- 15 Ішкі шам

1

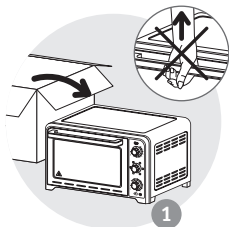

1

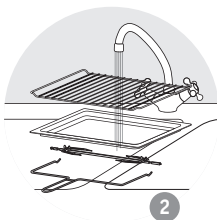

2

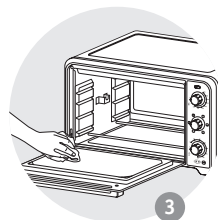

3

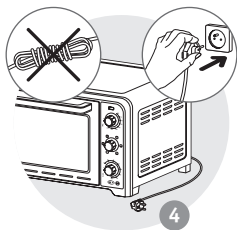

4

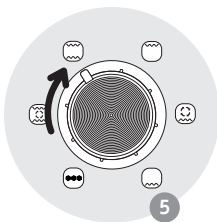

5

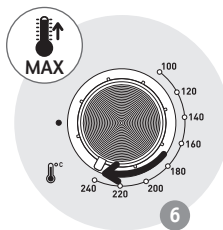

6

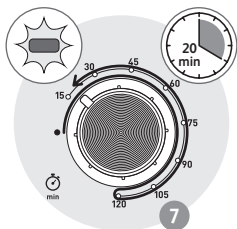

7

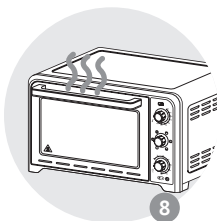

8



9

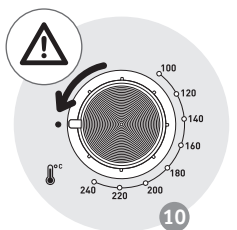

10

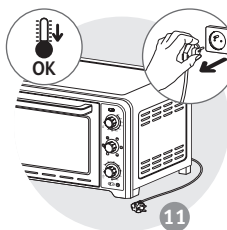

11

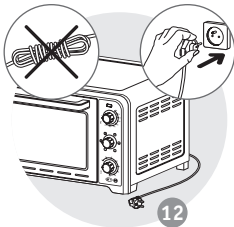

12

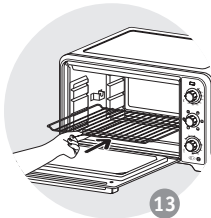

13

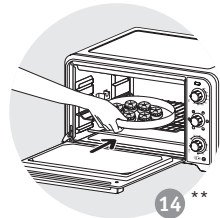

14 **

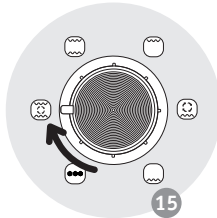

15

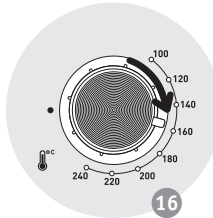

16

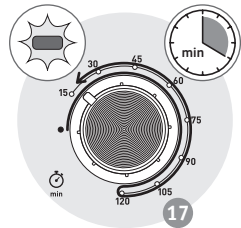

17

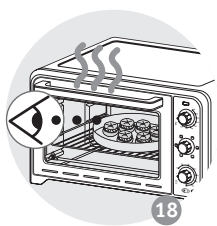

18

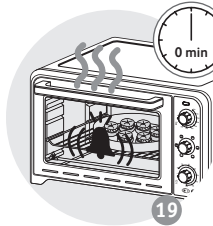

19

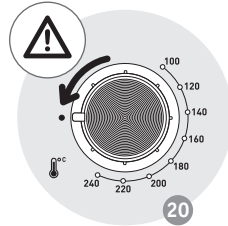

20

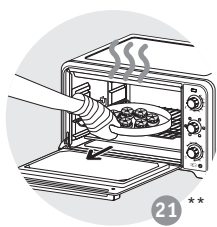

21 **

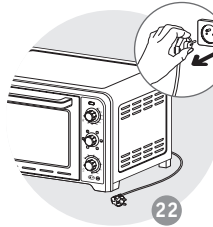

22

** Блюдо не входит в комплект поставки
Посуд не входит в комплект
Төрөлме құрылғымен бірге
қамтамасыз етілмейді
The dish is not supplied with the appliance

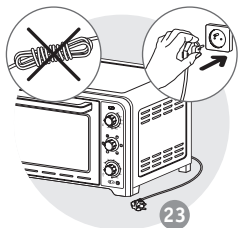

23

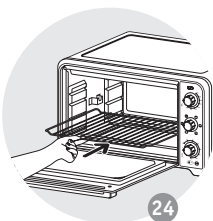

24

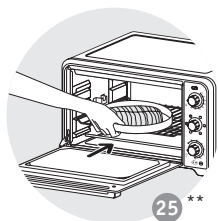

25 **

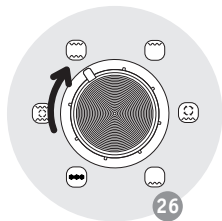

26

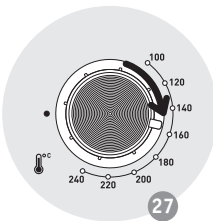

27

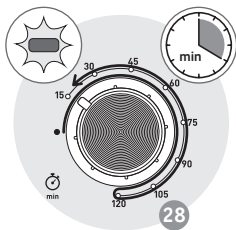

28

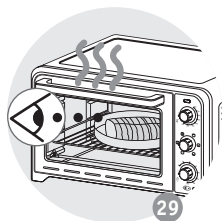

29

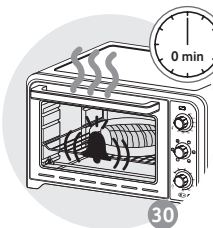

30

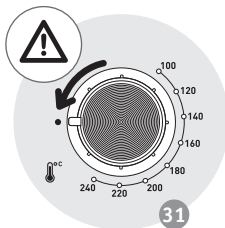

31

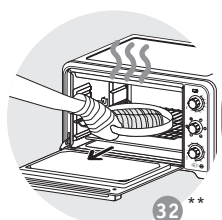

32 **

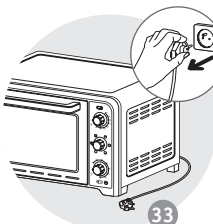

33

** Блюдо не входит в комплект поставки
Посуд не входит в комплект
Төрөлме құрылғымен
бірге қамтамасыз етілмейді
The dish is not supplied with the appliance

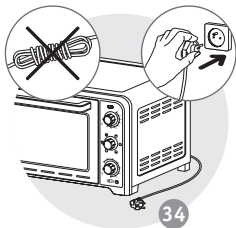

34

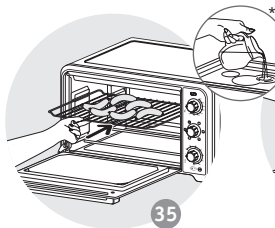

35

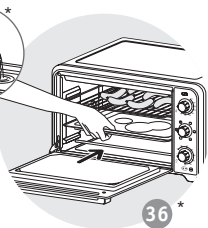

36*

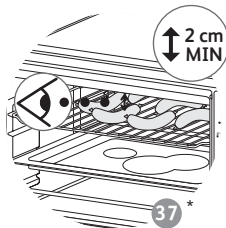

37*

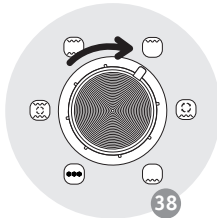

38

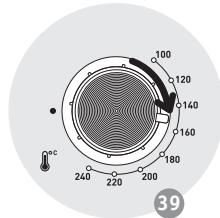

39

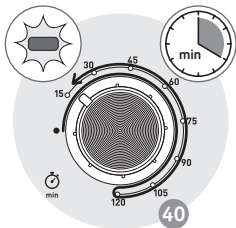

40

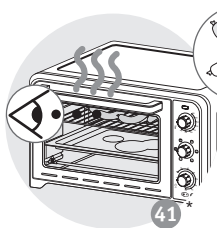

41*

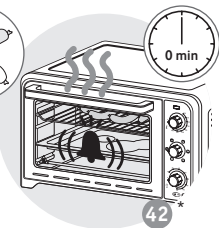

42*

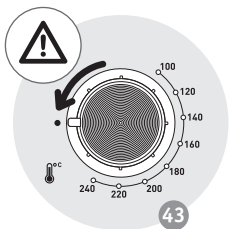

43

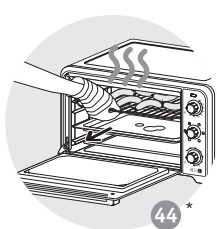

44*

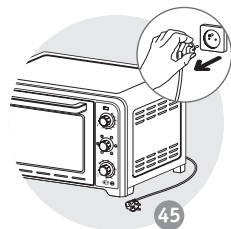

45

* в зависимости от модели - Комплектація в залежності від моделі - үлгіге байланысты - depending on the model

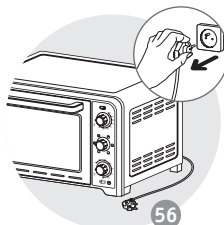
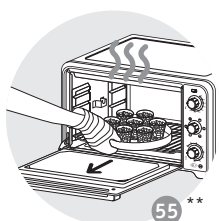
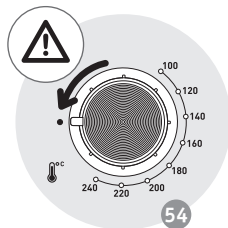
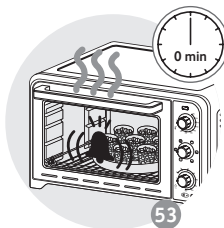
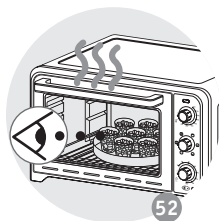
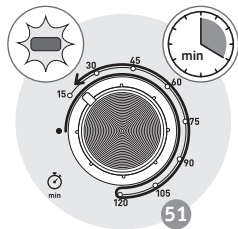
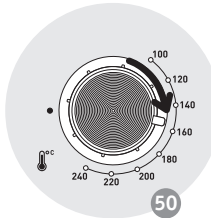
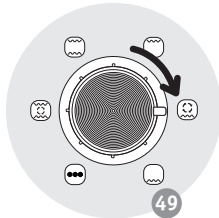
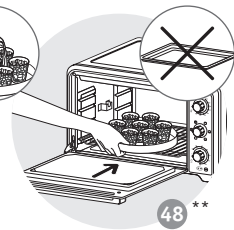
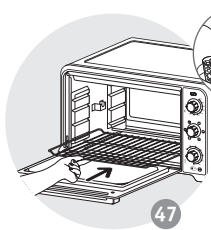
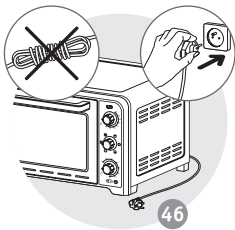

** Блюдо не входит в комплект поставки
Посуд не входит в комплект
Төрөлме құрылғымен бірге
қамтамасыз етілмейді
The dish is not supplied with the appliance

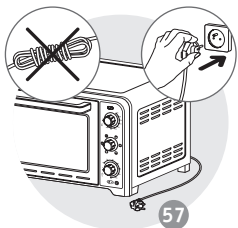

57

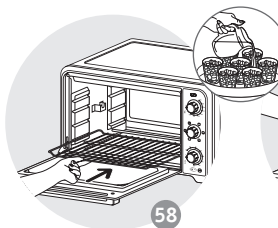

58

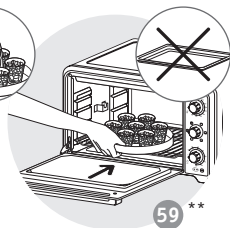

59 **

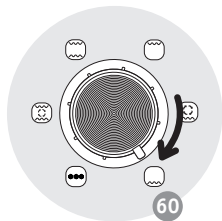

60

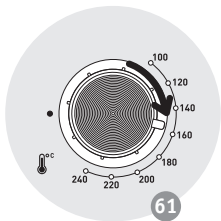

61

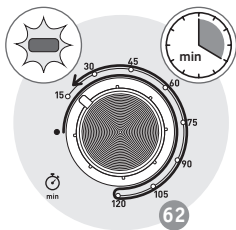

62

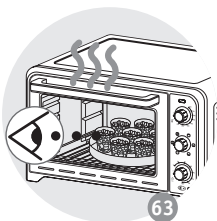

63

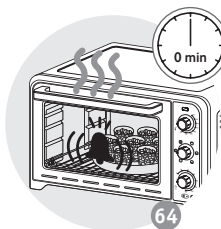

64

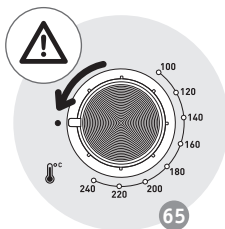

65

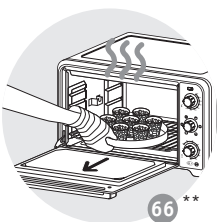

66 **

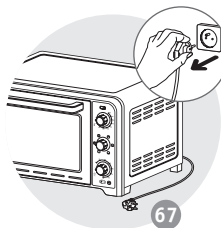

67

** Блюдо не входит в комплект поставки
Посуд не входит в комплект
Төрөлме құрылғымен бірге
қамтамасыз етілмейді
The dish is not supplied with the appliance

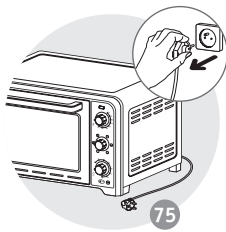
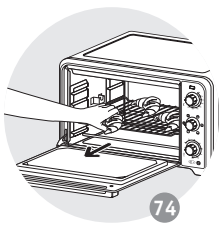
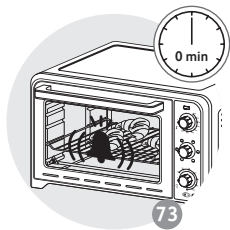
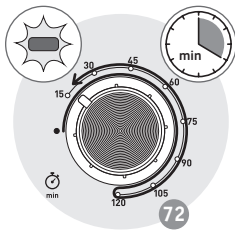
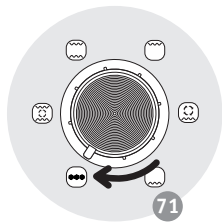
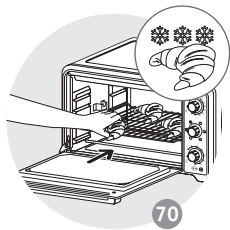
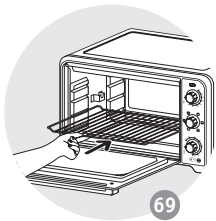
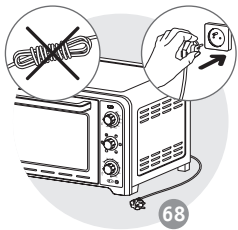

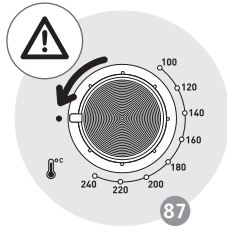
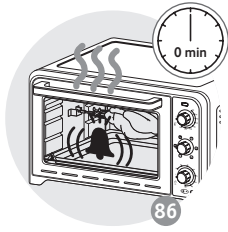
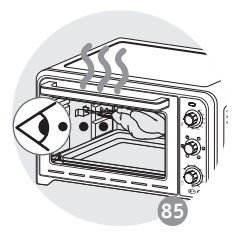
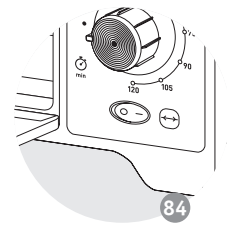
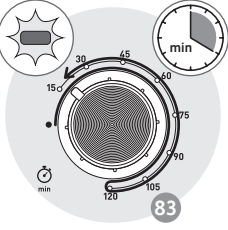
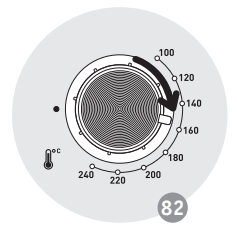
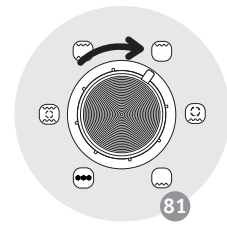
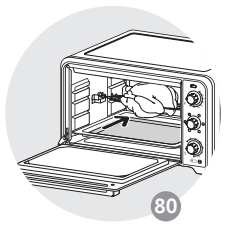
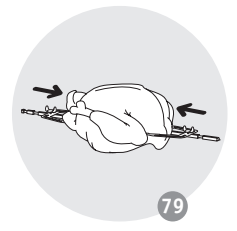
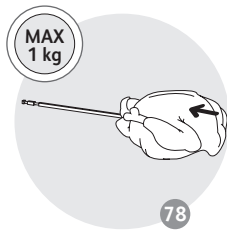
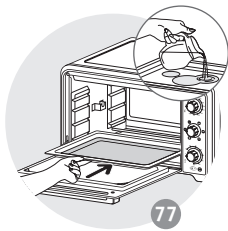
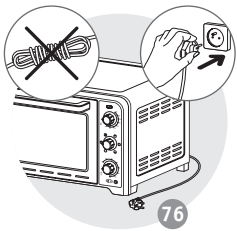

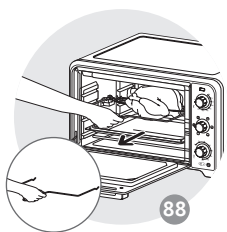

88

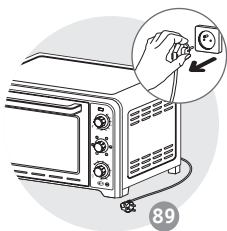

89

9

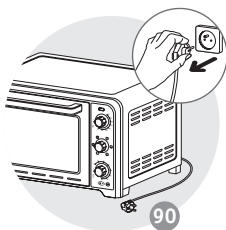

90

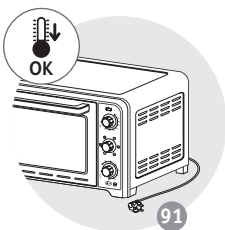

91

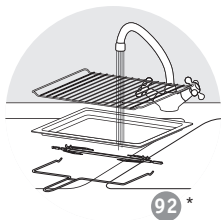

92 *

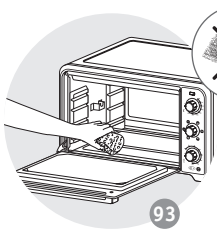

93

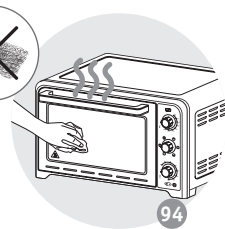

94

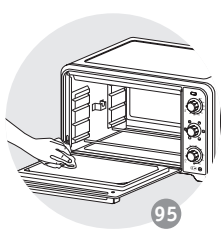

95

* в зависимости от модели - Комплектація в залежності від моделі - улігіє байланысты - depending on the model



	x4			10mins	240 °C	18 mins
	870g			10mins	230 °C	45 mins
	750g			10mins	240 °C	30 mins
	500g			-	240 °C	55 mins
	1000g			-	240 °C	80 mins
	x4			-	240 °C	22 mins
	x8			-	240 °C	15 mins
	350g			10mins	240 °C	25 mins
				10mins	240 °C	40 mins
	350g			10mins	240 °C	15 mins
				-	240 °C	25 mins
				10mins	200 °C	42 mins
				10mins	200 °C	22 mins
				10mins	200 °C	35 mins
	x6			10mins	150 °C	25 mins
	x6			10mins	200 °C	18 mins
				10mins	230 °C	55 mins
				10mins	240 °C	25 mins
	750g			-	240 °C	50 mins

